



EN

# SMART MAP PRO

Prog.Ver.T2.30

NVD-T002

DE

## OWNER'S MANUAL

Please read before using this disc.

FR

## MODE D'EMPLOI

Veuillez lire avant d'utiliser ce disque.

IT

## BEDIENUNGSANLEITUNG

Lesen Sie diese Bedienungsanleitung bitte vor Gebrauch der Disc.

## ISTRUZIONI PER L'USO

Si prega di leggere prima di utilizzare il disco.

ES

## MANUAL DE OPERACIÓN

Lea este manual antes de utilizar este disco.

## GEBRUIKSAANWIJZING

Lees de gebruiksaanwijzing zorgvuldig door alvorens u de disk in gebruik neemt.

NL

## ANVÄNDARHANDLEDNING

Läs igenom handledningen innan du använder den här skivan.

## BRUGERVEJLEDNING

Læs venligst denne vejledning for du tager denne DVD i brug.

SE

DK

# Table of Contents

## Connection

Connection with TMC-001P .....	3
--------------------------------	---

## TMC Operation (Optional)

Displaying the Traffic Event Information on Route .....	4
Displaying all Receiving Traffic event Information .....	5
Setting Dynamic Route Seek .....	5
Selecting the TMC Receiving .....	5
Setting the RDS-TMC Voice Guidance to Interrupt the Radio or CD, etc. ....	5

---

# Before Using the Disc

- **This Supplementary Owner's Manual explains about the newly added functions to the new-version (Prog. Ver. 2.30, Database Ver. 2.30) of the map disc.  
Please thoroughly read this Manual before starting operation.**
- **Operating System Programme Rewriting**
  - 1) Insert the upgrade disc into your INA-N033R.
  - 2) The operating system will automatically be rewritten.
- **The RDS-TMC receiver box TMC-001P can be connected to utilize RDS-TMC. For details of operation, please refer to the TMC-001P Owner's Manual.**

# Connection

## Connection with TMC-001P

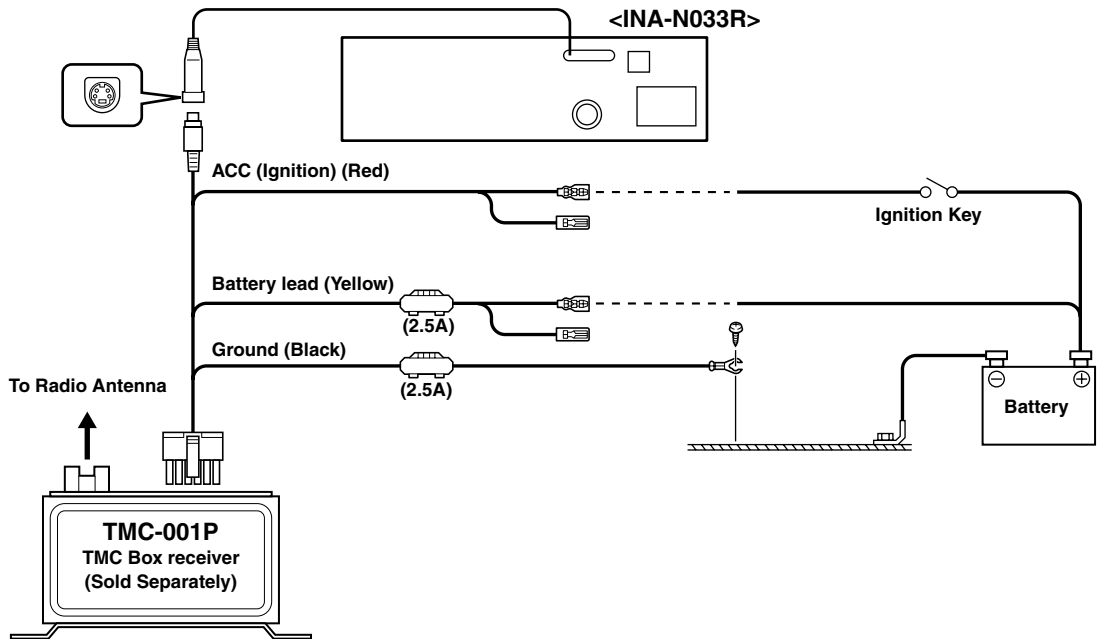



\* For further information about the connection and installation of TMC-001P, refer to the owner's manual of TMC-001P.

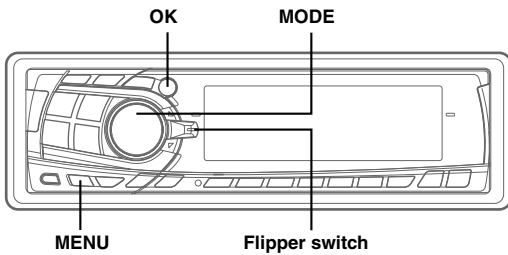





# TMC Operation (Optional)



## About the TMC indicator

 : receiving TMC  
 : not receiving TMC

## TMC icon

Symbol	Legend	Symbol	Legend
	Stationary traffic		Road works
	Traffic jam		Weather
	Accidents		Parking
	Closed road		

## Displaying the Traffic Event Information on Route

You can only use this function with the optional RDS-TMC receiver box TMC-001P connected.

- 1 After setting the route, press the **MENU** button to display "NAV.MENU."

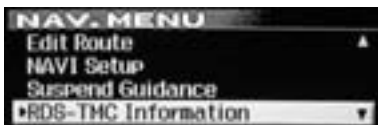

- 2 Select "RDS-TMC Information" from "NAV.MENU" by sliding the **Flipper switch** up or down. Press the **OK** button or **MODE** knob to execute the selection.
- 3 Select "Traffic On Route" from the "RDS-TMC Information" menu by sliding the **Flipper switch** up or down. Press the **OK** button or **MODE** knob to execute the selection.

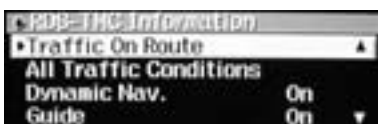

- 4 If there is any traffic event information on your set route, the information will be displayed. When there are more than one piece of information, slide the **Flipper switch** up or down to select the further information you want to know. Press the **OK** button or **MODE** knob to execute the selection.

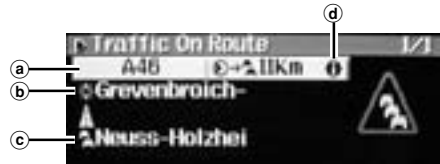

- (a) : Road name
- (b) : Destination place name of TMC event
- (c) : Starting place name of TMC event
- (d) : When this mark is displayed, "Detail Information" in step 5 will be displayed.

## Note

If the destination or starting place name is long, the whole name may not be displayed. It is not a malfunction.

- 5 Any further information is displayed. When there are more than one pieces of the traffic event information, slide the **Flipper switch** up or down to switch the further information you want to know.

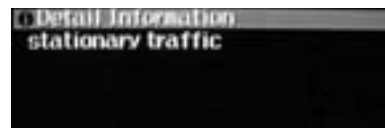

## Notes

- If there is no information on your set route, all other receiving information is displayed.
- While receiving the TMC and displaying your car's position, press the **OK** button for more than two seconds to display the traffic event information on your set route. If there is no information on your set route, all other receiving information is displayed.

## Displaying all Receiving Traffic event Information

- 1 In RDS-TMC Information Menu, slide the **Flipper switch** up or down to select "All Traffic Conditions." Press the **OK** button or **MODE** knob to execute the selection.
- 2 The display changes to "All Traffic Conditions" list. Slide the **Flipper switch** up or down to select the traffic event information you want to know. Press the **OK** button or **MODE** knob to execute the selection.

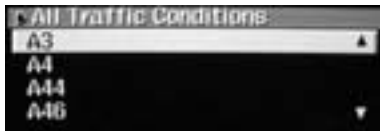

- 3 The traffic event information on the route that you selected is displayed. When there are more than one pieces of the traffic event information, slide the **Flipper switch** up or down to select the further information you want to know. Press the **OK** button or **MODE** knob to execute the selection.
- 4 Further information is displayed. When there are more than one piece of the further information, slide the **Flipper switch** up or down to display any further information.

### Note

While receiving the TMC and displaying your vehicle's position, press the **OK** button for more than two seconds to display the traffic event information on the route that you have set. If there is no information on the route that you have set, all other receiving information is displayed.

## Setting Dynamic Route Seek

- 1 In RDS-TMC Information Menu, slide the **Flipper switch** up or down to select "Dynamic Nav." Press the **OK** button or **MODE** knob to execute the selection.
- 2 The display changes to "Dynamic Nav." setting. Slide the **Flipper switch** up or down to select "On" or "Off." Press the **OK** button or **MODE** knob to execute the selection.

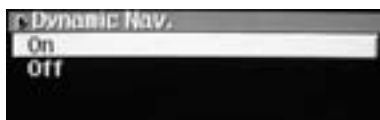

- 3 When you set to ON, a message regarding an evasion route is displayed while guiding the current route. Press the **Flipper switch** up and down to select "Yes," then press the **OK** button or **MODE** knob to execute the selection. The unit seeks for a route in consideration of the traffic event given through the RDS-TMS information and new guidance will be given.

### Note

When you set to OFF, the unit performs an initial seek for a route without consideration for any traffic event given through the RDS-TMC.

## Selecting the TMC Receiving

- 1 In RDS-TMC information Menu, slide the **Flipper switch** up and down to select "Set up RDS-TMC." Press the **OK** button to execute the selection.
- 2 The display changes to "Set up RDS-TMC." Slide the **Flipper switch** up and down to select "Country" or "Station." Press the **OK** button or **MODE** knob to execute the selection.

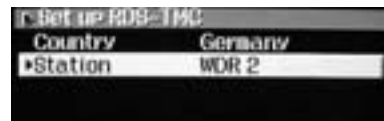

- 3 Slide the **Flipper switch** to select the name of the country or station you selected in step 2. Press the **OK** button or **MODE** knob to execute the selection. If you select "Auto," a station will be selected and received automatically.

### Note

If you select stations or countries listed as receivable in the list while you are in the area where these stations are not receivable, the TMC receiving is not functioned.

## Setting the RDS-TMC Voice Guidance to Interrupt the Radio or CD, etc.

- 1 In the RDS-TMC Information menu, slide the **Flipper switch** up and down to select "Guide." Press the **OK** button or **MODE** knob to execute the selection.
- 2 The display changes to the "Guide" setting display. Slide the **Flipper switch** up or down to select "On" or "Off."

On : TMC voice guidance will activate  
Off : No TMC voice guidance



- 3 Press the **OK** button or **MODE** knob to execute the selection.





**ALPINE ELECTRONICS MARKETING, INC.**

1-1-8 Nishi Gotanda,  
Shinagawa-ku, Tokyo 141-0031, Japan  
Phone 03-5496-8231

**ALPINE ELECTRONICS OF AMERICA, INC.**

19145 Gramercy Place, Torrance,  
California 90501, U.S.A.  
Phone 1-800-ALPINE-1 (1-800-257-4631)  
1-888-NAV-HELP (1-888-628-4357)

**ALPINE ELECTRONICS OF CANADA, INC.**

7300 Warden Ave., Suite 203, Markham,  
Ontario L3R 9Z6, Canada  
Phone 1-800-ALPINE-1 (1-800-257-4631)  
1-888-NAV-HELP (1-888-628-4357)

**ALPINE ELECTRONICS OF AUSTRALIA PTY. LTD.**

6-8 Fiveways Boulevard Keysborough,  
Victoria 3173, Australia  
Phone 03-9769-0000

**ALPINE ELECTRONICS GmbH**

Kreuzerkamp 7,  
40878 Ratingen, Germany  
Phone 02102-4550

**ALPINE ELECTRONICS OF U.K. LTD.**

Alpine House  
Fletchamstead Highway,  
Coventry CV4 9TW, U.K.  
Phone 0870-33 33 763

**ALPINE ELECTRONICS FRANCE S.A.R.L.**

(RCS PONTOISE B 338 101 280)  
98, Rue de la Belle Etoile, Z.I. Paris Nord II,  
B.P. 50016, 95945 Roissy Charles de Gaulle  
Cedex, France  
Phone 01-48638989

**ALPINE ITALIA S.p.A.**

Viale C. Colombo 8, 20090 Trezzano Sul  
Naviglio (MI), Italy  
Phone 02-484781

**ALPINE ELECTRONICS DE ESPAÑA, S.A.**

Portal de Gamarra 36, Pabellón, 32  
01013 Vitoria (Alava)-APDO 133, Spain  
Phone 945-283588

Yamagata Printing  
Co., Ltd.  
2-6-34, Takashima,  
Nishi-ku, Yokohama,  
Kanagawa, Japan

Designed by ALPINE Japan  
Printed in Japan (Y)  
68P50520Y77-O