



CDM-9807RB
CDM-9805R
CDM-9803RM
CDM-9803RR
CDM-9803R
CDE-9802RB
CDE-9801R

FM/MW/LW/RDS CD Receiver

- **OWNER'S MANUAL**
Please read before using this equipment.
- **BEDIENUNGSANLEITUNG**
Lesen Sie diese Bedienungsanleitung bitte vor Gebrauch des Gerätes.
- **MODE D'EMPLOI**
Veuillez lire avant d'utiliser cet appareil.
- **MANUAL DE OPERACIÓN**
Léalo antes de utilizar este equipo.
- **ISTRUZIONI PER L'USO**
Si prega di leggere prima di utilizzare l'attrezzatura.
- **ANVÄNDARHANDLEDNING**
Innan du använder utrustningen bör du läsa igenom denna användarhandledning.



ALPINE ELECTRONICS MARKETING, INC.
1-1-8 Nishi Gotanda,
Shinagawa-ku,
Tokyo 141-0031, Japan
Phone 03-5496-8231

ALPINE ELECTRONICS OF AMERICA, INC.
19145 Gramercy Place, Torrance,
California 90501, U.S.A.
Phone 1-800-ALPINE-1 (1-800-257-4631)

ALPINE ELECTRONICS OF CANADA, INC.
7300 Warden Ave., Suite 203, Markham,
Ontario L3R 9Z6, Canada
Phone 1-800-ALPINE-1 (1-800-257-4631)

ALPINE ELECTRONICS OF AUSTRALIA PTY. LTD.
6-8 Fiveways Boulevard Keysborough,
Victoria 3173, Australia
Phone 03-9769-0000

ALPINE ELECTRONICS GmbH
Kreuzerkamp 7,
40878 Ratingen, Germany
Phone 02102-4550

ALPINE ELECTRONICS OF U.K. LTD.
Alpine House
Fletchamstead Highway, Coventry CV4 9TW, U.K.
Phone 0870-33 33 763

ALPINE ELECTRONICS FRANCE S.A.R.L.
(RCS PONTOISE B 338 101 280)
98, Rue de la Belle Etoile, Z.I. Paris Nord II,
B.P. 50016, 95945 Roissy Charles de Gaulle
Cedex, France
Phone 01-48638989

ALPINE ITALIA S.p.A.
Viale C. Colombo 8, 20090 Trezzano Sul
Naviglio (MI), Italy
Phone 02-484781

ALPINE ELECTRONICS DE ESPAÑA, S.A.
Portal de Gamarra 36, Pabellón, 32
01013 Vitoria (Alava)-APDO 133, Spain
Phone 945-283588

EN

DE

FR

ES

IT

SE

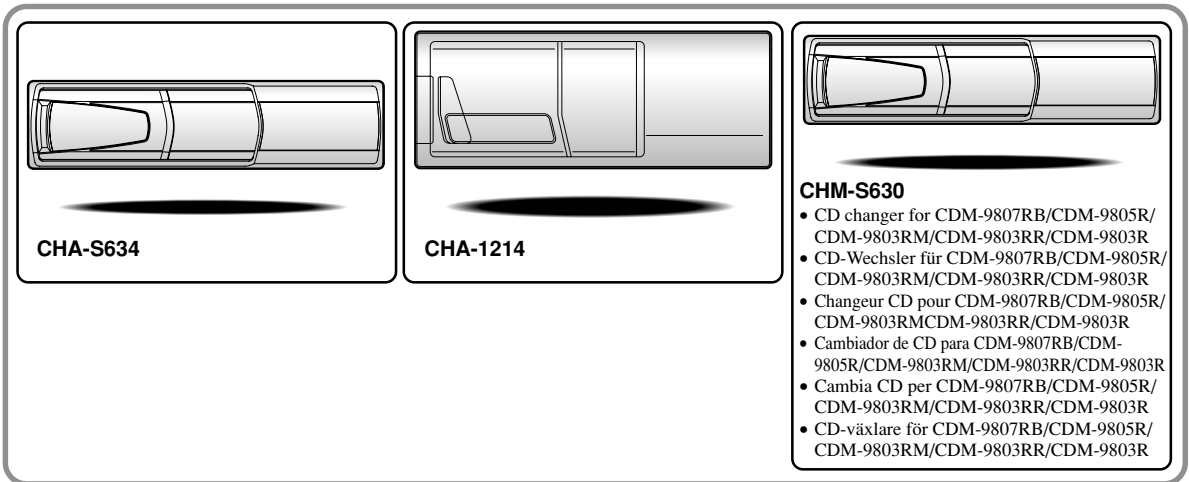

CHM-S630

- CD changer for CDM-9807RB/CDM-9805R/CDM-9803RM/CDM-9803RR/CDM-9803R
- CD-Wechsler für CDM-9807RB/CDM-9805R/CDM-9803RM/CDM-9803RR/CDM-9803R
- Changeur CD pour CDM-9807RB/CDM-9805R/CDM-9803RM/CDM-9803RR/CDM-9803R
- Cambiador de CD para CDM-9807RB/CDM-9805R/CDM-9803RM/CDM-9803RR/CDM-9803R
- Cambia CD per CDM-9807RB/CDM-9805R/CDM-9803RM/CDM-9803RR/CDM-9803R
- CD-växlare för CDM-9807RB/CDM-9805R/CDM-9803RM/CDM-9803RR/CDM-9803R

Alpine CD Changers Give You More!

More musical selections, more versatility, more convenience.

The CHA-S634 is a high-performance 6-disc changer with a new M DAC, CD-R/RW PLAY BACK, MP3 PLAY BACK and CD TEXT. The CHA-1214 Ai-NET model holds 12 discs, and the CHM-S630 M-Bus model is a super-compact 6-disc changer with a CD-R/RW PLAY BACK.

NOTE

The CHA-S634 model can be connected to the M-Bus model Head Unit using the optional M-Bus/Ai-NET compatible cable. (KCA-130B)

Von Alpine CD-Wechslern haben Sie mehr!

Mehr Musikauswahl, mehr Vielseitigkeit, mehr Komfort.

Der CHA-S634 ist ein Hochleistungs-Wechsler für 6 CDs mit dem neuen M-DAC, mit CD-R/RW- und MP3-Wiedergabefunktion und mit CD-TEXT. Der CHA-1214 ist ein Ai-NET-Modell für 12 CDs. Der M-Bus-kompatible CHM-S630 ist ein superkompakter Wechsler für 6 CDs mit CD-R/RW-Wiedergabefunktion.

HINWEIS

Das Modell CHA-S634 kann mit einem M-Bus-/Ai-NET-kompatiblen Kabel (KCA-130B) an das zusätzlich erhältliche M-Bus-Hauptgerät angeschlossen werden.

Changeurs de CD Alpine : vous avez le choix!

Plus de sélections musicales, plus de souplesse, plus de confort.

Le modèle CHA-S634 est un changeur 6 disques ultra performant équipé des nouvelles fonctions M DAC, CD-R/RW PLAY BACK, MP3 PLAY BACK et CD TEXT. Le modèle CHA-1214 Ai-NET contient 12 disques. Le modèle CHM-S630 M-Bus est un changeur 6 disques super compact doté de la fonction CD-R/RW PLAY BACK.

REMARQUE

Le modèle CHA-S634 peut être raccordé à l'appareil principal du modèle M-Bus en option à l'aide du câble compatible M-Bus/Ai-NET (KCA-130B).

¡Los cambiadores Alpine de CD le ofrecen más!

Más selecciones musicales, más versatilidad y más ventajas.

CHA-S634 es un cambiador de seis discos de alto rendimiento con nuevo M DAC, CD-R/RW PLAY BACK, MP3 PLAY BACK y CD TEXT. El modelo CHA-1214 Ai-NET alberga 12 discos y el modelo CHM-S630 M-Bus es un cambiador de seis discos de tamaño reducido con un CD-R/RW PLAY BACK.

NOTA

El modelo CHA-S634 se puede conectar a la unidad principal del modelo opcional M-Bus utilizando el cable compatible M-Bus/Ai-NET. (KCA-130B)

I caricatori CD Alpine danno di più!

Più scelta, più versatilità, più comodità.

Il modello CHA-S634 è un caricatore a 6 dischi ad elevate prestazioni dotato di un nuovo M DAC, CD-R/RW PLAY BACK, MP3 PLAY BACK e CD TEXT. Il modello CHA-1214 Ai-NET è in grado di contenere 12 dischi, il modello CHM-S630 M-Bus è un caricatore a 6 dischi ultra compatto dotato di un CD-R/RW PLAY BACK.

NOTA

Il modello CHA-S634 può essere collegato all'unità principale modello M-Bus mediante il cavo M-Bus/Ai-NET compatibile (KCA-130B).

Alpines CD-växlare ger mer!

Fler musikal, mer variation, större bekvämlighet.

CHA-S634 är en växlare för 6 skivor med mycket höga prestanda och en ny M D/A-omvandlare samt uppspelning av CD-R/RW, MP3 och CD TEXT. CHA-1214 Ai-NET rymmer 12 skivor. CHM-S630 M-Bus är en mycket kompakt växlare med kapaciteten 6 skivor med uppspelning av CD-R/RW PLAY BACK.

OBS!

CHA-S634 kan inte anslutas till M-Bus Huvudenhet (tillval) med en M-Bus/Ai-NET-kompatibel kabel. (KCA-130B)

Contents

Operating Instructions

WARNING

WARNING	2
CAUTION	2
PRECAUTIONS	2

Basic Operations

Detaching the Front Panel	4
Attaching the Front Panel	4
Initial System Start-Up	4
Turning Power On and Off	5
Adjusting Volume/Balance (Between Left and Right)/Fader (Between Front and Rear)	5
Turning Loudness On/Off	5
Audio Mute Function	5
Setting the Bass Control	6
Setting the Treble Control	6
Setting the Bass Type	7
Blackout Mode On and Off (CDM-9807RB only)	7
Changing Audio Level Display Pattern (CDM-9807RB/CDM-9805R only)	7
Changing Audio Level Display Pattern (CDM-9803RM/CDM-9803RR/CDM-9803R/CDE-9802RB/CDE-9801R only)	7

Radio Operations

Manual Tuning	8
Automatic Seek Tuning	8
Manual Storing of Station Presets	9
Automatic Memory of Station Presets	9
Tuning to Preset Stations	9

RDS Operations

Setting RDS Reception Mode and Receiving RDS Stations	10
Recalling Preset RDS Stations	10
Receiving RDS Regional (Local) Stations	11
Receiving Traffic Information	11
PTY (Programme Type) Tuning	11

Receiving Traffic Information While Playing CD or Radio	12
Priority News	12

CD Player Operations

Inserting/Ejecting Disc	13
Normal Play and Pause	14
Music Sensor (Skip)	14
Fast Forward and Backward	14
Repeat Play	14
M.I.X. (Random Play)	15
Scanning Programmes	15
Controlling CD Changer (Optional) (CDM-9807RB/CDM-9805R/CDM-9803RM/CDM-9803RR/CDM-9803R only)	15

SETUP Operations

Subwoofer On and Off	16
Adjusting Source Signal Levels	16
Setting the AUX Mode (CDM-9807RB/CDM-9805R/CDM-9803RM/CDM-9803RR/CDM-9803R only)	16
Switching the Tuner Mode (CDM-9807RB/CDM-9805R only)	17

Information

In Case of Difficulty	18
Specifications	19

Installation and Connections

Warning	20
Caution	20
Precautions	20
Installation	21
Connection	22

WARNING

WARNING

This symbol means important instructions. Failure to heed them can result in serious injury or death.

DO NOT OPERATE ANY FUNCTION THAT TAKES YOUR ATTENTION AWAY FROM SAFELY DRIVING YOUR VEHICLE.

Any function that requires your prolonged attention should only be performed after coming to a complete stop. Always stop the vehicle in a safe location before performing these functions. Failure to do so may result in an accident.

KEEP THE VOLUME AT A LEVEL WHERE YOU CAN STILL HEAR OUTSIDE NOISE WHILE DRIVING.

Failure to do so may result in an accident.

DO NOT DISASSEMBLE OR ALTER.

Doing so may result in an accident, fire or electric shock.

USE ONLY IN CARS WITH A 12 VOLT NEGATIVE GROUND.

(Check with your dealer if you are not sure.) Failure to do so may result in fire, etc.

KEEP SMALL OBJECTS SUCH AS BATTERIES OUT OF THE REACH OF CHILDREN.

Swallowing them may result in serious injury. If swallowed, consult a physician immediately.

USE THE CORRECT AMPERE RATING WHEN REPLACING FUSES.

Failure to do so may result in fire or electric shock.

DO NOT BLOCK VENTS OR RADIATOR PANELS.

Doing so may cause heat to build up inside and may result in fire.

USE THIS PRODUCT FOR MOBILE 12V APPLICATIONS.

Use for other than its designed application may result in fire, electric shock or other injury.

DO NOT PLACE HANDS, FINGERS OR FOREIGN OBJECTS IN INSERTION SLOTS OR GAPS.

Doing so may result in personal injury or damage to the product.

CAUTION

This symbol means important instructions. Failure to heed them can result in injury or material property damage.

HALT USE IMMEDIATELY IF A PROBLEM APPEARS.

Failure to do so may cause personal injury or damage to the product. Return it to your authorized Alpine dealer or the nearest Alpine Service Centre for repairing.

PRECAUTIONS

Temperature

Be sure the temperature inside the vehicle is between +60°C (+140°F) and -10°C (+14°F) before turning your unit on.

Moisture Condensation

You may notice the CD playback sound wavering due to condensation. If this happens, remove the disc from the player and wait about an hour for the moisture to evaporate.

Damaged Disc

Do not attempt to play cracked, warped, or damaged discs. Playing a bad disc could severely damage the playback mechanism.

Maintenance

If you have problems, do not attempt to repair the unit yourself. Return it to your Alpine dealer or the nearest Alpine Service Station for servicing.

Never Attempt the Following

Do not grip or pull out the disc while it is being pulled back into the player by the automatic reloading mechanism.

Do not attempt to insert a disc into the unit when the unit power is off.

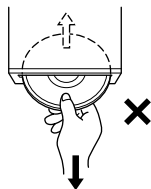

Inserting Discs

Your player accepts only one disc at a time for playback.

Do not attempt to load more than one disc.

Make sure the label side is facing up when you insert the disc. Your player will automatically eject any disc that is inserted incorrectly. If the player continues to eject a correctly inserted disc, push the Reset switch with a pointed object such as a ballpoint pen.

Playing a disc while driving on a very bumpy road may result in skips, but this will not scratch the disc or damage the player.

New Discs

As a protective measure to prevent the CD from jamming, the CD player will automatically eject discs with irregular surfaces or inserted incorrectly. When a new disc is inserted into the player and ejected after initial loading, using your finger, feel around the inside of the centre hole and outside edge of the disc. If you feel any small bumps or irregularities, this could inhibit proper loading of the disc. To remove the bumps, rub the inside edge of the hole and outside edge of the disc with a ballpoint pen or other such instrument, then insert the disc again.

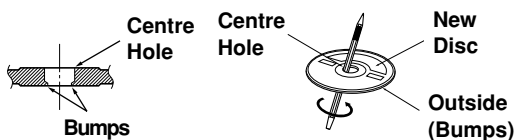

Irregular Shaped Discs

Be sure to use round shape discs only for this unit and never use any special shape discs.

Use of special shape discs may cause damage to the mechanism.



Installation Location

Make sure this unit will not be installed in a location subjected to:

- Direct sun and heat
- High humidity and water
- Excessive dust
- Excessive vibrations

Handling the Detachable Front Panel

- Do not expose to rain or water.
- Do not drop or apply shock.

Correct Handling

Do not drop the disc while handling. Hold the disc by its edge so that no fingerprints are left on the surface. Do not affix tape, paper, or gummed labels to the disc. Do not write on the disc.



INCORRECT



CORRECT



CORRECT



Disc Cleaning

Fingerprints, dust, or soil on the surface of the disc could cause the CD player to skip. For routine cleaning, wipe the playing surface with a clean, soft cloth from the centre of the disc to the outer edge. If the surface is heavily soiled, dampen a clean, soft cloth in a solution of mild neutral detergent before cleaning the disc.



Disc Accessories

There are various accessories available on the market for protecting the disc surface and improving sound quality. However, most of them will influence the thickness and/or diameter of the disc. Using such accessories can cause the disc to be out of standard specifications and may create operational problems. We recommend not using these accessories on discs played in Alpine CD players.

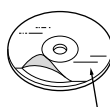

Transparent Sheet

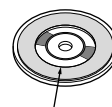

Disc Stabilizer

Basic Operations

(CDM-9807RB/CDM-9805R)

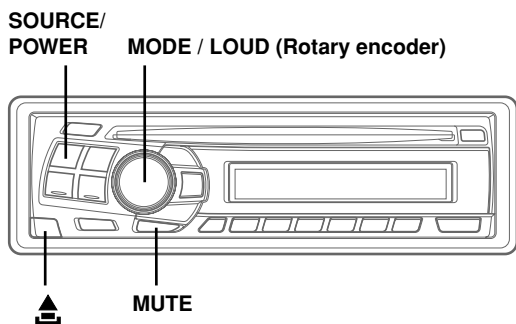

(CDM-9803RM/CDM-9803RR/CDM-9803R/CDE-9802RB/
CDE-9801R)

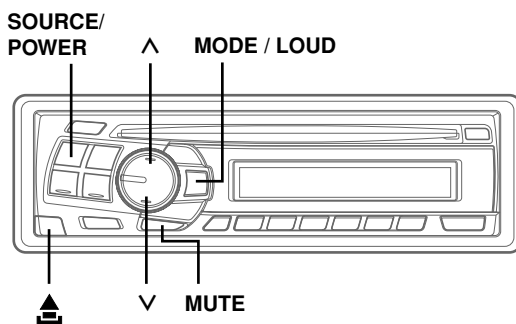

Detaching the Front Panel

- 1 Press and hold the **SOURCE/POWER** button for at least 3 seconds to turn off the power.
- 2 Press the ▲ (Release) button at lower left corner until the front panel pops out.
- 3 Grasp the left side of the front panel and pull it out.

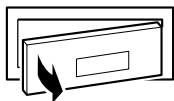

NOTES

- The front panel may become hot in normal usage (especially the connector terminals), this is not a malfunction.
- To protect the front panel, place it in the supplied carrying case.

Attaching the Front Panel

- 1 First, insert the right side of the front panel into the main unit. Align the groove on the front panel with the projection on the main unit.
- 2 Push the left side of the front panel until it locks firmly into the main unit.

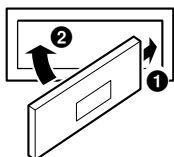

NOTE

Before attaching the front panel, make sure that there is no dirt or dust on the connector terminals and no foreign object between the front panel and the main unit.

• Controllable With Remote Control (CDM-9807RB/CDM-9805R/CDM-9803RM/ CDM-9803RR/CDM-9803R only)

This unit can be controlled with an optional Alpine remote control. For details, consult your Alpine dealer.

Point the optional remote control transmitter at the remote control sensor.

Remote control sensor

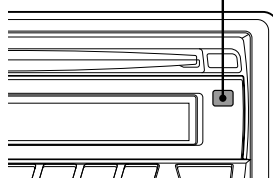

• Connectable to Remote Control Interface Box (CDM-9807RB/CDM-9805R/CDM-9803RM/ CDM-9803RR/CDM-9803R only)

You can operate this unit from the vehicle's control unit when an Alpine Remote Control Interface Box (optional) is connected. For details, contact your Alpine dealer.

Initial System Start-Up

- 1 Immediately after installing or applying power to the unit, it should be initialized. To do this, first, remove the detachable front panel. Behind the front panel, to the right of the connector, there is a small hole. Using a pencil or other pointed object, press the Reset switch mounted behind this hole to complete the initialization procedure.



Reset switch

Turning Power On and Off

- 1 Press the **SOURCE/POWER** button to turn on the unit.

NOTE

The unit can be turned on by pressing any other button except the eject \blacktriangle button.

The volume level gradually increases to the previous level you were listening to before the unit was turned off.

Press and hold the **SOURCE/POWER** button again for at least 3 seconds.

NOTE

The very first time the power is turned on, the volume will start from level 12, and the **LOUD** function will be on in the tuner mode.

Adjusting Volume/Balance (Between Left and Right)/Fader (Between Front and Rear)

- 1 Press the **MODE/LOUD** button repeatedly to choose the desired mode. Each press changes the modes as follows:

→ VOL → SUB-W* → BAL → FAD →

Volume: 0 ~ 35

Balance: L15 ~ R15

Fader: R15 ~ F15

Subwoofer: 0 ~ +15

NOTES

- If the Rotary encoder (CDM-9807RB/CDM-9805R only) is not turned or the \vee or \wedge button (CDM-9803RM/CDM-9803RR/CDM-9803R/CDE-9802RB/CDE-9801R only) is not pressed in 5 seconds after selecting the **BALANCE** and **FADER** modes, the unit automatically sets in the **VOLUME** mode.
- *When the subwoofer is set to **ON**, the level of the subwoofer can be adjusted.

- 2 Turn the **Rotary encoder** (CDM-9807RB/CDM-9805R only) or press the \vee and \wedge buttons (CDM-9803RM/CDM-9803RR/CDM-9803R/CDE-9802RB/CDE-9801R only) until the desired sound is obtained in each mode.

Turning Loudness On/Off

Loudness introduces a special low- and high-frequency emphasis at low listening levels. This compensates for the ear's decreased sensitivity to bass and treble sound.

- 1 Press and hold the **MODE/LOUD** button for at least 2 seconds to activate or deactivate the loudness mode. The display shows "LOUD ON" when the loudness mode is activated.

Audio Mute Function

Activating this function will instantly lower the volume level by 20 dB.

- 1 Press the **MUTE** button to activate the MUTE mode. The audio level will decrease by about 20 dB. Pressing the MUTE button again will bring the audio back to its previous level.

Indicators on the CDM-9807RB/CDM-9805R/CDM-9803R

LD FUNC RPT ALL M.I.X. DX SEEK AF T.INFO NEWS TP EON

The underline is lit when the function is activated.

Basic Operations

(CDM-9807RB/CDM-9805R)

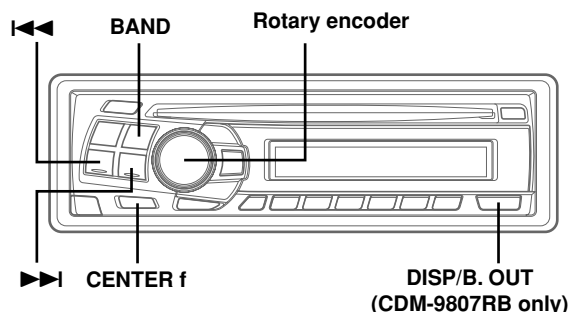

(CDM-9803RM/CDM-9803RR/CDM-9803R/CDE-9802RB/CDE-9801R)

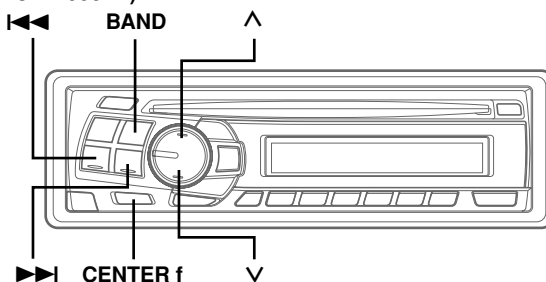

Setting the Bass Control

You can change the Bass Frequency emphasis to create your own tonal preference.

- 1 Press the **CENTER f** button to select the Bass setting mode. Each press changes the modes as follows.

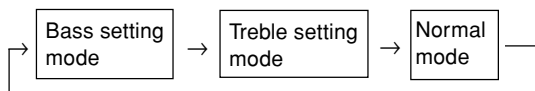

- 2-1* **Setting the Bass frequency:**
Press the **◀◀** or **▶▶** button to select the desired Bass centre frequency.
60Hz ↔ 80Hz ↔ 100Hz ↔ 200Hz
Emphasizes the displayed Bass frequency ranges.

- 2-2* **Setting the Bass Band Width (Q-Factor):**
Press the **BAND** button to select the desired Bass Band Width.

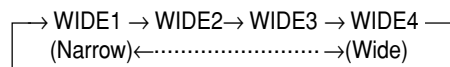

Changes the displayed frequency's band width to narrow or wide.

- 2-3 **Setting the Bass Level:**
Turn the **Rotary encoder** (CDM-9807RB/CDM-9805R only) or press the **∇** or **▲** button (CDM-9803RM/CDM-9803RR/CDM-9803R/CDE-9802RB/CDE-9801R only) to select the desired Bass Level (-7~+7).
You can emphasize or weaken the bass frequency.

NOTES

- If no buttons are pressed within 15 seconds, the Bass control setting will be turned off automatically.

- The settings of the Bass Level will be individually memorized for each source (FM, MW (LW) and CD) until the setting is changed. Once you set Bass frequency and Bass Band Width for one of sources (FM, MW (LW) and CD), this setting becomes effective for all those sources.
- * Selecting any of the "Setting the Bass Types" (TYPE 1 through 3), temporarily replaces the custom settings you have made above.

Setting the Treble Control

You can change the Treble Frequency emphasis to create your own tonal preference.

- 1 Press the **CENTER f** button to select the Treble setting mode. Each press changes the modes as follows.

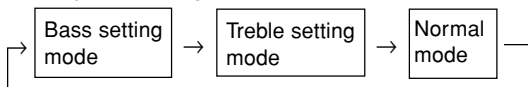

- 2-1 **Setting Treble frequency:**
Press **◀◀** or **▶▶** button to select the desired Treble centre frequency.
10kHz ↔ 12.5kHz ↔ 15kHz ↔ 17.5kHz
Emphasizes the displayed Treble frequency ranges.

- 2-2 **Setting Treble Level:**
Turn the **Rotary encoder** (CDM-9807RB/CDM-9805R only) or press the **∇** or **▲** button (CDM-9803RM/CDM-9803RR/CDM-9803R/CDE-9802RB/CDE-9801R only) to select the desired Treble Level (-7~+7).
You can emphasize the treble frequency.

NOTES

- If no buttons are pressed within 15 seconds, the Treble control setting will be turned off automatically.
- The settings of the Treble Level will be individually memorized for each source (FM, MW (LW) and CD) until the setting is changed. Once you set Treble frequency for one of sources (FM, MW (LW) and CD), this setting becomes effective for all those sources.

Setting the Bass Type

This function allows for 3 different Bass type settings. Select the one that appeals to you the most.

- 1 Press and hold the **CENTER f** button for at least 2 seconds to set the Bass type.
- 2 Select the desired TYPE (1 through 3) by pressing the **◀◀** or **▶▶** button within 15 seconds.
Type 1 will sound best if you have a subwoofer in your system. Use Type 2 or 3 if you are using small diameter speakers.
- 3 Press the **CENTER f** button for at least 2 seconds to return to the normal mode.

NOTES

- “Bass Center Frequency” and “Bass Band Width” previously set are replaced when selecting TYPE 1 through 3. When Bass Type is OFF, your previous settings are restored.
- If you connect an external audio processor, the setting cannot be carried out.

Blackout Mode On and Off (CDM-9807RB only)

When the Blackout mode is turned on, the display will turn off to reduce power consumption. This additional power enhances the sound quality.

- 1 Press and hold the **DISP/B.OUT** button for at least 3 seconds to start the blackout mode. By doing so the display will turn off.
NOTE
If any button on the unit is pressed during the blackout mode, the function will be displayed for 5 seconds to show the operation before returning to Blackout mode.
To cancel the blackout mode, press and hold the **DISP/B.OUT** button for at least 3 seconds.

Changing Audio Level Display Pattern (CDM-9807RB/CDM-9805R only)

- 1 Press the **DISP** button to switch the display pattern.
→ DISP1 → DISP2 → DISP OFF →
DISP1:
Lights the Volume indicator.
DISP2:
Lights the mode and value bars to show the settings in the Bass engine display.
DISP OFF:
Turns off the light in Audio Level display.
If you set DISP OFF, the Volume indicator and Bass engine displays are not lit at all times.

Changing Audio Level Display Pattern (CDM-9803RM/CDM-9803RR/CDM-9803R/CDE-9802RB/CDE-9801R only)

- 1 Press and hold the **F/SETUP** button for at least 3 seconds.
- 2 Press the **◀◀** or **▶▶** button to select DISP.
- 3 Press the **BAND** button to switch the display pattern.
→ DISP1 → DISP2 → DISP OFF →
DISP1:
Lights the Volume indicator.
DISP2:
Lights the mode and value bars to show the settings in the Bass engine display.
DISP OFF:
Turns off the light in Audio Level display.
If you set DISP OFF, the Volume indicator and Bass engine displays are not lit at all times.
- 4 When the setting is completed, press the **F/SETUP** button to return to the normal mode.

Radio Operations

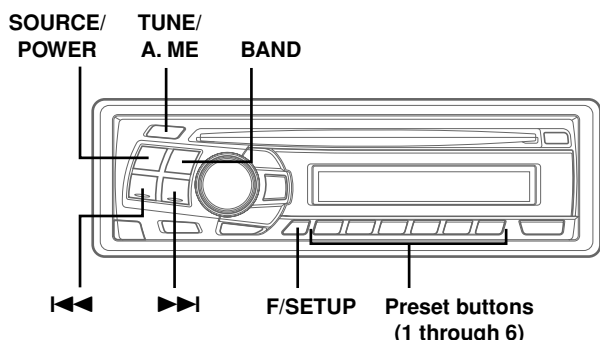

Manual Tuning

- 1 Press the **SOURCE/POWER** button to select the radio mode.
- 2 Press the **BAND** button repeatedly until the desired radio band is displayed. Each press changes the band:
→ F1(FM1) → F2(FM2) → MW → LW
- 3 Press the **TUNE/A. ME** button repeatedly until "DX SEEK" and "SEEK" disappear from the display.
NOTE
The initial mode is DX SEEK.
- 4 Press the **◀◀** or **▶▶** button to move downward or upward one step respectively until the desired station frequency is displayed.

NOTE

The ST indicator appears on the display when a Stereo FM station is tuned in.

Automatic Seek Tuning

- 1 Press the **SOURCE/POWER** button to select the radio mode.
- 2 Press the **BAND** button repeatedly until the desired radio band is displayed. Each press changes the band:
→ F1(FM1) → F2(FM2) → MW → LW
- 3 Press the **TUNE/A. ME** button to illuminate the DX and SEEK indicators in the display. The SEEK indicator illuminates. With the DX mode activated, both strong and weak stations will be tuned in the Auto-Seek operation. Press again to return to the local mode. The DX indicator will turn off and the SEEK indicator will illuminate for a few seconds. Now, only strong stations will be tuned.
- 4 Press the **◀◀** or **▶▶** button to automatically seek a station downward or upward respectively. The unit will stop at the next station it finds. Press the same button again to seek the next station.

Manual Storing of Station Presets

- 1 Select the radio band and tune in a desired radio station you wish to store in the preset memory.
- 2 Press the **F/SETUP** button so that the "FUNC" indicator light goes out. Press and hold the **Preset buttons (1 through 6)** that you want to store the station on for at least 2 seconds. The selected station is stored. The display shows the band, preset No. and station frequency memorized.
- 3 Repeat the procedure to store up to 5 other stations onto the same band. To use this procedure for other bands, simply select the band desired and repeat the procedure. A total of 24 stations can be stored in the preset memory (6 stations for each band; FM1, FM2, MW and LW).

NOTE

If you store a station in a preset memory which already has a station, the current station will be cleared and replaced with the new station.

Automatic Memory of Station Presets

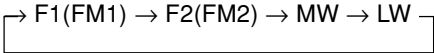
- 1 Press the **BAND** button repeatedly until the desired radio band is displayed. Each press changes the band:

- 2 Press and hold the **TUNE/A. ME** button for at least 2 seconds. The tuner will automatically seek and store 6 strong stations in the selected band in order of signal strength. The frequency on the display continues to change while the automatic memory is in progress. When the automatic memory has been completed, the tuner goes to the station stored in the preset location No. 1.

NOTE

If no stations are stored, the tuner will return to the original station you were listening to before the auto memory procedure began.

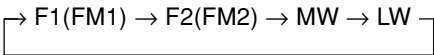
Tuning to Preset Stations

- 1 Press the **BAND** button repeatedly until the desired band is displayed. Each press changes the band:

- 2 Press the **F/SETUP** button so that the "FUNC" indicator light goes out. Then press the station preset button that has your desired radio station in memory. The display shows the band, preset number and frequency of the station selected.

Indicators on the CDM-9807RB/CDM-9805R/CDM-9803R

LD FUNC RPT ALL M.I.X. DX SEEK AF T.INFO NEWS TP EON

The underline is lit when the function is activated.

RDS Operations

(CDM-9807RB/CDM-9805R)

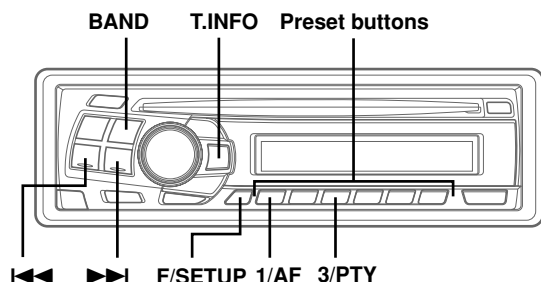

(CDM-9803RM/CDM-9803RR/CDM-9803R/CDE-9802RB/CDE-9801R)

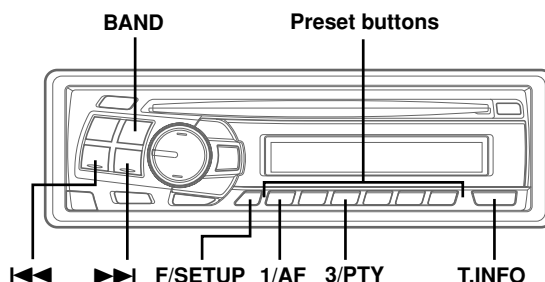

Setting RDS Reception Mode and Receiving RDS Stations

The RDS (Radio Data System) is a radio information system using the 57 kHz subcarrier of regular FM broadcasts. The RDS allows you to receive a variety of information such as traffic information, station names, and to automatically re-tune to a stronger transmitter that is broadcasting the same programme.

- 1 Press the **F/SETUP** button so that the "FUNC" indicator lights up.
- 2 Press the **1/AF** button to activate the RDS mode.
- 3 Press the **◀◀** or **▶▶** button to tune in the desired RDS station.

NOTE

When the **BAND** button is pressed and held for more than 2 seconds while a station name is displayed, the display shows the station frequency for 5 seconds.

- 4 Press the **1/AF** button again to deactivate the RDS mode.
- 5 Press the **F/SETUP** button to activate the normal mode.
The "FUNC" indicator light goes out.

Tips

The RDS digital data includes the following:

PI	Programme Identification
PS	Programme Service Name
AF	List of Alternative Frequencies
TP	Traffic Programme
TA	Traffic Announcement
PTY	Programme Type
EON	Enhanced Other Networks

Recalling Preset RDS Stations

- 1 Press the **F/SETUP** button so that the "FUNC" indicator lights up.
- 2 Press the **1/AF** button to activate the RDS mode.
- 3 Press the **F/SETUP** button to activate the normal mode.
The "FUNC" indicator light goes out.
- 4 Make sure that the "FUNC" indicator light goes out, then press the **preset button** in which your desired RDS station is preset.
If the preset station's signal is weak, the unit automatically searches and tunes to a stronger station in the AF (Alternative Frequencies) list.
- 5 If the preset station and the stations in the AF list cannot be received:
Press the same **preset button** again within 5 seconds to have the unit search for a station in the PI (Programme Identification) list.
If there are still no stations receivable in the area, the unit displays the frequency of the preset station and the preset indicator disappears.
If the signal level of the Regional (Local) station being tuned becomes too weak to receive, press the same **preset button** to tune in a Regional station in other district.

NOTE

For presetting the RDS stations, refer to the Radio Operation section. The RDS stations can be preset in the F1 and F2 bands only.

Receiving RDS Regional (Local) Stations

- 1 Press and hold the **F/SETUP** button for at least 3 seconds to activate the setting mode.
- 2 Press the **◀◀** or **▶▶** button to select the REG mode.
- 3 Press the **BAND** button to turn on or off the REG (Regional) mode.
In the REG OFF mode, the unit automatically keeps receiving the related local RDS station.
- 4 Press the **F/SETUP** button to deactivate the setting mode.

Receiving Traffic Information

- 1 Press the **T.INFO** button repeatedly until the T.INFO indicator appears in the display.
- 2 Press the **◀◀** or **▶▶** button to select your desired traffic information station. When a traffic information station is tuned in, the TP indicator lights up.

Traffic information is heard only when it is being broadcast. If traffic information is not being broadcast, the unit is set in the standby mode. When a traffic information broadcast begins, the unit automatically receives it and the display shows "TRF-INFO" for a few seconds and returns to the PS display.

When the traffic information broadcast is over, the unit will automatically set in the standby mode.

NOTES

- If the traffic information broadcast signal falls below a certain level, the unit remains in the receiving mode for 1 minute. If the signal remains below a certain level for over 1 minute, the "T.INFO" indicator blinks.
- If you do not want to listen to the traffic information being received, lightly press the T.INFO button to skip that traffic information message. The T.INFO mode will remain in the ON position to receive the next traffic information message.
- If the volume level is changed while receiving traffic information, the changed volume level will be memorized. When traffic information is received next time, the volume level will be automatically adjusted to the level memorized.

PTY (Programme Type) Tuning

- 1 Press the **F/SETUP** button so that the "FUNC" indicator lights up.
- 2 Press the **3/PTY** button to activate the PTY mode, while the unit is in Radio (FM receiving) mode.
The Programme Type of the station being currently received will be displayed for 5 seconds.
 - If there is no receivable PTY broadcast, "NO PTY" will be displayed for 5 seconds.
 - If no RDS station can be received, the display shows "NO PTY."

NOTE

If no button is pressed within 5 seconds after pressing the PTY button, the PTY mode will be automatically cancelled.

- 3 Press the **◀◀** and **▶▶** buttons within 5 seconds after activating the PTY mode to choose the desired programme type while the PTY (programme type) is being displayed. Each press scrolls the programme type by one.
 ◀ - LIGHT M ← CLASSICS → OTHER M - ▶

- 4 Press the **3/PTY** button within 5 seconds after selecting the programme type to start searching for a station in the selected programme type. The chosen programme type indicator blinks during searching and lights when a station is found.
If no PTY station is found, "NO PTY" will be displayed for 2 seconds.
- 5 Press the **F/SETUP** button to activate the normal mode.
The "FUNC" indicator light goes out.

Indicators on the CDM-9807RB/CDM-9805R/CDM-9803R

LD FUNC RPT ALL M.I.X. DX SEEK AF T.INFO NEWS TP EON

The underline is lit when the function is activated.

RDS Operations

(CDM-9807RB/CDM-9805R)

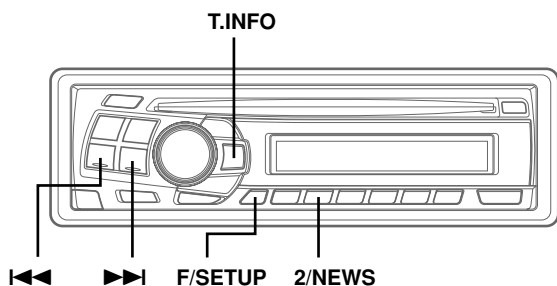

(CDM-9803RM/CDM-9803RR/CDM-9803R/CDE-9802RB/CDE-9801R)

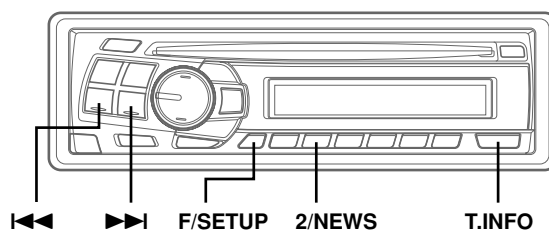

Receiving Traffic Information While Playing CD or Radio

- 1 Press the **T.INFO** button repeatedly until the "T.INFO" indicator appears in the display.
- 2 Press the **◀◀** and **▶▶** buttons to select a traffic information station if necessary.
 - When a traffic information broadcast starts, the unit automatically mutes the CD player/ changer or the regular FM broadcast.
 - When the traffic information broadcast finishes, the unit automatically returns to the original source play before the traffic information broadcast began.

When traffic information stations cannot be received:

In the tuner mode:

When the TP signal can no longer be received for over 1 minute, the "T.INFO" indicator blinks.

In the CD mode:

When the TP signal can no longer be received, the traffic information station of another frequency will be selected automatically.

NOTE

The receiver is equipped with the EON (Enhanced Other Networks) function in order to keep track of additional alternate frequencies to the AF list. The EON indicator appears while an RDS EON station is being received. If the station being received does not broadcast the traffic information, the receiver automatically tunes in the related station that broadcasts the traffic information when it occurs.

- 3 Press the **T.INFO** button to deactivate the Traffic Information mode.
The "T.INFO" indicator disappears.

Priority News

This function allows you to preset to give priority to the News programme. You will never miss the News programme as the unit automatically gives priority to the News programme whenever it begins broadcasting, and interrupts the programme you are currently listening. This feature is functional when your unit is set to a mode other than the LW and MW modes.

- 1 Press the **F/SETUP** button so that the "FUNC" indicator lights up while the unit is in Radio (FM receiving) mode.
 - 2 Press the **2/NEWS** button to activate the PRIORITY NEWS mode.
The "NEWS" indicator appears in the display.
 - To disable the PRIORITY NEWS function, press the NEWS button.
- NOTE**
In the PRIORITY NEWS function, unlike in the T.INFO function, the volume does not increase automatically.
- 3 Press the **F/SETUP** button to activate the normal mode, while the unit is in Radio (FM receiving) mode.
The "FUNC" indicator light goes out.

CD Player Operations

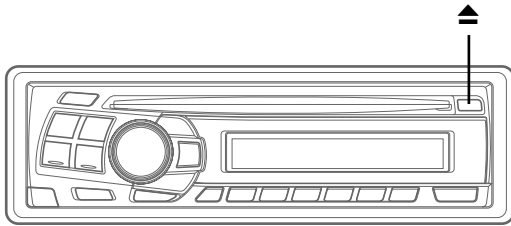

Inserting/Ejecting Disc

- 1 Insert a CD half way into the slot with the label side facing up. The player automatically draws the disc into the disc compartment.

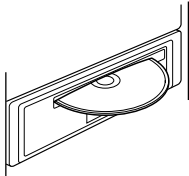

The Disc indicator appears to show that a disc is loaded.

NOTE

Three-inch (8cm) CD's can be used.

- 2 Press the ▲ button when you want to eject the CD.

NOTES

- If the CD is not removed for several seconds after it has been ejected, the player automatically draws the CD into the compartment to protect the CD.
- Do not insert or remove a CD when loading or ejecting a CD, as malfunction may result.

About the usable discs.

Use only compact discs with the label side showing the CD logo marks below.



If you use unspecified compact discs, correct performance cannot be guaranteed.

You can play CD-Rs (CD-Recordable)/CD-RWs (CD-ReWritable) for audio use on this unit. You can not also play CD-Rs/CD-RWs containing MP3 formatted audio files.

- Some of the following CDs may not play on this unit: Flawed CDs, CDs with fingerprints, CDs exposed to extreme temperatures or sunlight (e.g., left in the car or this unit), CDs recorded under unstable conditions, CDs not designed for audio use, CDs on which a recording failed a re-recording was attempted.

On handling Compact Discs (CD/CD-R/CD-RW)

- Do not touch the surface.
- Do not expose the disc to direct sunlight.
- Do not affix stickers or labels and do not write on the surface.
- Clean the disc when it is dusty.
- Make sure that there are no bumps around the disc.
- Do not use commercially available disc accessories.

Do not leave the disc in the car or the unit for a long time. Never expose the disc to direct sunlight.

Heat and humidity may damage the CD and you may not be able to play it again.

To customers using CD-R/CD-RW

- If a CD-R/CD-RW cannot be played back, make sure close session (finalization) has been performed.
- Finalize the CD-R/CD-RW if necessary, and attempt playback again.

Indicators on the CDM-9807RB/CDM-9805R/CDM-9803R

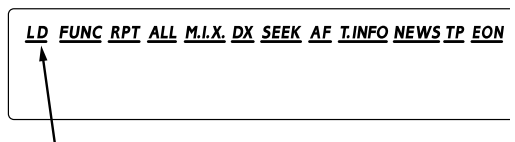

The underline is lit when the function is activated.

CD Player Operations

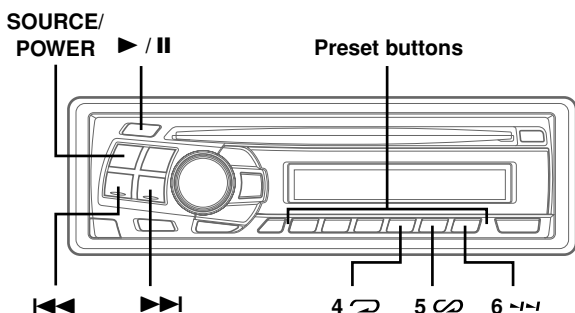

Music Sensor (Skip)

- 1 Momentarily press the **◀◀** button once during CD play to return to the beginning of the current track. If you wish to access a track further back, repeatedly press until you reach the desired track.

Press the **▶▶** button once to advance to the beginning of the next track. If you wish to access a track further ahead, press repeatedly until the desired track is reached.

NOTE

The music sensor feature is functional in the play or pause mode.

Normal Play and Pause

- 1 Insert a CD. The CD player begins playback from the first track on the disc.

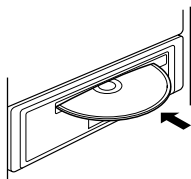

The display shows the track number. When the last track is played back the player returns to the first track.

- 2 If a disc is already loaded in the CD player, press the **SOURCE/POWER** button to select the CD mode.
- 3 Press the **▶/||** button to temporarily stop CD playback. To resume playback, press the **▶/||** button again.

Fast Forward and Backward

- 1 Press and hold the **◀◀** or **▶▶** button to quickly move backward or forward until you reach the desired section of the track.

Repeat Play

- 1 Press the **4 (↻)** button to play back repeatedly the track being played. The RPT indicator appears and the track will be played repeatedly.

Press the **4 (↻)** button again to deactivate the repeat play.

NOTES

- If a CD Changer is connected and the RPT ALL mode is selected, the unit repeatedly plays back all tracks on the disc selected (CDM-9807RB/CDM-9805R/CDM-9803RM/CDM-9803RR/CDM-9803R only).

→ RPT → RPT ALL → (OFF) →

- In case a 6-disc CD changer is connected (CDM-9807RB/CDM-9805R/CDM-9803RM/CDM-9803RR/CDM-9803R only):
Press the F/SETUP button so that the "FUNC" indicator lights up, then go to step 1.
Press the F/SETUP button to return to the normal mode.
The "FUNC" indicator light goes out.

M.I.X. (Random Play)

- 1 Press the **5** () button in the play or pause mode.
The M.I.X. indicator will illuminate and the tracks on the disc will be played back in a random sequence.

To cancel M.I.X. play, press the **5** () button again.

NOTE

In case a 6-disc CD changer is connected (CDM-9807RB/CDM-9805R/CDM-9803RM/CDM-9803RR/CDM-9803R only):

Press the F/SETUP button so that the "FUNC" indicator lights up, then go to step 1.

Press the F/SETUP button to return to the normal mode.

The "FUNC" indicator light goes out.

Scanning Programmes

- 1 Press the **6** () button to activate the Scan mode.
The first 10 seconds of each track will be played back in succession.

To stop scanning, press the **6** () button to deactivate the Scan mode.

NOTE

In case a 6-disc CD changer is connected (CDM-9807RB/CDM-9805R/CDM-9803RM/CDM-9803RR/CDM-9803R only):

Press the F/SETUP button so that the "FUNC" indicator lights up, then go to step 1.

Press the F/SETUP button to return to the normal mode.

The "FUNC" indicator light goes out.

Controlling CD Changer (Optional) (CDM-9807RB/CDM-9805R/CDM-9803RM/CDM-9803RR/CDM-9803R only)

If an optional Alpine 6-disc CD Changer is connected to the 8-pin DIN connector (M-Bus) of the CDM-9807RB/CDM-9805R/CDM-9803RM/CDM-9803RR/CDM-9803R, you can control the CD Changer using the CDM-9807RB/CDM-9805R/CDM-9803RM/CDM-9803RR/CDM-9803R.

NOTE

The CD controls on the CDM-9807RB/CDM-9805R/CDM-9803RM/CDM-9803RR/CDM-9803R for the CD Changer operation are functional only when the CD Changer is interconnected with the CDM-9807RB/CDM-9805R/CDM-9803RM/CDM-9803RR/CDM-9803R.

- 1 Press the **SOURCE/POWER** button to activate the CD Changer.

NOTE

To start play or pause play, press the  button.

- 2 Make sure that the "FUNC" indicator light goes out, then press the **Preset buttons** to select the desired disc loaded in the CD Changer.

NOTES

- After selecting the desired disc, you can operate in the same way as for the CD player.
For details, please see the CD Operation section.
- If the "FUNC" indicator is illuminated the Disc Select buttons become nonfunctional.

Indicators on the CDM-9807RB/CDM-9805R/ CDM-9803R

LD FUNC RPT ALL M.I.X. DX SEEK AF T.INFO NEWS TP EON

The underline is lit when the function is activated.

SETUP Operations

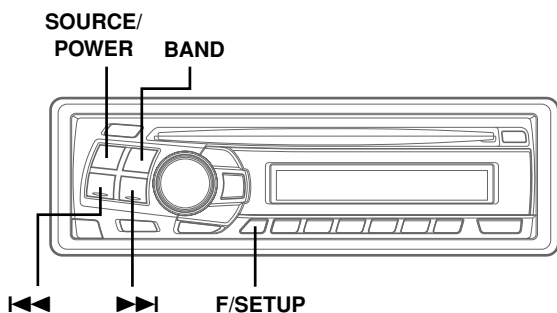

Subwoofer On and Off

- 1 Press and hold the **F/SETUP** button for at least 3 seconds.
- 2 Press the **◀◀** or **▶▶** button to select the SUB (Subwoofer) mode.
- 3 Press the **BAND** button to select Subwoofer ON or OFF.
- 4 After setting is completed, press the **F/SETUP** button to return to normal mode.

NOTES

- Initial mode is "SUB-W ON."
- Set to "SUBW OFF" unless the subwoofer is used.
- When the subwoofer is turned on, the subwoofer output level can be adjusted. For more details, refer to the Adjusting Volume/Balance/Fader.

Adjusting Source Signal Levels

If the difference in volume level between the CD player and FM radio is too great, adjust the FM signal level as follows.

- 1 Press and hold the **F/SETUP** button for at least 3 seconds.
- 2 Press the **◀◀** or **▶▶** button to select the FM LV (FM LEVEL) mode.
- 3 Press the **BAND** button to select the FM signal level HI (High) or LO (Low) to make the signal levels between the FM band and CD player closer.
- 4 Press the **F/SETUP** button to return to normal mode.

Setting the AUX Mode (CDM-9807RB/CDM-9805R/CDM-9803RM/CDM-9803RR/CDM-9803R only)

You can input TV/video sound by connecting an optional "M-Bus V-Link" (M-Bus/RCA interface cable KCM-122B) to this component.

- 1 Press and hold the **F/SETUP** button for at least 3 seconds.
- 2 Press the **◀◀** or **▶▶** button to select the AUX mode.
- 3 Press the **BAND** button to toggle the mode between AUX ON and AUX OFF.
- 4 Press the **F/SETUP** button to return to normal mode.
- 5 To adjust the volume, etc., first press the **SOURCE/POWER** button and select the AUX mode, then make the necessary adjustment.

→ TUNER → CD → AUX →

NOTE

When AUX ON is selected, a CD Changer cannot be used.

Switching the Tuner Mode (CDM-9807RB/CDM-9805R only)

The CDM-9807RB/CDM-9805R incorporates the MAX TUNE Pro for the highest quality tuner audio. Moreover, you can choose between 3 settings to suit your own personal sound preferences usage.

- 1 Press and hold the **F/SETUP** button for at least 3 seconds.
- 2 Press the **◀◀** or **▶▶** button to select NORMAL.

- 3 Press the **BAND** button to switch the TUNER mode.

→ HI-FI → NORMAL → STABLE →

NORMAL: Standard setting

HI-FI: Sound quality priority setting

STABLE: Noiseless priority setting

NOTES

- The initial setting at the factory is "NORMAL."
- If you find the sound is very noisy while listening to the tuner in the HI-FI mode, we recommend you change to the NORMAL mode.

- 4 When the setting is completed, press the **F/SETUP** button to return to the normal mode.

Information

In Case of Difficulty

If you encounter a problem, please turn the power off, then on again. If the unit is still not functioning normally, please review the items in the following checklist. This guide will help you isolate the problem if the unit is at fault. Otherwise, make sure the rest of your system is properly connected or consult your authorized Alpine dealer.

Basic

No function or display.

- Vehicle's ignition is off.
 - If connected following instructions, the unit will not operate with the vehicle's ignition off.
 - Improper power lead connections.
 - Check power lead connections.
 - Blown fuse.
 - Check the fuse on the battery lead of the unit; replace with the proper value if necessary.
 - Internal micro-computer malfunctioned due to interference noise etc.
 - Press the Reset switch with a ballpoint pen or other pointed article.
-

Radio

Unable to receive stations.

- No antenna or open connection in cable.
 - Make sure the antenna is properly connected; replace the antenna or cable if necessary.

Unable to tune stations in the seek mode.

- You are in a weak signal area.
 - Make sure the tuner is in the DX mode.
- If the area you are in is a primary signal area, the antenna may not be grounded and connected properly.
 - Check your antenna connections; make sure the antenna is properly grounded at its mounting location.
- The antenna may not be the proper length.
 - Make sure the antenna is fully extended; if broken, replace the antenna with a new one.

Broadcast is noisy.

- The antenna is not the proper length.
 - Extend the antenna fully; replace it if it is broken.
 - The antenna is poorly grounded.
 - Make sure the antenna is grounded properly at its mounting location.
-

CD

CD Player/Changer (CDM-9807RB/CDM-9805R/CDM-9803RM/CDM-9803RR/CDM-9803R only) not functioning.

- Out of operating temperature range +50°C (+120°F) for CD.
 - Allow the vehicle's interior (or trunk) temperature to cool.

CD playback sound is wavering.

- Moisture condensation in the CD Module.
 - Allow enough time for the condensation to evaporate (about 1 hour).

CD insertion not possible.

- The CD is already in the CD player.
 - Eject the CD and remove it.
- The CD is being improperly inserted.
 - Make sure the CD is being inserted following instructions in the CD Player Operation section.

Unable to fast forward or backward the CD.

- The CD has been damaged.
 - Eject the CD and discard it; using a damaged CD in your unit can cause damage to the mechanism.

CD playback sound skips due to vibration.

- Improper mounting of the unit.
 - Securely re-mount the unit.
- Disc is very dirty.
 - Clean the disc.
- Disc has scratches.
 - Change the disc.
- The pick-up lens is dirty.
 - Do not use a commercial available lens cleaner disc. Consult your nearest ALPINE dealer.

CD playback sound skips without vibration.

- Dirty or scratched disc.
 - Clean the disc; damaged disc should be replaced.

Error displays (built-in CD player only)

- Mechanical error
 - Press the ▲ button. After the error indication disappears, insert the disc again. If the above-mentioned solution does not solve the problem, consult your nearest ALPINE dealer.
-

Indication for CD

HI TEMP

- Protective circuit is activated due to high temperature.
 - The indicator will disappear when the temperature returns to within operation range.

ERROR

- Mechanism error.
 1. Press the **▲** button and eject the CD.
If not ejecting, consult your Alpine dealer.
 2. When the error indication remains after ejecting, press the **▲** button again.
If the error indication still does not turn off after pressing the **▲** button for a few times, consult your Alpine dealer.

Note

When the "ERROR" is displayed:

In case that the disc cannot be ejected by pressing the **▲** button, press the Reset switch (refer to page 4) and press the **▲** button again.

If not ejecting, consult your Alpine dealer.

NO DISC

- No CD is inserted.
 - Insert a CD.

Indication for CD Changer (CDM-9807RB/CDM-9805R/CDM-9803RM/CDM-9803RR/CDM-9803R only)

HI TEMP

- Protective circuit is activated due to high temperature.
 - The indicator will disappear when the temperature returns to within operation range.

ERROR - 01

- Malfunction in the CD Changer.
 - Consult your Alpine dealer. Press the magazine eject button and pull out the magazine.
Check the indication. Insert the magazine again.
If the magazine cannot be pulled out, consult your Alpine dealer.
- Magazine ejection not possible.
 - Press the magazine eject button. If the magazine does not eject, consult your Alpine dealer.

NO MAGZN

- No magazine is loaded into the CD Changer.
 - Insert a magazine.

NO DISC

- No indicated disc.
 - Choose another disc.

Specifications

FM TUNER SECTION

Tuning Range	87.5 – 108.0 MHz
Mono Usable Sensitivity	0.7 μ V
Alternate Channel Selectivity	80 dB
Signal-to-Noise Ratio	65 dB
Stereo Separation	35 dB
Capture Ratio	2.0 dB

MW TUNER SECTION

Tuning Range	531 – 1,602 kHz
Sensitivity (IEC Standard)	25.1 μ V/28 dB

LW TUNER SECTION

Tuning Range	153 – 281 kHz
Sensitivity (IEC Standard)	31.6 μ V/30 dB

CD SECTION

Frequency Response	5 – 20,000 Hz (\pm 1 dB)
Wow & Flutter (% WRMS)	Below measurable limits
Total Harmonic Distortion	0.008% (at 1 kHz)
Dynamic Range	95 dB (at 1 kHz)
Signal-to-Noise Ratio	105 dB
Channel Separation	85 dB (at 1 kHz)

PICKUP

Wave Length	795 nm
Laser power	CLASS I

GENERAL

Power Requirement	14.4 V DC (11–16 V allowable)
Maximum Power Output	60W x 4 (CDM-9807RB) 45 W x 4 (CDM-9805R/ CDM-9803RM/CDM- 9803RR/CDM-9803R/ CDE-9802RB/CDE-9801R)
Output Voltage	4 V/10k ohms (CDM-9807RB) 2 V/10k ohms (CDM-9805R/ CDM-9803RM/CDM-9803RR/ CDM-9803R/CDE-9802RB/ CDE-9801R)
Bass	\pm 14 dB at 60 Hz
Treble	\pm 14 dB at 10 kHz
Weight	1.5 kg (3 lbs. 5 oz)

CHASSIS SIZE

Width	178 mm (7")
Height	50 mm (2")
Depth	160 mm (6-5/16")

NOSEPIECE SIZE

Width	170 mm (6-3/4")
Height	46 mm (1-13/16")
Depth	20 mm (25/32")

Due to continuous product improvement, specifications and design are subject to change without notice.

CAUTION

**CLASS 1
LASER PRODUCT**

(Bottom side of player)

19-EN

Installation and Connections

Before installing or connecting the unit, please read the following and pages 2 and 3 of this manual thoroughly for proper use.

Warning

MAKE THE CORRECT CONNECTIONS.

Failure to make the proper connections may result in fire or product damage.

USE ONLY IN CARS WITH A 12 VOLT NEGATIVE GROUND.

(Check with your dealer if you are not sure.) Failure to do so may result in fire, etc.

BEFORE WIRING, DISCONNECT THE CABLE FROM THE NEGATIVE BATTERY TERMINAL.

Failure to do so may result in electric shock or injury due to electrical shorts.

DO NOT SPLICE INTO ELECTRICAL CABLES.

Never cut away cable insulation to supply power to other equipment. Doing so will exceed the current carrying capacity of the wire and result in fire or electric shock.

DO NOT DAMAGE PIPE OR WIRING WHEN DRILLING HOLES.

When drilling holes in the chassis for installation, take precautions so as not to contact, damage or obstruct pipes, fuel lines, tanks or electrical wiring. Failure to take such precautions may result in fire.

DO NOT USE BOLTS OR NUTS IN THE BRAKE OR STEERING SYSTEMS TO MAKE GROUND CONNECTIONS.

Bolts or nuts used for the brake or steering systems (or any other safety-related system), or tanks should NEVER be used for installations or ground connections. Using such parts could disable control of the vehicle and cause fire etc.

DO NOT INSTALL IN LOCATIONS WHICH MIGHT HINDER VEHICLE OPERATION, SUCH AS THE STEERING WHEEL OR GEARSHIFT.

Doing so may obstruct forward vision or hamper movement etc. and results in serious accident.

Caution

HAVE THE WIRING AND INSTALLATION DONE BY EXPERTS.

The wiring and installation of this unit requires special technical skill and experience. To ensure safety, always contact the dealer where you purchased this product to have the work done.

USE SPECIFIED ACCESSORY PARTS AND INSTALL THEM SECURELY.

Be sure to use only the specified accessory parts. Use of other than designated parts may damage this unit internally or may not securely install the unit in place. This may cause parts to become loose resulting in hazards or product failure.

ARRANGE THE WIRING SO IT IS NOT CRIMPED OR PINCHED BY A SHARP METAL EDGE.

Route the cables and wiring away from moving parts (like the seat rails) or sharp or pointed edges. This will prevent crimping and damage to the wiring. If wiring passes through a hole in metal, use a rubber grommet to prevent the wire's insulation from being cut by the metal edge of the hole.

DO NOT INSTALL IN LOCATIONS WITH HIGH MOISTURE OR DUST.

Avoid installing the unit in locations with high incidence of moisture or dust. Moisture or dust that penetrates into this unit may result in product failure.

Precautions

- Be sure to disconnect the cable from the (-) battery post before installing your unit. This will reduce any chance of damage to the unit in case of a short-circuit.
- Be sure to connect the colour coded leads according to the diagram. Incorrect connections may cause the unit to malfunction or damage to the vehicle's electrical system.
- When making connections to the vehicle's electrical system, be aware of the factory installed components (e.g. on-board computer). Do not tap into these leads to provide power for this unit. When connecting this unit to the fuse box, make sure the fuse for the intended circuit of the unit has the appropriate amperage. Failure to do so may result in damage to the unit and/or the vehicle. When in doubt, consult your ALPINE dealer.
- This unit uses female RCA-type jacks for connection to other units (e.g. amplifier) having RCA connectors. You may need an adaptor to connect other units. If so, please contact your authorized ALPINE dealer for assistance.
- Be sure to connect the speaker (-) leads to the speaker (-) terminal. Never connect left and right channel speaker cables to each other or to the vehicle body.

IMPORTANT

Please record the serial number of your unit in the space provided below and keep it as a permanent record. The serial number plate is located on the bottom of the unit.

SERIAL NUMBER: _____
INSTALLATION DATE: _____
INSTALLATION TECHNICIAN: _____
PLACE OF PURCHASE: _____

Installation

Caution (CDM-9807RB/CDM-9805R only)

Do not block the unit's fan or heat sink, thus preventing air circulation. If blocked, heat will accumulate inside the unit and may cause a fire.

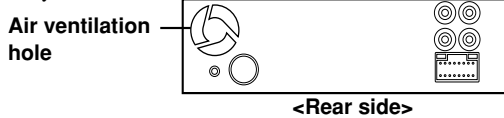

1

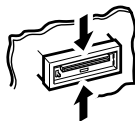
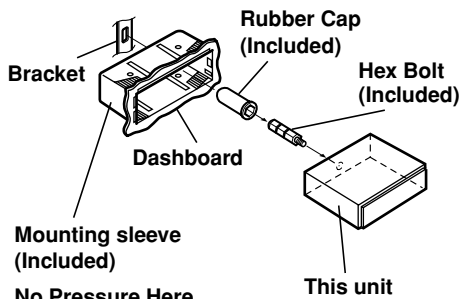

No Pressure Here

Remove the Detachable Front Panel (refer to page 4). Slide mounting sleeve from main unit (see Removal Procedure below). Slide the mounting sleeve into the dashboard.

2

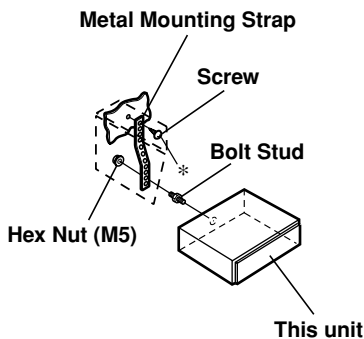

When your vehicle has the Bracket, mount the long hex bolt onto the rear panel of this unit and put the Rubber Cap on the hex bolt. If your vehicle does not have the Mounting Support, reinforce the head unit with the metal mounting strap (not supplied). Connect all the leads of this unit according to details described in the CONNECTIONS section.

NOTE

For the screw *, provide a proper screw to the chassis installing location.

- 3 Slide the unit into the dashboard. When the unit is in place, make sure the locking pins are fully seated in the down position. This can be done by pressing firmly in on the unit while pushing the locking pin down with a small screwdriver. This ensures that the unit is properly locked and will not accidentally come out from the dashboard. Install the Detachable Front Panel.

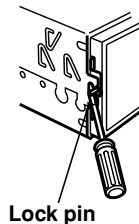

Removal

- 1 Remove the detachable front panel.
- 2 Use a small screwdriver (or similar tool) to push the locking pins to the "up" position (see Fig. 3). As each pin is unlocked, gently pull out on the unit to make sure it does not re-lock before unlocking the second pin.
- 3 Pull the unit out, keeping it unlocked as you do so.

<JAPANESE CAR>

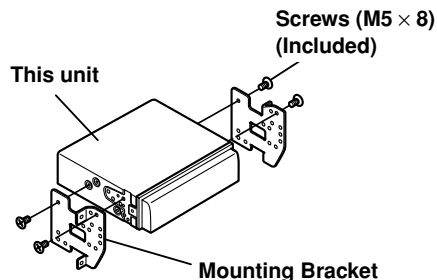
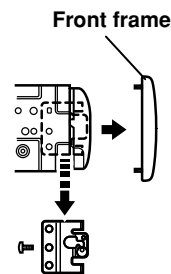

Installation and Connections

Connection

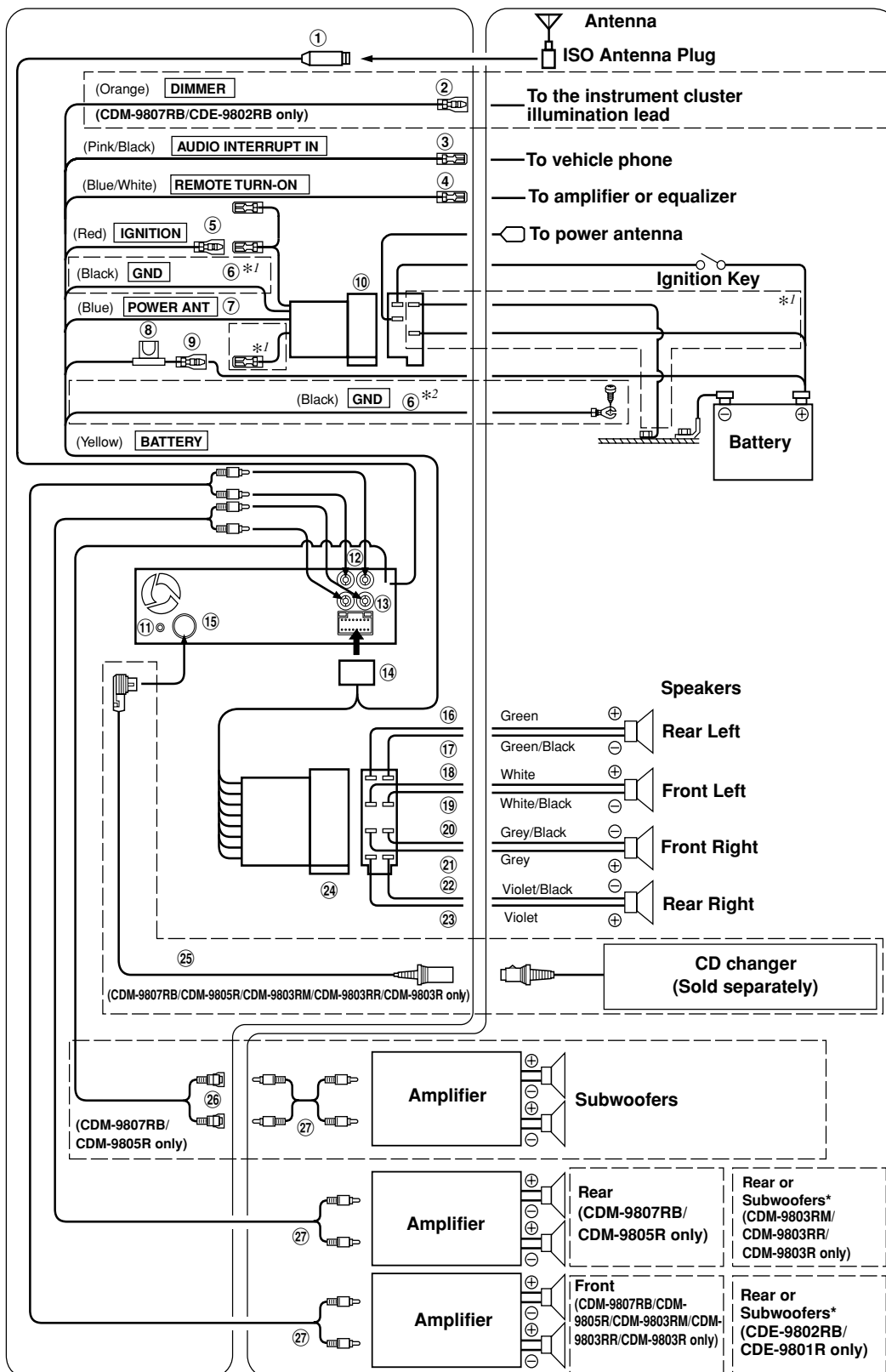

*1 CDM-9805R/CDM-9803RM/CDM-9803RR/CDM-9803R/CDM-9802RB/CDM-9801R only

*2 CDM-9807RB only

- ① Antenna Receptacle
- ② Dimmer Lead (Orange) (CDM-9807RB/CDE-9802RB only)
This lead may be connected to the vehicle's instrument cluster illumination lead. This will enable the vehicle's dimmer control to dim the backlighting of the unit.
- ③ Audio Interrupt In Lead (Pink/Black)
Connect this lead to the Audio Interface output of a cellular phone which provides ground shorting when a call is received.
If a device having the interrupt feature is connected, audio will be automatically muted whenever the interrupt signal is received from the device.
- ④ Remote Turn-On Lead (Blue/White)
Connect this lead to the remote turn-on lead of your amplifier or signal processor.
- ⑤ Switched Power Lead (Ignition) (Red)
Connect this lead to an open terminal on the vehicle's fuse box or another unused power source which provides (+) 12V only when the ignition is turned on or in the accessory position.
- ⑥ Ground Lead (Black)
Connect this lead to a good chassis ground on the vehicle. Make sure the connection is made to bare metal and is securely fastened using the sheet metal screw provided.
- ⑦ Power Antenna Lead (Blue)
Connect this lead to the +B terminal of your power antenna, if applicable.
NOTE
This lead should be used only for controlling the vehicle's power antenna. Do not use this lead to turn on an amplifier or a signal processor, etc.
- ⑧ Fuse Holder
(CDM-9807RB: 20A
CDM-9805R/CDM-9803RM/CDM-9803RR/CDM-9803R/CDE-9802RB/CDE-9801R: 15A)
- ⑨ Battery Lead (Yellow)
Connect this lead to the positive (+) post of the vehicle's battery.
- ⑩ ISO Power Supply Connector
- ⑪ Remote Control Interface Connector
(CDM-9807RB/CDM-9805R/CDM-9803RM/CDM-9803RR/CDM-9803R only)
To remote control interface box.
- ⑫ Front Output RCA Connectors (CDM-9807RB/CDM-9805R/CDM-9803RM/CDM-9803RR/CDM-9803R only)
RED is right and WHITE is left.
- ⑫ Rear/Subwoofer* Output RCA Connectors (CDE-9802RB/CDE-9801R only)
RED is right and WHITE is left.
* When Subwoofer is set to OFF: Output is from Rear speakers.
When Subwoofer is set to ON: Output is from Subwoofer.
- ⑬ Rear Output RCA Connectors (CDM-9807RB/CDM-9805R only)
RED is right and WHITE is left.
- ⑬ Rear/Subwoofer* Output RCA Connectors (CDM-9803RM/CDM-9803RR/CDM-9803R only)
RED is right and WHITE is left.
* When Subwoofer is set to OFF: Output is from Rear speakers.
When Subwoofer is set to ON: Output is from Subwoofer.
- ⑭ Power Supply Connector
- ⑮ DIN Connector (CDM-9807RB/CDM-9805R/CDM-9803RM/CDM-9803RR/CDM-9803R only)
Connect this to the DIN connector on the CD changer.
- ⑯ Left Rear (+) Speaker Output Lead (Green)
- ⑰ Left Rear (-) Speaker Output Lead (Green/Black)
- ⑱ Left Front (+) Speaker Output Lead (White)
- ⑲ Left Front (-) Speaker Output Lead (White/Black)
- ⑳ Right Front (-) Speaker Output Lead (Grey/Black)
- ㉑ Right Front (+) Speaker Output Lead (Grey)
- ㉒ Right Rear (-) Speaker Output Lead (Violet/Black)
- ㉓ Right Rear (+) Speaker Output Lead (Violet)
- ㉔ ISO Connector (Speaker Output)
- ㉕ DIN Extension Cable (Included with CD changer)
NOTE
Older Alpine CD changer came with standard, straight type DIN connectors. In installations where an L-type connector would simplify installation, the Alpine 4910₀₂ Adaptor can be used (sold separately).
- ㉖ Subwoofer Output RCA Connectors (CDM-9807RB/CDM-9805R only)
RED is right and WHITE is left.
- ㉗ RCA Extension Cable (sold separately)

For details on how to set the Subwoofer to ON/OFF, see "Subwoofer On and Off" on page 16.

To prevent external noise from entering the audio system.

- Locate the unit and route the leads at least 10cm away from the car harness.
- Keep the battery power leads as far away from other leads as possible.
- Connect the ground lead securely to a bare metal spot (remove any paint, dirt or grease if necessary) of the car chassis.
- If you add an optional noise suppressor, connect it as far away from the unit as possible. Your Alpine dealer carries various noise suppressors, contact them for further information.
- Your Alpine dealer knows best about noise prevention measures so consult your dealer for further information.

