

FOR CAR USE ONLY/NUR FÜR AUTOMOBIL GEBRAUCH/POUR APPLICATION AUTOMOBILE UNIQUEMENT/
PARA USO EN AUTOMÓVILES/SOLO PER L'UTILIZZO IN AUTOMOBILE/ENDAST FÖR BILBRUK

ALPINE®

RDS MP3/WMA CD Receiver

CDA-9855R

CDA-9853R

MLX MP3



- **OWNER'S MANUAL**
Please read before using this equipment.
- **BEDIENUNGSANLEITUNG**
Lesen Sie diese Bedienungsanleitung bitte vor Gebrauch des Gerätes.
- **MODE D'EMPLOI**
Veuillez lire avant d'utiliser cet appareil.
- **MANUAL DE OPERACIÓN**
Léalo antes de utilizar este equipo.
- **ISTRUZIONI PER L'USO**
Si prega di leggere prima di utilizzare il attrezzatura.
- **ANVÄNDARHANDLEDNING**
Innan du använder utrustningen bör du läsa igenom denna användarhandledning.

ALPINE ELECTRONICS MARKETING, INC.
1-1-8 Nishi Gotanda,
Shinagawa-ku,
Tokyo 141-0031, Japan
Phone 03-5496-8231

ALPINE ELECTRONICS OF AMERICA, INC.
19145 Gramercy Place, Torrance,
California 90501, U.S.A.
Phone 1-800-ALPINE-1 (1-800-257-4631)

ALPINE ELECTRONICS OF CANADA, INC.
777 Supertest Road, Toronto,
Ontario M3J 2M9, Canada
Phone 1-800-ALPINE-1 (1-800-257-4631)

ALPINE ELECTRONICS OF AUSTRALIA PTY. LTD.
161-165 Princes Highway, Hallam
Victoria 3803, Australia
Phone 03-8787-1200

ALPINE ELECTRONICS GmbH
Frankfurter Ring 117,
80807 München, Germany
Phone 089-32 42 640

ALPINE ELECTRONICS OF U.K. LTD.
Alpine House
Fletchamstead Highway, Coventry CV4 9TW, U.K.
Phone 0870-33 33 763

ALPINE ELECTRONICS FRANCE S.A.R.L.
(RCS PONTOISE B 338 101 280)
98, Rue de la Belle Etoile, Z.I. Paris Nord II,
B.P. 50016, 95945 Roissy Charles de Gaulle
Cedex, France
Phone 01-48638989

ALPINE ITALIA S.p.A.
Viale C. Colombo 8, 20090 Trezzano
Sul Naviglio (MI), Italy
Phone 02-484781

ALPINE ELECTRONICS DE ESPAÑA, S.A.
Portal de Gamarra 36, Pabellón, 32
01013 Vitoria (Alava)-APDO 133, Spain
Phone 945-283588

EN

DE

FR

ES

IT

SE

Contents

Operating Instructions



WARNING

WARNING	3
CAUTION	3
PRECAUTIONS	3

About the GlideTouch™ Bar Operation	6
--	----------

Getting Started

Turning Power On and Off	7
Initial System Start-Up	7
Opening and Closing the Movable Display	7
Display Tilt Adjustment	7
Adjusting Volume	7
Detaching and Attaching the Front Panel	8

Radio

Listening to Radio	8
Manual Storing of Station Presets	9
Automatic Memory of Station Presets	9
Tuning to Preset Stations	9
Station Title Search Function	9
Frequency Search Function	9

RDS

Setting RDS Reception Mode and Receiving RDS Stations	10
Recalling Preset RDS Stations	10
Receiving RDS Regional (Local) Stations	10
PI SEEK Setting	11
Receiving Traffic Information	11
PTY (Programme Type) Tuning	11
Receiving Traffic Information While Playing CD or Radio	11
Priority PTY (Programme Type)	12
Displaying Radio Text	12

CD/MP3/WMA

Playback	13
Repeat Play	14
M.I.X. (Random Play)	14
Scanning Programmes	14
Searching from CD Text	15
File/Folder Name Search (concerning MP3/WMA)	15
Quick Search	15
About MP3/WMA	15

Sound Setting

Adjusting Balance (Between Left and Right)/ Fader (Between Front and Rear)/Defeat	17
Equalizer Presets	17
Setting User's EQ mode	17
Adjusting and Storing the Parametric Equalizer Curve	18
Adjusting and Storing the Graphic Equalizer Curve	18
Recalling the Stored Equalizer Curve	19
About the Crossover	19
Adjusting and Storing the Crossover Settings	20
Recalling the Stored Crossover Settings	21
About Time Correction	21
Setting the Time Correction Unit	22
Adjusting and Storing the Time Correction	22
Recalling the Stored Time Correction Settings	23
Setting the MX Mode	23

Other Functions

Displaying the Title/Text	24
Titling Discs/Stations	25
Erasing Disc Title/Station Title	26
Blackout Mode On and Off (CDA-9855R only)	26
Setting Amplifier Link	26

Displaying the External Amplifier Information	27
Setting the Multicolour Illumination	27
Changing the Lighting Colour of All the Buttons	27

i-Personalize™ Operation

About i-Personalize™	28
Data Downloading	28

SETUP

General Setting

Playing MP3/WMA Data (PLAY MODE)	29
Sound (Beep) Guide Function	29
Turning Mute Mode On/Off	30
Setting the External Digital Input	30
Setting Tone Defeat for External Devices	30
Setting the AUX Mode (V-Link)	30
Connecting to an External Amplifier	30
Setting the Steering Position	30

Tuner Setting

Adjusting Source Signal Levels	30
Switching the Tuner Mode	30

Audio Setting

Subwoofer On and Off	31
Setting the Subwoofer Output	31
Setting the Subwoofer System	31
Setting the Response Slope for the High Range Speaker (TW SETUP)	31
Connecting an Optical Digital Compatible Audio Processor and an Ai-NET Non-Compatible DVD Player	31

Display Setting

Dimmer Control	31
Setting the Display Dimmer	31
Scroll Type Setting	31
Scroll Setting	32
Adjusting Display Contrast (CDA-9853R only)	32
Switching the Character Font (CDA-9855R only)	32

Setting the Temperature Display for the External Amplifier	32
Setting the Display of the Audio Level Indicator (CDA-9853R only)	32
Switching the Animation Display Type (CDA-9855R only)	32

Demo Setting

Demonstration	32
---------------------	----

iPod™ Operation (Optional)

Playback	32
Searching for a desired Song	32
Searching by Playlist	33
Searching by artist name	33
Searching by album name	33
Quick Search	33
Random Play Shuffle (M.I.X.)	34
Repeat Play	34
Displaying the Text	34

Changer (Optional)

Controlling CD Changer (Optional)	35
Playing MP3 Files with the CD Changer (Optional)	35
Multi-Changer Selection (Optional)	35

Remote Control

Controls on Remote Control (CDA-9855R only)	36
Operating the Audio Processor (CDA-9855R only)	36
Battery Replacement (CDA-9855R only)	37

Information

In Case of Difficulty	37
Specifications	39

Installation and Connections

Warning	40
Caution	40
Precautions	40
Installation	41
Connections	42

Operating Instructions

WARNING

WARNING

This symbol means important instructions. Failure to heed them can result in serious injury or death.

DO NOT OPERATE ANY FUNCTION THAT TAKES YOUR ATTENTION AWAY FROM SAFELY DRIVING YOUR VEHICLE.

Any function that requires your prolonged attention should only be performed after coming to a complete stop. Always stop the vehicle in a safe location before performing these functions. Failure to do so may result in an accident.

KEEP THE VOLUME AT A LEVEL WHERE YOU CAN STILL HEAR OUTSIDE NOISE WHILE DRIVING.

Failure to do so may result in an accident.

DO NOT DISASSEMBLE OR ALTER.

Doing so may result in an accident, fire or electric shock.

USE ONLY IN CARS WITH A 12 VOLT NEGATIVE GROUND.

(Check with your dealer if you are not sure.) Failure to do so may result in fire, etc.

KEEP SMALL OBJECTS SUCH AS BATTERIES OUT OF THE REACH OF CHILDREN.

Swallowing them may result in serious injury. If swallowed, consult a physician immediately.

USE THE CORRECT AMPERE RATING WHEN REPLACING FUSES.

Failure to do so may result in fire or electric shock.

DO NOT BLOCK VENTS OR RADIATOR PANELS.

Doing so may cause heat to build up inside and may result in fire.

USE THIS PRODUCT FOR MOBILE 12V APPLICATIONS.

Use for other than its designed application may result in fire, electric shock or other injury.

DO NOT PLACE HANDS, FINGERS OR FOREIGN OBJECTS IN INSERTION SLOTS OR GAPS.

Doing so may result in personal injury or damage to the product.

CAUTION

This symbol means important instructions. Failure to heed them can result in injury or material property damage.

HALT USE IMMEDIATELY IF A PROBLEM APPEARS.

Failure to do so may cause personal injury or damage to the product. Return it to your authorized Alpine dealer or the nearest Alpine Service Centre for repairing.

DO NOT MIX NEW BATTERIES WITH OLD BATTERIES. INSERT WITH THE CORRECT BATTERY POLARITY.

When inserting the batteries, be sure to observe proper polarity (+ and -) as instructed. Rupture or chemical leakage from the battery may cause fire or personal injury.

KEEP FINGERS AWAY WHILE THE MOTORIZED FRONT PANEL OR MOVING MONITOR IS IN MOTION.

Failure to do so may result in personal injury or damage to the product.

PRECAUTIONS

Product Cleaning

Use a soft dry cloth for periodic cleaning of the product. For more severe stains, please dampen the cloth with water only. Anything else has the chance of dissolving the paint or damaging the plastic.

Temperature

Be sure the temperature inside the vehicle is between +60°C (+140°F) and -10°C (+14°F) before turning your unit on.

Moisture Condensation

You may notice the CD playback sound wavering due to condensation. If this happens, remove the disc from the player and wait about an hour for the moisture to evaporate.

Damaged Disc

Do not attempt to play cracked, warped, or damaged discs. Playing a bad disc could severely damage the playback mechanism.

Maintenance

If you have problems, do not attempt to repair the unit yourself. Return it to your Alpine dealer or the nearest Alpine Service Station for servicing.

PRECAUTIONS

Never Attempt the Following

Do not grip or pull out the disc while it is being pulled back into the player by the automatic reloading mechanism.

Do not attempt to insert a disc into the unit when the unit power is off.

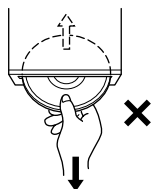

Inserting Discs

Your player accepts only one disc at a time for playback. Do not attempt to load more than one disc.

Make sure the label side is facing up when you insert the disc.

Your player will automatically eject any disc that is inserted incorrectly. If the player continues to eject a correctly inserted disc, push the RESET switch with a pointed object such as a ballpoint pen.

Playing a disc while driving on a very bumpy road may result in skips, but this will not scratch the disc or damage the player.

New Discs

As a protective measure to prevent the CD from jamming, the CD player will automatically eject discs with irregular surfaces or inserted incorrectly. When a new disc is inserted into the player and ejected after initial loading, using your finger, feel around the inside of the centre hole and outside edge of the disc. If you feel any small bumps or irregularities, this could inhibit proper loading of the disc. To remove the bumps, rub the inside edge of the hole and outside edge of the disc with a ballpoint pen or other such instrument, then insert the disc again.

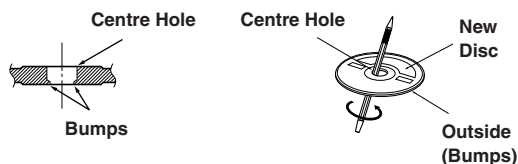

Irregular Shaped Discs

Be sure to use round shape discs only for this unit and never use any special shape discs.

Use of special shape discs may cause damage to the mechanism.



Installation Location

Make sure the CDA-9855R/CDA-9853R will not be installed in a location subjected to:

- Direct sun and heat
- High humidity and water
- Excessive dust
- Excessive vibrations

Correct Handling

Do not drop the disc while handling. Hold the disc so you will not leave fingerprints on the surface. Do not affix tape, paper, or gummed labels to the disc. Do not write on the disc.

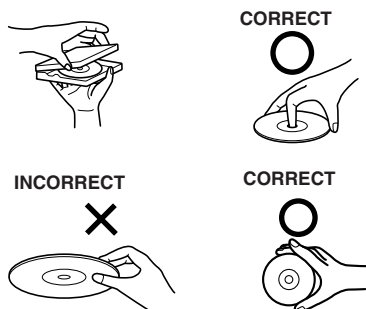

Disc Cleaning

Fingerprints, dust, or soil on the surface of the disc could cause the CD player to skip. For routine cleaning, wipe the playing surface with a clean, soft cloth from the centre of the disc to the outer edge. If the surface is heavily soiled, dampen a clean, soft cloth in a solution of mild neutral detergent before cleaning the disc.



Disc Accessories

There are various accessories available on the market for protecting the disc surface and improving sound quality. However, most of them will influence the thickness and/or diameter of the disc. Using such accessories can cause the disc to be out of standard specifications and may create operational problems. We recommend not using these accessories on discs played in Alpine CD players.

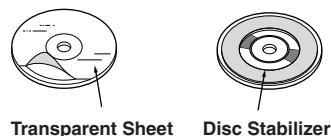

On handling Compact Discs (CD/CD-R/CD-RW)

- Do not touch the surface.
- Do not expose the disc to direct sunlight.
- Do not affix stickers or labels.
- Clean the disc when it is dusty.
- Make sure that there are no bumps around the disc.
- Do not use commercially available disc accessories.

Do not leave the disc in the car or the unit for a long time. Never expose the disc to direct sunlight. Heat and humidity may damage the CD and you may not be able to play it again.

To customers using CD-R/CD-RW

- If a CD-R/CD-RW cannot be played back, make sure the last recording session was closed (finalized).
- Finalize the CD-R/CD-RW if necessary, and attempt playback again.

About media that can be played.

Use only compact discs with the label side showing the CD logo marks below.



If you use unspecified compact discs, correct performance cannot be guaranteed.

You can play CD-Rs (CD-Recordable)/CD-RWs (CD-ReWritable) which have been recorded only on audio devices.

You can also play CD-Rs/CD-RWs containing MP3/WMA formatted audio files.

- Some of the following CDs may not play on this unit:
Flawed CDs, CDs with fingerprints, CDs exposed to extreme temperatures or sunlight (e.g., left in the car or this unit), CDs recorded under unstable conditions, CDs on which a recording failed or a re-recording was attempted, copy-protected CDs which do not conform to the audio CD industry standard.
- Use discs with MP3/WMA files written in a format compatible with this unit. For details, see pages 15-16.

Windows Media and the Windows logo are trademarks, or registered trademarks of Microsoft Corporation in the United States and /or other countries.

Apple, the Apple logo and iPod are trademarks of Apple Computer, Inc., registered in the U.S. and other countries.

About the GlideTouch™ Bar Operation

1 Touch or press the desired position on the GlideTouch bar.

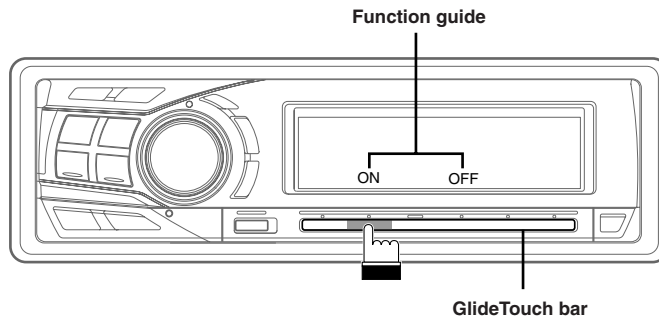

Press any one of the 6 positions on the **GlideTouch bar** to which a function has been assigned in the guide display. For example, to select ON, press the **GlideTouch bar** directly below where ON is indicated in the guide display. The manual expresses this as follows: "Change the setting by pressing the **GlideTouch bar** below either the ON or OFF function indicators."

2 Move your finger on the GlideTouch bar to the left or right.

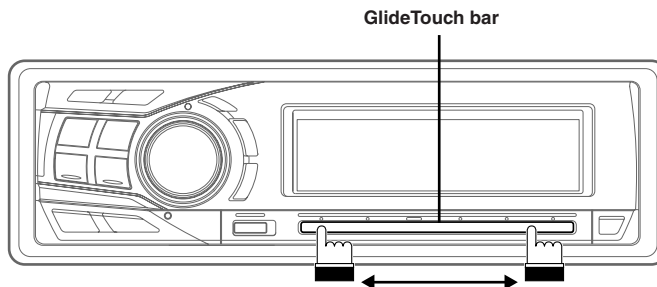

Place your finger on the **GlideTouch bar** and slide it gently to the left or right. Items or lists in the display will change as you move your finger across the **GlideTouch bar**.

To select items on the following page, scroll the page as follows:

- Place and hold your finger on either the side of the **GlideTouch bar** to which the following page will be found for at least 3 seconds.
When scrolling the page to the left, place and hold your finger on the left side of the **GlideTouch bar**.
When scrolling the page to the right, place and hold your finger on the right side of the **GlideTouch bar**.
- Move your finger quickly on the **GlideTouch bar** toward the side that the page is scrolled.

Getting Started

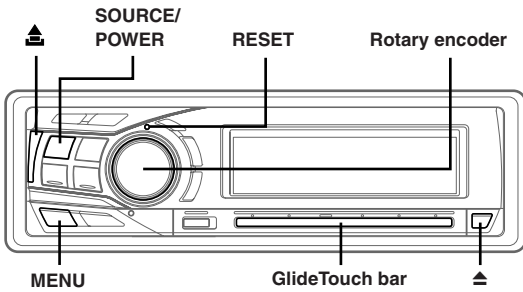

Turning Power On and Off

Press **SOURCE/POWER** to turn on the unit.

- The unit can be turned on by pressing any other button except eject ▲.

Press and hold **SOURCE/POWER** for at least 2 seconds to turn off the unit.

- The first time power is turned on, the volume will start from level 12.

Initial System Start-Up

Be sure to press the RESET switch when using the unit for the first time, after installing the CD changer, after changing the car battery, etc.

- 1 Turn off the unit power.
- 2 Press **RESET** with a ballpoint pen or similar pointed object.

Opening and Closing the Movable Display

Press ▲.

The movable display will open.

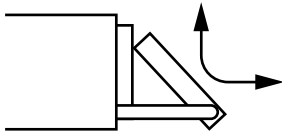

To close the movable display, press ▲ again.

The movable display will close.

- Do not apply shock to the movable display when it is open as it may result in malfunction of the unit.
- The display may be dim during low temperatures and immediately after turning on the power. The brightness will return to normal as time elapses.
- The display will stop at the set tilt angle when closing.

Caution

Keep hands (or any other object) away from the display while it is opening or closing to avoid damage or injury. The back of the movable display will get very warm under normal operating conditions. This is not a malfunction. Do not touch.

Display Tilt Adjustment

The movable display may be adjusted to 3 different tilt angles depending upon user preference.

- 1 Press **MENU**.
- 2 Select **TILT (TILT ADJUST)** by sliding your finger on the **GlideTouch bar** to the left or right. Press the **GlideTouch bar** under **TILT (TILT ADJUST)**.
- 3 Touch the **GlideTouch bar** under **UP** or **DOWN** to adjust the display tilt angle.

- Selecting **RETURN** will return to the previous screen.

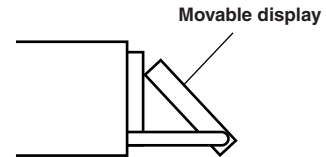

- 4 After setting, press and hold **MENU** for at least 2 seconds to return to normal mode.

- The adjusted tilt angle of the display is stored in memory. There is no need to re-adjust the tilt angle when the power is turned back on.
- If **MENU** is pressed while adjusting or setting items in the **MENU** mode, the unit will return to the previous selection screen.
- By pressing the **GlideTouch bar** under **RETURN** in the **MENU** mode, the unit returns to the normal mode.

Caution

Keep hands (or any other object) away from the display while it is opening or closing to avoid damage or injury. The back of the movable display will get very warm under normal operating conditions. This is not a malfunction. Do not touch.

Adjusting Volume

Turn the **Rotary encoder** until the desired sound is obtained.

Detaching and Attaching the Front Panel

Detaching

- 1 Turn off the unit power.
- 2 Press  (Release) at the upper left side until the front panel pops out.
- 3 Grasp the left side of the front panel and pull it out.

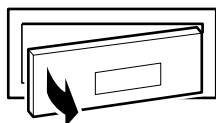

- The front panel may become hot in normal usage (especially the connector terminals on the back of the front panel.) This is not a malfunction.
- To protect the front panel, place it in the supplied carrying case.

Attaching

- 1 Insert the right side of the front panel into the main unit. Align the groove on the front panel with the projections on the main unit.
- 2 Push the left side of the front panel until it locks firmly into the main unit.

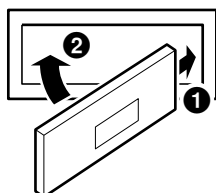

- Before attaching the front panel, make sure that there is no dirt or dust on the connector terminals and no foreign object between the front panel and the main unit.
- Attach the front panel carefully, holding the sides of the front panel to avoid pushing buttons by mistake.

Radio

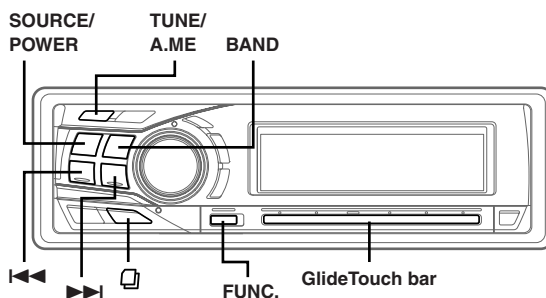

Listening to Radio

- 1 Press **SOURCE/POWER** until a radio frequency appears in the display.
- 2 Press **BAND** repeatedly until the desired radio band is displayed.
FM1 → FM2 → FM3 → MW → LW → FM1
- 3 Press **TUNE/A.ME** to select the tuning mode.

CDA-9855R:

DX (Distance mode) → LOCAL (Local mode) →
MANUAL (Manual mode) → DX

CDA-9853R:

DX SEEK (Distance mode) → SEEK (Local mode) →
OFF (Manual mode) → DX SEEK

- The initial mode is Distance mode.

Distance mode:

Both strong and weak stations will be automatically tuned in (Automatic Seek Tuning).

Local mode:

Only strong stations will be automatically tuned in (Automatic Seek Tuning).

Manual mode:

The frequency is manually tuned in steps (Manual tuning).

- 4 Press **◀◀** or **▶▶** to tune in the desired station.
Holding down **◀◀** or **▶▶** will change the frequency continuously.
- The ST indicator appears on the display when a stereo FM station is tuned in.
 - With the CDA-9855R, you can tune the radio with the **GlideTouch bar**. Press **FUNC.** to select the source operation mode. Press the **GlideTouch bar** under the desired function shown in the function guide display.

Manual Storing of Station Presets

- 1 Select the radio band and tune in a desired radio station you wish to store in the preset memory.**
- 2 Press **FUNC.** to activate the preset mode.**

Source select mode → Audio function mode → Preset mode
→ Source operation mode* → Source select mode

* CDA-9855R only
- 3 Select any one of the preset numbers (1 through 6) by sliding your finger on the **GlideTouch bar** to the left or right. Press and hold the **GlideTouch bar** for at least 2 seconds under the selected preset number.**

The selected station is stored.
The display shows the preset no. and station frequency memorized.

 - A total of 30 stations can be stored in the preset memory (6 stations for each band; FM1, FM2, FM3, MW and LW).
 - If you store a station in a preset memory which already has a station, the current station will be cleared and replaced with the new station.

Automatic Memory of Station Presets

- 1 Press **BAND** repeatedly until the desired radio band is displayed.**
- 2 Press and hold **TUNE/A.ME** for at least 2 seconds.**

The frequency on the display continues to change while the automatic memory is in progress. The tuner will automatically seek and store 6 strong stations in the selected band. They will be stored into buttons 1 to 6 in order of signal strength.
When the automatic memory has been completed, the tuner goes to the station stored in preset location no. 1.

 - If no stations are stored, the tuner will return to the original station you were listening to before the auto memory procedure began.

Tuning to Preset Stations

- 1 Press **BAND** repeatedly until the desired band is displayed.**
- 2 Press **FUNC.** to activate the preset mode.**

Source select mode → Audio function mode → Preset mode
→ Source operation mode* → Source select mode

* CDA-9855R only
- 3 Select any one of the preset numbers (1 through 6) by sliding your finger to the left or right on the **GlideTouch bar**. Press the **GlideTouch bar** under the selected preset number.**

The display shows the band, preset number and frequency of the station selected.

Station Title Search Function

If the title of a radio station is entered, you can search for that radio station by its title while listening to the currently received radio station.

- 1 Press **□** in Radio mode to switch to Title Search mode.**

This will set the search mode.
- 2 Within 10 seconds, select the desired title by sliding your finger to the left or right on the **GlideTouch bar**. Press the **GlideTouch bar** under the selected title.**

The radio station of the selected title is received.

 - Title Search mode is cancelled by pressing and holding **□** for at least 2 seconds.
 - If either side of the **GlideTouch bar** is touched and held, the radio stations are scrolled continuously.
 - You can speed up your search by moving your finger quickly on the **GlideTouch bar** to skip radio stations.
 - If a station has no title, "NO TITLE" is displayed for 2 seconds.
 - Any radio station can be searched by the Station Title Search function. The station titles are displayed in the order they were input.

Frequency Search Function

You can search for a radio station by its frequency.

- 1 Press and hold **□** for at least 2 seconds in Radio mode to activate Frequency Search mode.**
- 2 Within 10 seconds, select the desired frequency by sliding your finger to the left or right on the **GlideTouch bar**. Press the **GlideTouch bar** under the desired frequency.**

The radio station on the frequency selected is received.

 - Search mode in Frequency Search mode is cancelled by pressing and holding **□** for at least 2 seconds.
 - If either side of the **GlideTouch bar** is touched and held, the frequencies are scrolled continuously.
 - You can speed up your search by moving your finger quickly on the **GlideTouch bar** to skip frequencies.

RDS

Recalling Preset RDS Stations

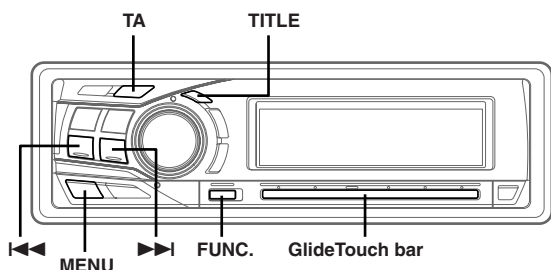

Setting RDS Reception Mode and Receiving RDS Stations

The RDS (Radio Data System) is a radio information system using the 57 kHz subcarrier of regular FM broadcast. The RDS allows you to receive a variety of information such as traffic information, station names, and to automatically re-tune to a stronger transmitter that is broadcasting the same programme.

1 Press **FUNC.** to activate the audio function mode.

Source select mode → Audio function mode → Preset mode
→ Source operation mode* → Source select mode

* CDA-9855R only

2 Select AF mode by sliding your finger on the **GlideTouch bar** to the left or right. Press the **GlideTouch bar** under the AF mode to active the RDS mode.

3 Press **◀◀** or **▶▶** to tune in the desired RDS station.

4 To deactivate the RDS mode, press **FUNC.**, or activate the audio function mode by touching the **GlideTouch bar**.

5 Select the AF mode by sliding your finger on the **GlideTouch bar** to the left or right. Press the **GlideTouch bar** under the AF mode.

- When the unit receives the **PTY31** (Emergency Broadcast) signal, the unit will show "ALARM" in the display automatically.

The RDS digital data includes the following:

PI	Programme Identification
PS	Programme Service Name
AF	List of Alternative Frequencies
TP	Traffic Programme
TA	Traffic Announcement
PTY	Programme Type
EON	Enhanced Other Networks

1 Press **FUNC.** to activate the audio function mode.

Source select mode → Audio function mode → Preset mode
→ Source operation mode* → Source select mode

* CDA-9855R only

2 Select AF mode by sliding your finger on the **GlideTouch bar** to the left or right. Press the **GlideTouch bar** under the AF mode to active the RDS mode.

3 Press **FUNC.** to activate the preset mode.

4 Select any one of the preset numbers (1 through 6) by sliding your finger to the left or right on the **GlideTouch bar**. Press the **GlideTouch bar** under the selected preset number.

If the preset station's signal is weak, the unit automatically searches and tunes to a stronger station in the AF (Alternative Frequencies) list.

5 If the preset station and the stations in the AF list cannot be received:

When the PI SEEK setting is on (refer to "PI SEEK Setting" page 11), the unit searches again for a station in the PI (Programme Identification) list.

If there are still no stations receivable in the area, the unit displays the frequency of the preset station and the preset no. disappears.

If the signal level of the Regional (Local) station being tuned becomes too weak to receive, press the same preset button to tune in a Regional station in other district.

- For presetting the RDS stations, refer to the Radio Operation section. The RDS stations can be preset in the FM1, FM2 and FM3 bands only.

Receiving RDS Regional (Local) Stations

1 Press **MENU**.

2 Select **SETUP** by sliding your finger on the **GlideTouch bar** to the left or right. Press the **GlideTouch bar** under **SETUP**.

The main SETUP menu is displayed.

3 Select **TUNER** by sliding your finger on the **GlideTouch bar** to the left or right. Press the **GlideTouch bar** under **TUNER**.

The TUNER SETUP menu is displayed.

4 Select **RDS REGIONAL** by sliding your finger on the **GlideTouch bar** to the left or right. Press the **GlideTouch bar** under **RDS REGIONAL**.

5 Press the **GlideTouch bar** under **ON** or **OFF** in the **Function Guide** display.

In the RDS REGIONAL OFF mode, the unit automatically keeps receiving the related local RDS station.

6 Press and hold **MENU** for at least 2 seconds to return to normal mode.

- If **MENU** is pressed while adjusting or setting items in the **MENU** mode, the unit will return to the previous selection screen.
- By pressing the **GlideTouch bar** under **RETURN** in the **MENU** mode, the unit returns to the normal mode.

PI SEEK Setting

- 1 Press **MENU**.
 - 2 Select **SETUP** by sliding your finger on the **GlideTouch bar** to the left or right. Press the **GlideTouch bar** under **SETUP**.
The main SETUP menu is displayed.
 - 3 Select **TUNER** by sliding your finger on the **GlideTouch bar** to the left or right. Press the **GlideTouch bar** under **TUNER**.
The TUNER SETUP menu is displayed.
 - 4 Select **PI SEEK** by sliding your finger on the **GlideTouch bar** to the left or right. Press the **GlideTouch bar** under **PI SEEK**.
 - 5 Press the **GlideTouch bar** under **ON** or **OFF** in the **Function Guide** display.
 - 6 Press and hold **MENU** for at least 2 seconds to return to normal mode.
- If **MENU** is pressed while adjusting or setting items in the **MENU** mode, the unit will return to the previous selection screen.
 - By pressing the **GlideTouch bar** under **RETURN** in the **MENU** mode, the unit returns to the normal mode.

Receiving Traffic Information

- 1 Press **TA** so that the “**TA**” indicator lights up.
- 2 Press **◀◀** or **▶▶** to select your desired traffic information station.

When a traffic information station is tuned in, the “**TP**” indicator lights up.

Traffic information is heard only when it is being broadcast. If traffic information is not being broadcast, the unit is set in the standby mode. When a traffic information broadcast begins, the unit automatically receives it and the display shows “**TRF-INFO**.”

When the traffic information broadcast is over, the unit will automatically set in the standby mode.

- If the traffic information broadcast signal falls below a certain level, the unit remains in the receiving mode for over 1 minute. If the signal remains below a certain level for over 1 minute, the “**TA**” indicator blinks.
- If you do not want to listen to the traffic information being received, lightly press **TA** to skip that traffic information message. The **TA** mode will remain in the **ON** position to receive the next traffic information message.
- If the volume level is changed while receiving traffic information, the changed volume level will be memorized. When traffic information is received next time, the volume level will be automatically adjusted to the level memorized.
- In the **TA** mode, the **SEEK** tuning selects only the **TP** stations.

PTY (Programme Type) Tuning

- 1 Press **FUNC.** to activate the audio function mode.

Source select mode → Audio function mode → Preset mode
→ Source operation mode* → Source select mode

* *CDA-9855R only*

- 2 Select **PTY** by sliding your finger on the **GlideTouch bar** to the left or right. Press the **GlideTouch bar** under the **PTY**.
The Programme Type of the station being currently received will be displayed for 10 seconds.
If there is no receivable **PTY** broadcast, “**NO PTY**” will be displayed for 10 seconds.
If no **RDS** station can be received, the display shows “**NO PTY**.”

- If no operation is performed within 10 seconds after activating the **PTY** mode, the **PTY** mode will be automatically cancelled.

- 3 Press **◀◀** and **▶▶** within 10 seconds after activating the **PTY** mode to choose the desired programme type while the **PTY (programme type)** is being displayed.

Each press scrolls the programme type by one.

--- LIGHT M ↔ CLASSICS ↔ OTHER M ---

- 4 Within 10 seconds, select the **PTY** mode by sliding your finger on the **GlideTouch bar** to the left or right. Press the **GlideTouch bar** under the **PTY**.
The chosen programme type display blinks during searching and lights when a station is found.

If no **PTY** station is found, “**NO PTY**” will be displayed for 10 seconds.

Receiving Traffic Information While Playing CD or Radio

- 1 Press **TA** so that the “**TA**” indicator lights up.
- 2 Press **◀◀** and **▶▶** to select a traffic information station if necessary.

When a traffic information broadcast starts, the unit automatically mutes the **CD** player/changer or the regular **FM** broadcast.

When the traffic information broadcast finishes, the unit automatically returns to the original source play before the traffic information broadcast began.

When traffic information stations cannot be received:

In the tuner mode:

When the **TP** signal can no longer be received for over 1 minute, the “**TA**” indicator blinks.

In the **CD** mode:

When the **TP** signal can no longer be received, the traffic information station of another frequency will be selected automatically.

- The receiver is equipped with the **EON (Enhanced Other Networks)** function in order to keep track of additional alternate frequencies to the **AF** list. The “**EON**” indicator lights up while an **RDS EON** station is being received. If the station being received does not broadcast the traffic information, the receiver automatically tunes in the related station that broadcasts the traffic information when it occurs.

- 3 Press **TA** to deactivate the **Traffic Information mode**.

The “**TA**” indicator goes out.

Priority PTY (Programme Type)

This function allows presetting of a programme type such as music category, news, etc. You can listen to a programme in the preset programme type as the unit automatically gives priority to the preset programme type when it begins broadcasting, and interrupts the programme you are currently listening. This feature is functional when your unit is set to a mode other than the LW and MW.

1 Press **FUNC.** to activate the audio function mode.

Source select mode → Audio function mode → Preset mode
→ Source operation mode* → Source select mode

* CDA-9855R only

2 Select **P. PTY** by sliding your finger on the **GlideTouch bar** to the left or right. Press the **GlideTouch bar** under **P.PTY**.

The initial setting is NEWS.

- If no operation is performed within 10 seconds after activating the **PRIORITY PTY** mode, the **PRIORITY PTY** mode will be automatically cancelled.

3 Press **◀◀** or **▶▶** within 10 seconds while **NEWS** is being displayed to choose a desired programme type.

4 Within 10 seconds, select **P. PTY** mode by sliding your finger on the **GlideTouch bar** to the left or right. Press the **GlideTouch bar** under **P.PTY**.

The **PRIORITY PTY** mode will activate.

To change the programme category, perform the steps 1 to 3. To disable the **PRIORITY PTY** mode, press and hold **P.PTY** on the **GlideTouch bar** for at least 2 seconds.

- In the **PRIORITY PTY** function, unlike in the **TA** function, the volume does not increase during operation.

Displaying Radio Text

Text messages from a radio station can be displayed.

Press **TITLE** while receiving **FM** in the radio mode to select the **Radio Text** display.

The display will change every time the button is pressed.

CDA-9855R

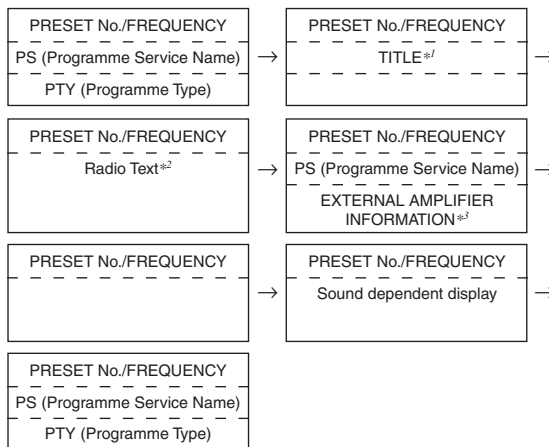

CDA-9853R

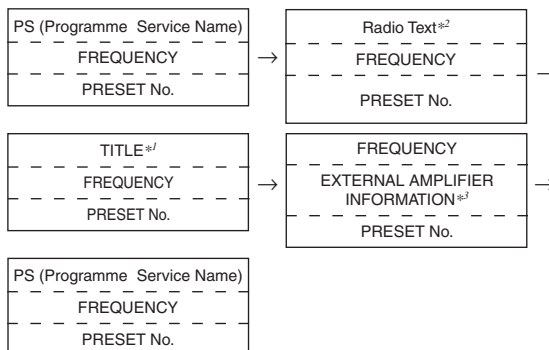

The display shows "WAITING" for a few seconds, then starts scrolling the text message.

*1 **TITLE** can be input or erased.

*2 If there is no receivable text message or the unit cannot receive a text message properly, the display shows "NO TEXT"

*3 Only when an external Amplifier Link compatible amplifier is connected. For details, refer to "Displaying the External Amplifier Information" (page 27).

CD/MP3/WMA

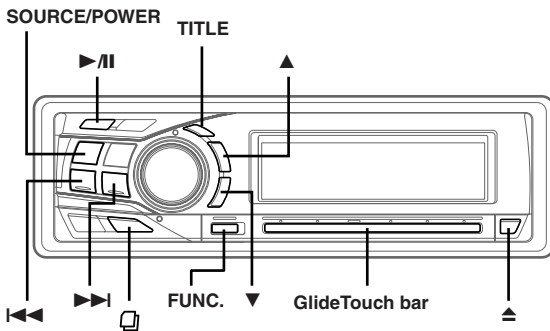

- A WMA format file that is protected by DRM (Digital Rights Management) cannot be played back on this unit.
- “MP3” is displayed during MP3 playback (CDA-9853R only).
- “WMA” is displayed during WMA playback (CDA-9853R only).
- The track display for MP3/WMA data playback is the file numbers recorded on the disc.
- If the HDA-5460 model is connected to the unit, some operations (for example changing the source, selecting the file by holding buttons up or down, etc.), can be carried out on this unit.
- With the CDA-9855R, you can return to the beginning of the current track, fast forward/fast reverse and playback/pause using the **GlideTouch bar**. Press **FUNC.** to select the source operation mode. Press the **GlideTouch bar** under the desired function shown in the function guide display.

MP3/WMA Play Display

The folder number, file number, sampling rate, and bit rate will be displayed as described below.

CDA-9855R

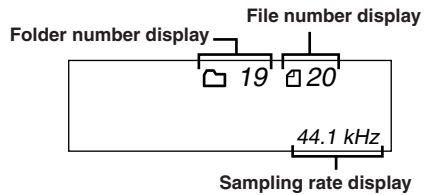

The sampling rate and the bit rate (frame display) are alternately displayed.*

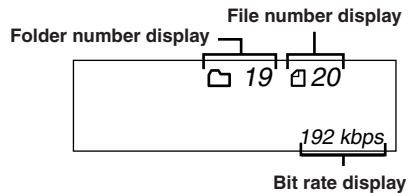

CDA-9853R

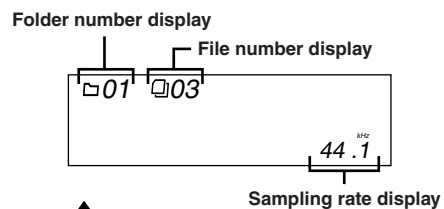

The sampling rate and the bit rate (frame display) are alternately displayed.*

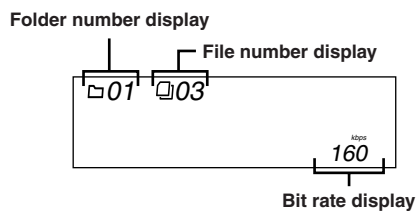

Playback

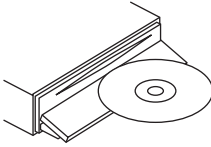
- 1 Press **▲**.
The movable display will open.
 - 2 Insert a disc with the label side facing up.
The disc will be pulled into the unit automatically.
- 
- The movable display will close and playback will begin. When a disc is already inserted, press **SOURCE/POWER** to switch to the CD mode.
- The mode will change every time the button is pressed.
CD → TUNER → CD CHANGER* → CD
- * Only when the CD changer is connected
- 3 While playing back MP3/WMA, press **▲** or **▼** to select the desired folder.
Pressing and holding **▲** or **▼** will change folders continuously.
 - 4 Press **◀◀** or **▶▶** to select the desired track (file).
Returning to the beginning of the current track (file):
Press **◀◀**.
Fast backward :
Press and hold **◀◀**.
Advancing to the beginning of the next track (file) :
Press **▶▶**.
Fast forward :
Press and hold **▶▶**.
 - 5 To pause playback, press **▶/||**.
Pressing **▶/||** again will resume playback.
 - 6 To eject the disc, press **▲**.

- Do not remove a CD during its eject cycle. Do not load more than one disc at a time. A malfunction may result from doing either.
- If the CD does not eject, press and hold **▲** for at least 2 seconds with the movable display open.
- The CD-player can play discs containing audio data, MP3 data and WMA data.

• Press **TITLE** to switch the display. Please see “Displaying the Title/Text” (page 24) for information about display switching.

* The recording sampling rate and bit rate of the MP3/WMA file are displayed. A WMA file of variable bit rate displays the average bit rate.

Repeat Play

1 Press **FUNC.** to activate the audio function mode.

Source select mode → Audio function mode → Source operation mode* → Source select mode

* CDA-9855R only

2 Press the **GlideTouch** bar under **RPT** to select the **RPT mode**.

The track (file) will be played back repeatedly.

CD mode :

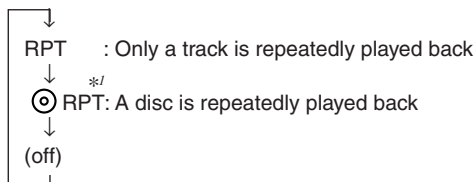

*1 When a CD changer is connected.

- If REPEAT is set to ON during M.I.X. play in CD changer mode, M.I.X. will apply to the current disc only.

MP3/WMA mode :

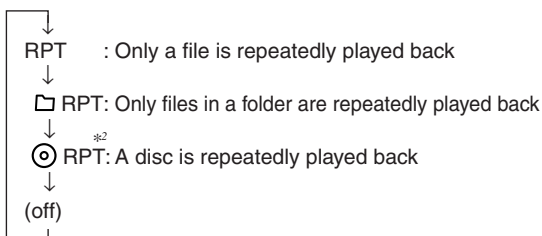

*2 When an MP3 compatible CD changer is connected.

The RPT mode is cancelled if off is selected.

- The function mode you previously recalled can be recalled again if the **GlideTouch** bar is touched.
- If no operation is performed for 10 seconds, the audio function mode turns off.

M.I.X. (Random Play)

1 Press **FUNC.** to activate the audio function mode.

Source select mode → Audio function mode → Source operation mode* → Source select mode

* CDA-9855R only

2 Press the **GlideTouch** bar under **MIX** to select the **Random Play mode**.

The tracks (files) will be played back in random sequence.

CD mode :

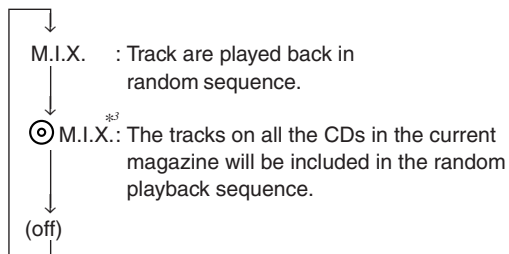

*3 When a CD changer equipped with the All M.I.X. function is connected.

- If M.I.X. is set to ON during ⊙ RPT (REPEAT ALL) play in CD changer mode, M.I.X. will apply to the current disc only.

MP3/WMA mode :

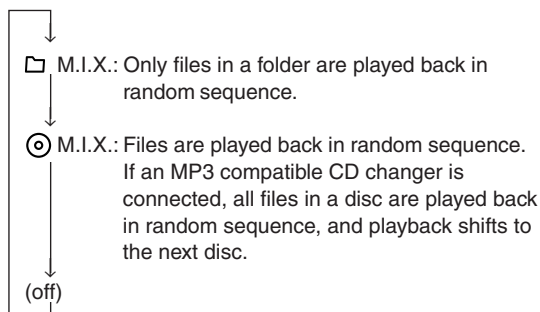

The Random Play mode is cancelled if off is selected.

- The function mode you previously recalled can be recalled again if the **GlideTouch** bar is touched.
- If no operation is performed for 10 seconds, the audio function mode turns off.

Scanning Programmes

1 Press **FUNC.** to activate the audio function mode.

Source select mode → Audio function mode → Source operation mode* → Source select mode

* CDA-9855R only

2 Press the **GlideTouch** bar under **SCAN** to select the **Scan mode**.



The first 10 seconds of each of track (file) will be played back in succession.

3 If the desired song is found, perform steps 1 and 2 to stop scanning.

- The function mode you previously recalled can be recalled again if the **GlideTouch** bar is touched.
- If no operation is performed for 10 seconds, the audio function mode turns off.

Searching from CD Text

Tracks can be searched and played using the CD text on the disc. In the case of discs and changers that do not support text, searches can be made using the track numbers.

- 1 Press  during play.**
This will set the search mode.
- 2 Select the desired track (file) by sliding your finger on the **GlideTouch bar** to the left or right. Press the **GlideTouch bar** under the text of the desired track.**
This will play the selected track.
 - Press and hold  for at least 2 seconds in the search mode to cancel. Or, the search mode will be cancelled when an operation has not been performed for 10 seconds.
 - CD text search cannot be made during M.I.X. play.
 - Tracks are skipped continuously by touching and holding either side of the **GlideTouch bar**.
 - You can speed up your search by moving your finger quickly on the **GlideTouch bar** to skip tracks.

File/Folder Name Search (concerning MP3/WMA)

You can display and search for the folder and file name while listening to the file currently being played back.

- 1 Press  in MP3/WMA mode.**
- 2 Within 10 seconds, select the folder search mode or file search mode by sliding your finger on the **GlideTouch bar** to the left or right. Press the **GlideTouch bar** under the desired search mode.**

Folder name search mode ↔ File name search mode



Folder Name Search mode

The desired folder is searched from all folders in a disc.

File Name Search mode



File is searched from all files in a disc or folder that is selected by folder search.

Folder Name Search mode

- 3 Within 10 seconds, select the folder to play back by sliding your finger on the **GlideTouch bar** to the left or right. Press **▶/||** to play the selected folder.**
The first file in the selected folder is played back.
To search for a file in the selected folder, press the **GlideTouch bar** or **FUNC.** to change to the file search mode. Refer to "File Name Search mode" for operation.
 - Search mode is cancelled by pressing and holding  for at least 2 seconds in Folder Name Search mode.
 - While in File Name Search mode, press  to return to the selecting search mode.
 - "NO FILE" is displayed for 2 seconds if the folder that is selected by the Folder Name Search mode contains no files.
 - "ROOT" is displayed for a root folder that does not have a folder name.
 - Folder Name search cannot be made during M.I.X. play.
 - If a disc contains only the root folder, Folder Name Search cannot be made.



- Folders are skipped continuously by touching and holding either side of the **GlideTouch bar**.
- You can speed up your search by moving your finger quickly on the **GlideTouch bar** to skip folders.

File Name Search mode

- 3 Within 10 seconds, select the file to play back by sliding your finger on the **GlideTouch bar** to the left or right. Press the **GlideTouch bar** or **FUNC.** to play the selected file.**
The selected file is played back.
 - File Name Search mode is cancelled by pressing and holding  for at least 2 seconds.
 - While in File Name Search mode, press  to switch to the previous mode (folder search mode or selecting search mode).
 - File Name search cannot be made during M.I.X. play.
 - Files are skipped continuously by touching and holding either side of the **GlideTouch bar**.
 - You can speed up your search by moving your finger quickly on the **GlideTouch bar** to skip files.

Quick Search

You can search for tracks (files).

- 1 Press and hold  for at least 2 seconds in the CD/Changer/MP3/WMA mode to activate Quick Search mode.**
- 2 Within 10 seconds, select the track (file) to play back by sliding your finger on the **GlideTouch bar** to the left or right.**
The selected track is played back immediately.
 - Search mode is cancelled by pressing and holding  for at least 2 seconds in Quick Search mode.
 - Tracks (files) are skipped continuously by touching and holding either side of the **GlideTouch bar**.
 - You can speed up your search by moving your finger quickly on the **GlideTouch bar** to skip tracks (files).

About MP3/WMA

CAUTION

Except for private use, duplicating audio data (including MP3/WMA data) or distributing, transferring, or copying it, whether for free or for a fee, without permission of the copyright holder is strictly prohibited by the Copyright Act and by international treaty.

What is MP3?

MP3, whose official name is "MPEG-1 Audio Layer 3," is a compression standard prescribed by the ISO, the International Standardization Organization and MPEG which is a joint activity institution of the IEC.

MP3 files contain compressed audio data. MP3 encoding is capable of compressing audio data at extremely high ratios, reducing the size of music files to as much as one-tenth their original size. This is achieved while still maintaining near CD quality. The MP3 format realizes such high compression ratios by eliminating the sounds that are either inaudible to the human ear or masked by other sounds.

Continued

What is WMA?

WMA, or "Windows Media™ Audio," is compressed audio data. WMA allows you to create music files and store them at higher ratios of compression than MP3 audio data (approx. half original size). This is achieved while still maintaining CD quality sound.

Method for creating MP3/WMA files

Audio data is compressed by using MP3/WMA specified software. For details on creating MP3/WMA files, refer to the user's manual for that software. MP3/WMA files that can be played back by this device have the file extension "mp3" / "wma". Files with no extension cannot be played back. (WMA ver. 7.1, 8 and 9 are supported)

Supported playback sampling rates and bit rates

MP3

Sampling rates : 48 kHz, 44.1 kHz, 32 kHz, 24 kHz, 22.05 kHz, 16 kHz, 12 kHz, 11.025 kHz, 8 kHz
Bit rates: 8 - 320 kbps

WMA

Sampling rates : 48 kHz, 44.1 kHz, 32 kHz
Bit rates: 48 - 192 kbps

Note that for sampling rates, this device's frame display (Page 13) may not display correctly. This device may not play back correctly depending on sampling rates.

ID3 tags/WMA tags

This device supports ID3 tag v1 and v2, and WMA tag. If tag data is in an MP3/WMA file, this device can display the title (track title), artist name, and album name ID3 tag/WMA tag data.

This device can only display single-byte alphanumeric characters (up to 30 for ID3 tags and up to 15 for WMA tags) and the underscore. For non-supported characters, "NO SUPPORT" is displayed.

The tag information may not be correctly displayed, depending on the contents.

Producing MP3/WMA discs

MP3/WMA files are prepared, then written to a CD-R or CD-RW using CD-R writing software. A disc can hold up to 510 files/folders (including Root Folders). However, the maximum number of folders is 255.

Media supported

The media that this device can play back are CD-ROMs, CD-Rs, and CD-RWs.

Corresponding File Systems

This device supports discs formatted with ISO9660 Level 1 or Level 2.

Under the ISO9660 standard, there are some restrictions to remember. The maximum nested folder depth is 8 (including the root directory). The number of characters for a folder/file name is limited. Valid characters for folder/file names are letters A-Z (all caps), numbers 0-9, and '_' (underscore).

This device also can play back discs in Joliet, Romeo, etc., and other standards that conform to ISO9660. However, sometimes the file names, folder names, etc., are not displayed correctly.

Formats supported

This device supports CD-ROM XA, Mixed Mode CD, Enhanced CD (CD-Extra) and Multi-Session. This device cannot correctly play back discs recorded with Track At Once or packet writing.

Order of files

The unit plays the files in the order that the writing software writes them. Therefore, the playing order may not be the same as the order you input. The playback order of the folders and files is as follows. However, the folder and file playback order differs from the folder no. and file no. indicated on the display.

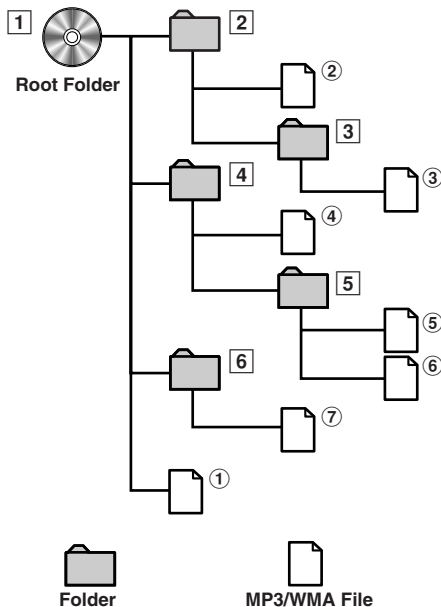

Terminology

Bit rate

This is the "sound" compression rate specified for encoding. The higher the bit rate, the higher the sound quality, but also the larger the files.

Sampling rate

This value shows how many times per second the data is sampled (recorded). For example, music CDs use a sampling rate of 44.1 kHz, so the sound is sampled (recorded) 44,100 times per second. The higher the sampling rate, the higher the sound quality, but also the larger the volume of data.

Encoding

Converting music CDs, WAVE (AIFF) files, and other sound files into the specified audio compression format.

Tag

Song information such as track titles, artist names, album names, etc., written into MP3/WMA files.

MP3: ID3 tag

WMA: WMA tag

Root folder

The root folder is found at the top of the file system. The root folder contains all folders and files.

Sound Setting

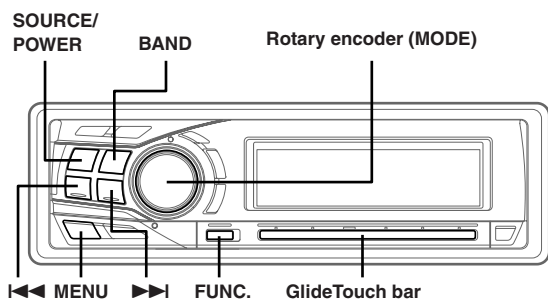

Adjusting Balance (Between Left and Right)/Fader (Between Front and Rear)/Deafat

1 Press the Rotary encoder (MODE) repeatedly to choose the desired mode.

Each press changes the modes as follows:

SUBWOOFER*[†] → BALANCE → FADER → DEFEAT → VOLUME → SUBWOOFER*[†]

Subwoofer : 0 ~ +15
Balance : L15 ~ R15
Fader : R15 ~ F15
Defeat : ON/OFF
Volume : 0 ~ 35

Press ◀◀ or ▶▶ after selecting the Subwoofer mode, and the subwoofer output phase is switched NORMAL (PHASE 0°) or REVERS (PHASE 180°).

- If the Rotary encoder (MODE) is not pressed within 5 seconds after selecting the BALANCE, FADER, DEFEAT or SUBWOOFER mode, the unit automatically returns to normal mode.
- If you set the 2WAY/3WAY switch (pages 42 to 44) to 3WAY, you cannot adjust the FADER mode.

*[†] When the subwoofer mode is set to OFF, its level and phase cannot be adjusted.

2 Turn the Rotary encoder (MODE) until the desired sound is obtained in each mode.

By setting Deafat ON, previously adjusted settings of EQ will return to the factory defaults and MX is turned off.

- Depending on the connected devices, some functions and display indications do not work.

Equalizer Presets

9 typical equalizer settings are preset at the factory for a variety of musical source material.

1 Press MENU.

2 Select the Factory's EQ mode by sliding your finger on the GlideTouch bar to the left or right. Press the GlideTouch bar under the Factory's EQ mode.

3 Select the desired equalizer characteristic by sliding your finger on the GlideTouch bar to the left or right.

- By selecting USER'S 1 to 6, you can recall the stored preset number in "Adjusting and Storing the Parametric Equalizer Curve" (page 18) or "Adjusting and Storing the Graphic Equalizer Curve" (page 18).

4 Press and hold MENU for at least 2 seconds to return to normal mode.

- If MENU is pressed while adjusting or setting items in the MENU mode, the unit will return to the previous selection screen.
- By pressing the GlideTouch bar under RETURN in the MENU mode, the unit returns to the normal mode.
- This function is inoperable when DEFEAT is set to ON (this page).

Setting User's EQ mode

This setting gives you a choice of 5-band parametric, or 7-band graphic equalizer.

1 Press MENU.

2 Select SETUP by sliding your finger on the GlideTouch bar to the left or right. Press the GlideTouch bar under SETUP.

The main SETUP menu is displayed.

3 Select AUDIO by sliding your finger on the GlideTouch bar to the left or right. Press the GlideTouch bar under AUDIO.

The AUDIO SETUP menu is displayed.

4 Select EQ MODE by sliding your finger on the GlideTouch bar to the left or right. Press the GlideTouch bar under EQ MODE.

5 Select EQ Type by sliding your finger on the GlideTouch bar to the left or right. Press the GlideTouch bar under PEQ or GEQ.

PEQ : 5-band parametric EQ (initial setting)
GEQ : 7-band graphic EQ

6 Press and hold MENU for at least 2 seconds to return to normal mode.

- If MENU is pressed while adjusting or setting items in the MENU mode, the unit will return to the previous selection screen.
- By pressing the GlideTouch bar under RETURN in the MENU mode, the unit returns to the normal mode.

Adjusting and Storing the Parametric Equalizer Curve

You can modify the Equalizer settings to create a response curve more appealing to your personal taste.

To adjust the parametric equalizer curve, set the EQ mode to PEQ. For details, refer to “Setting User’s EQ mode” (page 17).

- 1 Press and hold **MENU** for at least 2 seconds.
- 2 Select the Parametric EQ (User’s EQ) mode by sliding your finger on the **GlideTouch bar** to the left or right. Press the **GlideTouch bar** under the Parametric EQ (User’s EQ) mode.
- 3 Press **BAND** to select the band to be adjusted.
BAND1 → BAND2 → BAND3 → BAND4 → BAND5 → BAND1
- 4 Select the frequency by sliding your finger on the **GlideTouch bar** to the left or right.
Adjustable frequency bands:
20Hz to 20kHz (in 1/3 octave steps)
- 5 Adjust the level by turning the **Rotary encoder**.
Adjustable level: -6 to + 6 dB
- 6 Press **SOURCE/POWER** to set the band width (Q).
Adjustable band width: 1.0, 1.5, 3.0
- 7 To adjust another band, repeat steps 3 to 6 and adjust all bands.
- 8 When the setting has been completed, press **FUNC.** or the **GlideTouch bar** to activate the preset mode.
- 9 Select any one of the preset numbers (1 through 6) by sliding your finger on the **GlideTouch bar** to the left or right. Press and hold the **GlideTouch bar** under the desired preset for at least 2 seconds to store the adjusted contents.
- 10 After setting, press and hold **MENU** for at least 2 seconds to return to normal mode.

- The frequencies of adjacent bands cannot be adjusted within 4 steps.
- This function is inoperable when DEFEAT is set to ON (page 17).
- If **MENU** is pressed while adjusting or setting items in the **MENU** mode, the unit will return to the previous selection screen.
- By pressing the **GlideTouch bar** under **RETURN** in the **MENU** mode, the unit returns to the normal mode.
- If no operation is performed for 60 seconds, the unit returns to normal mode.

Adjusting and Storing the Graphic Equalizer Curve

You can modify the equalizer settings to create a response curve to your personal taste. To adjust the graphic equalizer curve, set the EQ mode to GEQ. For details, refer to “Setting User’s EQ mode” (page 17).

- 1 Press and hold **MENU** for at least 2 seconds.
- 2 Select the Graphic EQ (User’s EQ) mode by sliding your finger on the **GlideTouch bar** to the left or right. Press the **GlideTouch bar** under the Graphic EQ (User’s EQ) mode.
- 3 Press **BAND** to select the band to be adjusted.
BAND1 → BAND2 → BAND3 → BAND4 → BAND5 → BAND6 → BAND7 → BAND1
- 4 Adjust the level by turning the **Rotary encoder**.
Adjustable output level: -6 to + 6 dB
- 5 To adjust another band, repeat steps 3 and 4, then adjust all bands.
- 6 When the setting has been completed, press **FUNC.** or the **GlideTouch bar** to activate the preset mode.
- 7 Select any one of the preset numbers (1 through 6) by sliding your finger on the **GlideTouch bar** to the left or right. Press and hold the **GlideTouch bar** under the desired preset for at least 2 seconds to store the adjusted contents.
- 8 After setting, press and hold **MENU** for at least 2 seconds to return to normal mode.

- This function is inoperable when DEFEAT is set to ON (page 17).
- If **MENU** is pressed while adjusting or setting items in the **MENU** mode, the unit will return to the previous selection screen.
- By pressing the **GlideTouch bar** under **RETURN** in the **MENU** mode, the unit returns to the normal mode.
- If no operation is performed for 60 seconds, the unit returns to normal mode.

Recalling the Stored Equalizer Curve

- 1 Press and hold **MENU** for at least 2 seconds.
- 2 Select the EQ mode by sliding your finger on the **GlideTouch** bar to the left or right. Press the **GlideTouch** bar under the EQ mode.
- 3 Press **FUNC.** or the **GlideTouch** bar to activate the preset mode.
- 4 Select any one of the preset numbers (1 through 6) by sliding your finger on the **GlideTouch** bar to the left or right. Press the **GlideTouch** bar under the desired preset to recall the stored contents.
- 5 Press and hold **MENU** for at least 2 seconds to return to normal mode.

- This function is inoperable when **DEFEAT** is set to **ON** (page 17).
- You can recall the adjusted equalizer curve from "Equalizer Presets" (page 17).
- If **MENU** is pressed while adjusting or setting items in the **MENU** mode, the unit will return to the previous selection screen.
- By pressing the **GlideTouch** bar under **RETURN** in the **MENU** mode, the unit returns to the normal mode.
- If no operation is performed for 60 seconds, the unit returns to normal mode.

About the Crossover

Crossover:

This unit is equipped with an active crossover. The crossover limits the frequencies delivered to the outputs. Each channel is controlled independently. Thus, each speaker pair can be driven by the frequencies for which they have been optimally designed. The crossover adjusts the HPF (high pass filter) or LPF (low pass filter) of each band, and also the slope (how fast the filter rolls off the highs or lows). Adjustments should be made according to the reproduction characteristics of the speakers. Depending on the speakers, a passive network may not be necessary. If you are unsure about this point, please consult your authorized Alpine dealer.

2 way mode

	Cut-off frequency (1/3 octave steps)		Slope		Level
	HPF	LPF	HPF	LPF	
Low range speaker	----	20 Hz - 200 Hz	----	FLAT, 6, 12, 18, 24 dB/oct	0 to -12 dB
Rear high range speaker	20 Hz - 200 Hz	----	FLAT, 6, 12, 18, 24 dB/oct	----	0 to -12 dB
Front high range speaker	20 Hz - 200 Hz	----	FLAT, 6, 12, 18, 24 dB/oct	----	0 to -12 dB

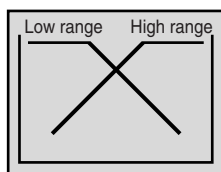

(Different from actual display)

3 way mode

	Cut-off frequency (1/3 octave steps)		Slope		Level
	HPF	LPF	HPF	LPF	
Low range speaker	----	20 Hz - 200 Hz	----	FLAT, 6, 12, 18, 24 dB/oct	0 to -12 dB
Mid range speaker	20 Hz - 200 Hz	20 Hz - 20 kHz	FLAT, 6, 12, 18, 24 dB/oct	FLAT, 6, 12, 18, 24 dB/oct	0 to -12 dB
High range speaker	1 kHz - 20 kHz	----	FLAT* ¹ 6, 12, 18, 24 dB/oct	----	0 to -12 dB

*¹ Only when selecting **USER'S** in "Setting the Response Slope for the High Range Speaker (TW SETUP)" (page 31).

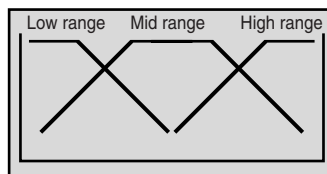

(Different from actual display)

Level adjusting (0 to -12 dB)

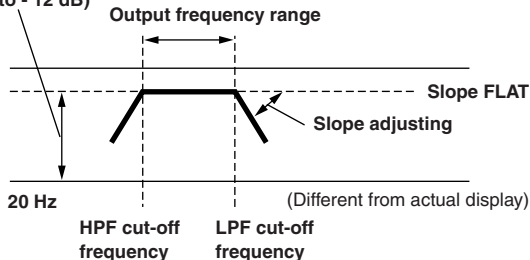

- **HPF (high pass filter):** Cuts the lower frequencies and allows the higher frequencies to pass.
- **LPF (low pass filter):** Cuts the higher frequencies and allows the lower frequencies to pass.
- **Slope:** The level change (in dB) for a frequency change of one octave.
- The higher the slope value, the steeper the slope becomes.
- Adjust the slope to **FLAT** to bypass the HP or LP filters.
- Do not use a tweeter without the HPF on or set to a low frequency, as it may cause damage to the speaker due to the low frequency content.
- You cannot adjust the crossover frequency higher than the HPF or lower than the LPF.
- Adjustment should be made according to the recommended crossover frequency of the connected speakers. Determine the recommended crossover frequency of the speakers. Adjusting to a frequency range outside that recommended may cause damage to the speakers.

For the recommended crossover frequencies of Alpine speakers, refer to the respective Owner's Manual.

We are not responsible for damage or malfunction of speakers caused by using the crossover outside the recommended value.

Adjusting and Storing the Crossover Settings

Before performing the following procedures, refer to “About the Crossover” (Page 19).

- 1 Press and hold **MENU** for at least 2 seconds.
- 2 Select the Crossover (X-OVER) mode by sliding your finger on the **GlideTouch bar** to the left or right. Press the **GlideTouch bar** under the Crossover (X-OVER) mode.

2 WAY System

- 3 Press **BAND** to select the band to be adjusted.
LOW → MID → HIGH → LOW
(SUBW) (REAR) (FRONT) (SUBW)
- 4 Select the desired cut-off frequency (Crossover Point) by sliding your finger on the **GlideTouch bar** to the left or right.
Adjustable frequency bands: 20Hz to 200Hz
(in 1/3 octave steps)
- 5 Press **SOURCE/POWER** to adjust the slope.
Adjustable slope: 0 (FLAT), 1 (6dB/oct.), 2 (12dB/oct.)
3 (18dB/oct.) 4 (24dB/oct.)
- 6 Adjust the output level by turning the **Rotary encoder**.
Adjustable output level: -12 to 0 dB.
- 7 To adjust another band, repeat steps 3 to 6, then adjust all bands.
- 8 When the setting has been completed, press **FUNC.** or the **GlideTouch bar** to activate the preset mode.
- 9 Select any one of the preset numbers (1 through 6) by sliding your finger on the **GlideTouch bar** to the left or right. Press and hold the **GlideTouch bar** under the desired preset for at least 2 seconds to store the adjusted contents.

10 After setting, press and hold **MENU** for at least 2 seconds to return to normal mode.

- If **MENU** is pressed while adjusting or setting items in the **MENU** mode, the unit will return to the previous selection screen.
- By pressing the **GlideTouch bar** under **RETURN** in the **MENU** mode, the unit returns to the normal mode.
- If no operation is performed for 60 seconds, the unit returns to normal mode.

3 WAY System

- 3 Press **BAND** to select the band to be adjusted.
LOW → MID-L → MID-H → HIGH → LOW
- 4 Select the desired cut-off frequency (Crossover Point) by sliding your finger on the **GlideTouch bar** to the left or right.
Adjustable frequency bands:
LOW: 20Hz to 200Hz (in 1/3 octave steps)
MID-L: 20Hz to 200Hz (in 1/3 octave steps)
MID-H: 20Hz to 20kHz (in 1/3 octave steps)
HIGH: 1kHz to 20 kHz (in 1/3 octave steps)
- 5 Press **SOURCE/POWER** to adjust the slope.
Adjustable slope: 0 (FLAT)*, 1 (6dB/oct.), 2 (12dB/oct.)
3 (18dB/oct.) 4 (24dB/oct.)
- 6 Adjust the output level by turning the **Rotary encoder**.
Adjustable output level: -12 to 0 dB.
- 7 To adjust another band, repeat steps 3 to 6, then adjust all bands.
- 8 When the setting has been completed, press **FUNC.** or the **GlideTouch bar** to activate the preset mode.
- 9 Select any one of the preset numbers (1 through 6) by sliding your finger on the **GlideTouch bar** to the left or right. Press and hold the **GlideTouch bar** under the desired preset for at least 2 seconds to store the adjusted contents.
- 10 After setting, press and hold **MENU** for at least 2 seconds to return to normal mode.

- If **MENU** is pressed while adjusting or setting items in the **MENU** mode, the unit will return to the previous selection screen.
- By pressing the **GlideTouch bar** under **RETURN** in the **MENU** mode, the unit returns to the normal mode.
- If no operation is performed for 60 seconds, the unit returns to normal mode.
- About the 2way/3way system
You can switch to 2way/3way system mode with the 2way/3way switch on the bottom side of the unit (pages 42 to 44).



When setting to “3 WAY”:

The unit can be operated in a 3 way system.

When setting to “F/R/Sub-W”:

The unit can be operated in a 2 way system.

Recalling the Stored Crossover Settings

- 1 Press and hold **MENU** for at least 2 seconds.
- 2 Select the Crossover (**X-OVER**) mode by sliding your finger on the **GlideTouch** bar to the left or right. Press the **GlideTouch** bar under the Crossover (**X-OVER**) mode.
- 3 Press **FUNC.** or the **GlideTouch** bar to activate the preset mode.
- 4 Select any one of the preset numbers (1 through 6) by sliding your finger on the **GlideTouch** bar to the left or right. Press the **GlideTouch** bar under the desired preset to recall the stored contents.
- 5 Press and hold **MENU** for at least 2 seconds to return to normal mode.

- If **MENU** is pressed while adjusting or setting items in the **MENU** mode, the unit will return to the previous selection screen.
- By pressing the **GlideTouch** bar under **RETURN** in the **MENU** mode, the unit returns to the normal mode.

About Time Correction

The distance between the listener and the speakers in a car vary widely due to the complex speaker placement. This difference in the distances from the speakers to the listener creates a shift in the sounds image and frequency characteristics. This is caused by the time delay between the sound reaching the listener's right versus the left ear. To correct this, the CDA-9855R/CDA-9853R is able to delay the audio signal to the speakers closest to the listener. This effectively creates a perception of increased distance for those speakers. The listener can be placed at an equal distance between the left and right speakers for optimum staging.

The adjustment will be made for each speaker in 0.1 ms steps.

Example 1. Listening Position: Front Left Seat

Adjust the time correction level of the front left speaker to a high value and the rear right to zero or a low value.

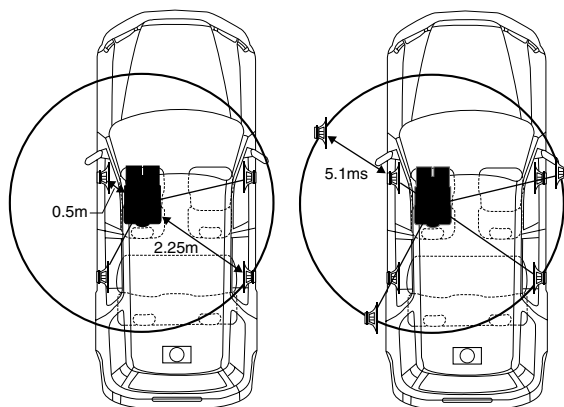

The sound is not balanced because the distance between the listening position and the various speakers is different. The difference in distance between the front left speaker and the rear right speaker is 1.75 m (68-7/8").

Here we calculate the time correction value for the front left speaker in the diagram on the above.

Conditions:

Farthest Speaker – listening position : 2.25 m (88-9/16")

Front left speaker – listening position : 0.5 m (19-11/16")

Calculation: $L = 2.25 \text{ m} - 0.5 \text{ m} = 1.75 \text{ m}$ (68-7/8")

Time correction = $1.75 \div 343^{*1} \times 1000 = 5.1 \text{ (ms)}$

**1 Speed of sound: 343 m/s (765 mph) at 20°C*

In other words, giving the front left speaker a time correction value of 5.1 ms makes it seem as if its distance from the listener is the same as the distance to the farthest speaker.

Time correction eliminates the differences in the time required for the sound to reach the listening position.

The time of the front left speaker is corrected by 5.1 ms so that its sound reaches the listening position at the same time as the sound of other speakers.

Example 2. Listening Position: All Seats

Adjust the time correction level of each speaker to almost the same level.

- 1 Sit in the listening position (driver's seat, etc.) and measure the distance (in meters) between your head and the various speakers.
- 2 Calculate the difference between the distance to the farthest speaker and the other speakers.
 $L = (\text{distance to farthest speaker}) - (\text{distance to other speakers})$
- 3 Divide the distances calculated for the speakers by the speed of sound (343 m/s (765 mph) at 20°C).
 These values are the time correction values for the different speakers.

Time Difference Table

Delay Number	Time Difference (ms)	Distance (cm)	Distance (inch)	Delay Number	Time Difference (ms)	Distance (cm)	Distance (inch)
0	0.0	0.0	0.0	51	5.1	173.4	68.3
1	0.1	3.4	1.3	52	5.2	176.8	69.7
2	0.2	6.8	2.7	53	5.3	180.2	71.0
3	0.3	10.2	4.0	54	5.4	183.6	72.4
4	0.4	13.6	5.4	55	5.5	187.0	73.7
5	0.5	17.0	6.7	56	5.6	190.4	75.0
6	0.6	20.4	8.0	57	5.7	193.8	76.4
7	0.7	23.8	9.4	58	5.8	197.2	77.7
8	0.8	27.2	10.7	59	5.9	200.6	79.1
9	0.9	30.6	12.1	60	6.0	204.0	80.4
10	1.0	34.0	13.4	61	6.1	207.4	81.7
11	1.1	37.4	14.7	62	6.2	210.8	83.1
12	1.2	40.8	16.1	63	6.3	214.2	84.4
13	1.3	44.2	17.4	64	6.4	217.6	85.8
14	1.4	47.6	18.8	65	6.5	221.0	87.1
15	1.5	51.0	20.1	66	6.6	224.4	88.4
16	1.6	54.4	21.4	67	6.7	227.8	89.8
17	1.7	57.8	22.8	68	6.8	231.2	91.1
18	1.8	61.2	24.1	69	6.9	234.6	92.5
19	1.9	64.6	25.5	70	7.0	238.0	93.8
20	2.0	68.0	26.8	71	7.1	241.4	95.1
21	2.1	71.4	28.1	72	7.2	244.8	96.5
22	2.2	74.8	29.5	73	7.3	248.2	97.8
23	2.3	78.2	30.8	74	7.4	251.6	99.2
24	2.4	81.6	32.2	75	7.5	255.0	100.5
25	2.5	85.0	33.5	76	7.6	258.4	101.8
26	2.6	88.4	34.8	77	7.7	261.8	103.2
27	2.7	91.8	36.2	78	7.8	265.2	104.5
28	2.8	95.2	37.5	79	7.9	268.6	105.9
29	2.9	98.6	38.9	80	8.0	272.0	107.2
30	3.0	102.0	40.2	81	8.1	275.4	108.5
31	3.1	105.4	41.5	82	8.2	278.8	109.9
32	3.2	108.8	42.9	83	8.3	282.2	111.2
33	3.3	112.2	44.2	84	8.4	285.6	112.6
34	3.4	115.6	45.6	85	8.5	289.0	113.9
35	3.5	119.0	46.9	86	8.6	292.4	115.2
36	3.6	122.4	48.2	87	8.7	295.8	116.6
37	3.7	125.8	49.6	88	8.8	299.2	117.9
38	3.8	129.2	50.9	89	8.9	302.6	119.3
39	3.9	132.6	52.3	90	9.0	306.0	120.6
40	4.0	136.0	53.6	91	9.1	309.4	121.9
41	4.1	139.4	54.9	92	9.2	312.8	123.3
42	4.2	142.8	56.3	93	9.3	316.2	124.6
43	4.3	146.2	57.6	94	9.4	319.6	126.0
44	4.4	149.6	59.0	95	9.5	323.0	127.3
45	4.5	153.0	60.3	96	9.6	326.4	128.6
46	4.6	156.4	61.6	97	9.7	329.8	130.0
47	4.7	159.8	63.0	98	9.8	333.2	131.3
48	4.8	163.2	64.3	99	9.9	336.6	132.7
49	4.9	166.6	65.7				
50	5.0	170.0	67.0				

Setting the Time Correction Unit

You can change the unit, (ms, cm or inch) of time correction.

- 1 Press **MENU**.
- 2 Select **SETUP** by sliding your finger on the **GlideTouch bar** to the left or right. Press the **GlideTouch bar** under **SETUP**.
The main SETUP menu is displayed.
- 3 Select **DISP (DISPLAY)** by sliding your finger on the **GlideTouch bar** to the left or right. Press the **GlideTouch bar** under **DISP (DISPLAY)**.
The DISPLAY SETUP menu is displayed.
- 4 Select **T.CORR (T.CORR PAR)** by sliding your finger on the **GlideTouch bar** to the left or right. Press the **GlideTouch bar** under **T.CORR (T.CORR PAR)**.
- 5 Select **ms (MS)**, **cm (CM)** or **inch (INCH)** by sliding your finger on the **GlideTouch bar** to the left or right. Press the **GlideTouch bar** under **ms (MS)**, **cm (CM)** or **inch (INCH)** to select the unit.
- 6 After setting, press and hold **MENU** for at least 2 seconds to return to normal mode.

- If **MENU** is pressed while adjusting or setting items in the **MENU** mode, the unit will return to the previous selection screen.
- By pressing the **GlideTouch bar** under **RETURN** in the **MENU** mode, the unit returns to the normal mode.

Adjusting and Storing the Time Correction

Before performing the following procedures, refer to "About Time Correction" (page 21).

- 1 Press and hold **MENU** for at least 2 seconds.
- 2 Select **Time Correction (T.CORR)** mode by sliding your finger on the **GlideTouch bar** to the left or right. Press the **GlideTouch bar** under **Time Correction (T.CORR)**.
- 3 Press **BAND** to select a speaker to be adjusted.
F - L → F - R → R - L → R - R → SW - L (S - L) → SW - R (S - R) → F - L
- 4 Adjust the time difference (0.0 to 9.9 ms) or distance by sliding your finger on the **GlideTouch bar** to the left or right. Or turn the **Rotary encoder** to adjust time difference.
- 5 Repeat steps 3 and 4 to set another speaker.
- 6 When the setting has been completed, Press **FUNC.** or the **GlideTouch bar** to activate the preset mode.

7 Select any one of the preset numbers (1 through 6) by sliding your finger on the **GlideTouch bar** to the left or right. Press and hold the **GlideTouch bar** under the desired preset for at least 2 seconds to store the adjusted contents.

8 After setting, press and hold **MENU** for at least 2 seconds to return to normal mode.

- If **MENU** is pressed while adjusting or setting items in the **MENU** mode, the unit will return to the previous selection screen.
- By pressing the **GlideTouch bar** under **RETURN** in the **MENU** mode, the unit returns to the normal mode.
- If no operation is performed for 60 seconds, the unit returns to normal mode.

Recalling the Stored Time Correction Settings

1 Press and hold **MENU** for at least 2 seconds.

2 Select the Time Correction (T.CORR) mode by sliding your finger on the **GlideTouch bar** to the left or right. Press the **GlideTouch bar** under the Time Correction (T.CORR) mode.

3 Press **FUNC.** or the **GlideTouch bar** to activate the preset mode.

4 Select any one of the preset numbers (1 through 6) by sliding your finger on the **GlideTouch bar** to the left or right. Press the **GlideTouch bar** under the desired preset to recall the stored contents.

5 Press and hold **MENU** for at least 2 seconds to return to normal mode.

- If **MENU** is pressed while adjusting or setting items in the **MENU** mode, the unit will return to the previous selection screen.
- By pressing the **GlideTouch bar** under **RETURN** in the **MENU** mode, the unit returns to the normal mode.

Setting the MX Mode

MX (Media Xpander) makes vocals or instruments sound distinct regardless of the music source. The FM radio, CD, and MP3, will be able to reproduce the music clearly even in cars with a lot of road noise.

1 Press **MENU**.

2 Select the MX mode by sliding your finger on the **GlideTouch bar** to the left or right. Press the **GlideTouch bar** under the MX mode.

3 Press the **GlideTouch bar** under **ON** to activate MX.

4 After setting, press and hold **MENU** for at least 2 seconds to return to normal mode.

5 Press **SOURCE/POWER** to select the source to which you want to apply MX (Media Xpander).

6 Press and hold **MENU** for at least 2 seconds.

7 Select the MX mode by sliding your finger on the **GlideTouch bar** to the left or right. Press the **GlideTouch bar** under the MX mode.

8 Select the MX level by sliding your finger on the **GlideTouch bar** to the left or right. Press the **GlideTouch bar** under the desired level or **OFF** (Non Effect).

FM (MX level 1 to 3):

The medium to high frequencies become clearer, and produces well balanced sound at all frequencies.

CD (MX level 1 to 3):

CD mode processes a large amount of data during playback. MX takes advantage of this large data quantity to reproduce a more clear, clean output.

CMPM (MX level 1 to 3):

This corrects information that was lost at the time of compression. This reproduces a well-balanced sound close to the original.

DVD (Video CD)

(MOVIE MX level 1 to 2):

The dialogue portion of a video is reproduced more clearly.

(DVD MUSIC):

A DVD or Video CD contains a large quantity of data such as music clip. MX uses this data to reproduce the sound accurately.

AUX (MX level 1):

Choose the MX mode (CMPM, MUSIC, or MOVIE) that corresponds to the media connected.

If two external devices are connected, a different MX mode for each media can be selected.

9 After setting, press and hold **MENU** for at least 2 seconds to return to normal mode.

- To cancel MX mode for all music sources, set MX to OFF in step 3.
- Each music source, such as FM radio, CD, and MP3/WMA can have its own MX setting.
- On disks with both MP3/WMA and CD-DA, when the source changes from "MP3/WMA to CD-DA" or "CD-DA to MP3/WMA", MX-mode switching may delay playback slightly.
- Setting to MX OFF sets MX mode of each music source to OFF.
- This function is inoperable when DEFEAT is set to ON.
- There is no MX mode for MW/LW radio.
- If an audio processor with the MX function (PXA-H701, etc.) is connected, its own MX processing is applied to the music source. Since the processor MX settings may not match the head unit, the audio processor needs to be adjusted. For details, refer to the Owner's Manual of the audio processor.
- When entering RDS signals, the MX operation cannot be performed.
- "CMPM" is applied for MP3/WMA, WAV and iPod.
- If **MENU** is pressed while adjusting or setting items in the **MENU** mode, the unit will return to the previous selection screen.
- By pressing the **GlideTouch bar** under **RETURN** in the **MENU** mode, the unit returns to the normal mode.
- If no operation is performed for 60 seconds, the unit returns to normal mode.

About the MX indicator display (CDA-9853R only)

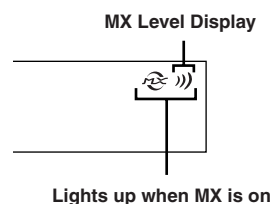

Other Functions

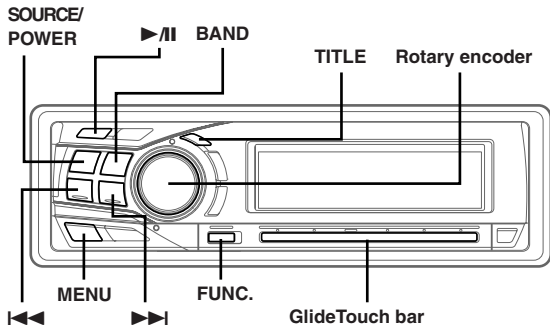

Displaying the Title/Text

It is possible to display the CD/Station title if the title has been previously inputted (“Titling Discs/Stations” page 25). Text information, such as the disc name and the track name, will be displayed if playing a CD text compatible disc. It is also possible to display the folder name, the file name, and the tag, etc., while playing MP3/WMA files.

Press **TITLE**.

The display will change every time the button is pressed.

The display in Radio mode:

CDA-9855R

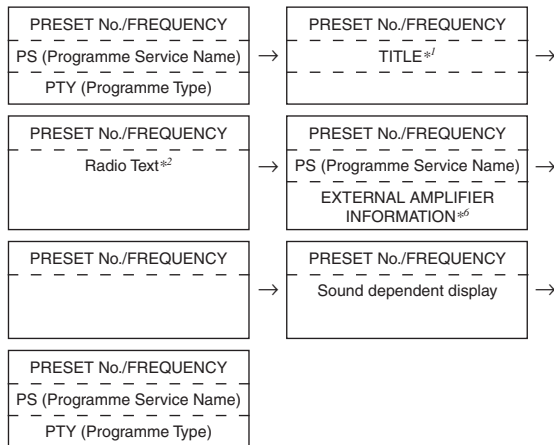

CDA-9853R

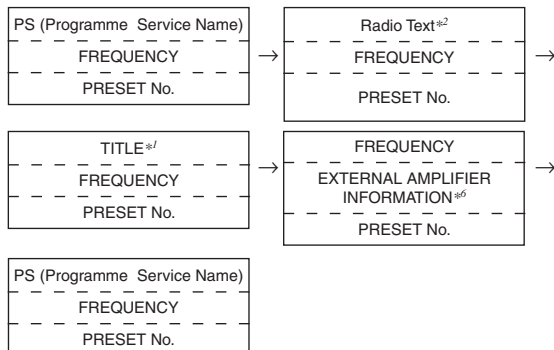

The display in CD mode:

CDA-9855R

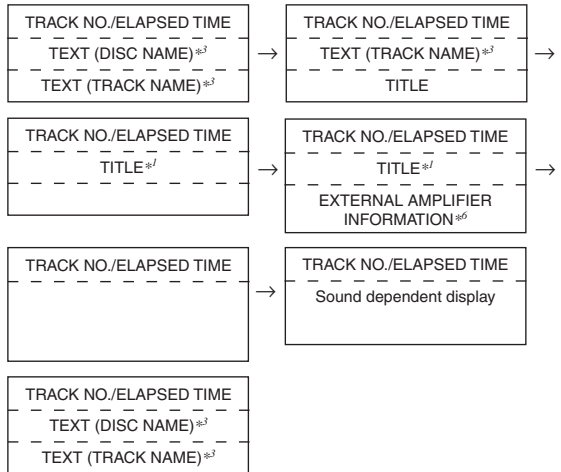

CDA-9853R

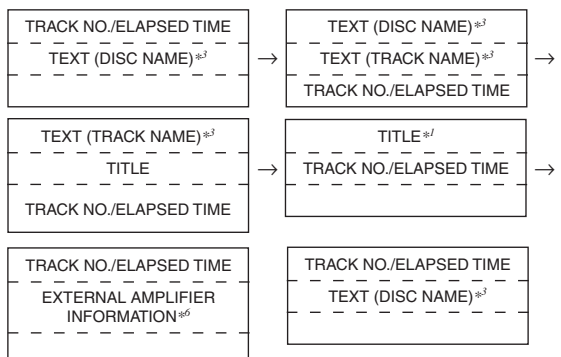

The display in MP3/WMA mode:

CDA-9855R

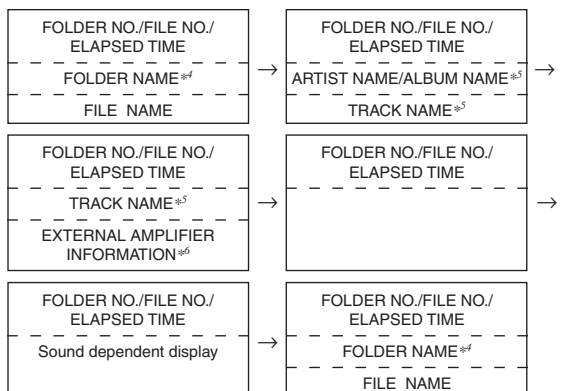

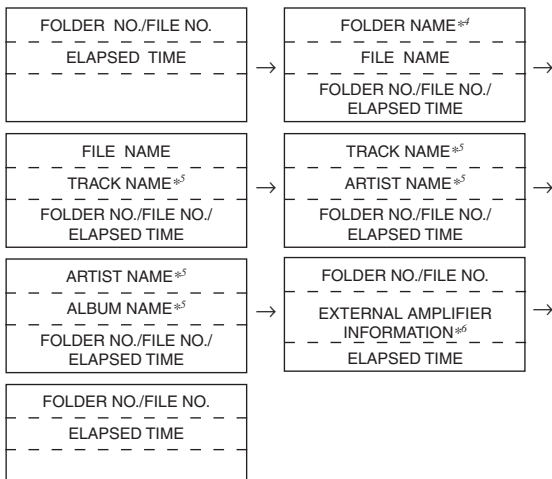

*1 *TITLE* can be input or erased.

*2 If there is no receivable text message or the unit cannot receive a text message properly, the display shows "NO TEXT."

*3 Displayed during playback of a disc with CD Text.
"NO TEXT" will be displayed when the CD contains no Text data.
*4 "ROOT" is displayed for a root folder that does not have a folder name.

*5 ID3 tag/WMA tag
If an MP3/WMA file contains ID3 tag/WMA tag information, the ID3 tag/WMA tag information is displayed (e.g., track name, artist name, and album name). All other tag data is ignored.
"NO DATA" will be displayed when an MP3/WMA file contains no ID3 tag/WMA tag information.

*6 Only when an external Amplifier Link compatible amplifier is connected. For details, refer to "Displaying the External Amplifier Information" (page 27).

About "Title" and "Text"

Title:

With this device, it is possible to input the CD/Station name (this page). This inputted name is referred to as a "title."
You cannot input or display titles on MP3/WMA discs.

Text:

Text compatible CDs contain text information such as the disc name and track name. Such text information is referred to as "text."

- Some characters may not be displayed correctly with this device, depending on the character type.
- The CD changer must also be CD Text compatible for the Text information to be displayed.
- When the Scroll Setting (page 32) is set to "MANUAL," press and hold **TITLE** for at least 2 seconds to scroll the Text information only once (TEXT DISPLAY, FOLDER NAME DISPLAY, FILE NAME DISPLAY or TAG DISPLAY mode).
- "NO SUPPORT" is displayed when the desired text information cannot be displayed on this unit.
- If the title was not previously input, "NO TITLE" is displayed.
- The text or tag information may not be correctly displayed, depending on the contents.
- Elapsed time is displayed for 5 seconds in the CD/MP3/WMA mode immediately after changing sources, songs, etc. (CDA-9853R only).

About the indicator display (CDA-9853R only)

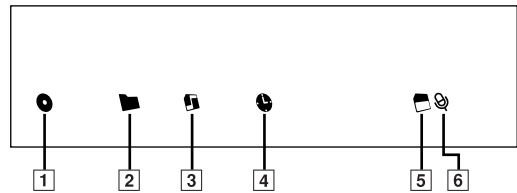

- 1 This indicator is lit when an album name is displayed.
- 2 This indicator is lit when a folder name is displayed.
- 3 This indicator is lit when a file name is displayed.
- 4 This indicator is lit when the elapsed playback time is displayed below.
- 5 This indicator is lit when the bit rate and sampling rate are displayed.
- 6 This indicator is lit when an artist name is displayed.

Titling Discs/Stations

It is possible to title your favourite CD's or radio stations.
You cannot input titles on MP3/WMA discs.

- 1 **Press TITLE and select the Title Display.**
For details, see asterisk 1 of "Displaying the Title/Text" (page 24).
- 2 **Press and hold TITLE for at least 2 seconds. The first character will blink.**
- 3 **Press BAND to select the characters/symbols.**
Upper case → Lower case → Numeral/Symbol* → Upper case
* Press **◀◀** or **▶▶** to change pages. (CDA-9855R only)
- 4 **Turn the Rotary encoder to select the desired letter/numeral/symbol available for naming.**
- 5 **Press Rotary encoder to store the first character.**
The first character will stop blinking and the display will automatically advance to the next character. When that character begins to blink, you may choose the next letter or symbol of your title.

• **If you want to correct a title (CDA-9855R only):**
In the title input mode, press SOURCE/POWER, and move the cursor to the title you have input. Turn the Rotary encoder to move the cursor to the title part to be changed. Press SOURCE/POWER again to return to the title input mode for any further editing.
- 6 **Repeat steps 3 and 5 above to complete the titling.**
Pressing the Rotary encoder after entering the 8th character (the maximum number of characters that can be input for CDA-9855R is 16) automatically stores the title into memory.

When entering a title of less than 8 or 16 characters (for example, 3 character title):
After entering 3 characters, the 4th character space will be blinking. Go to step 7 to complete the title.

Continued

7 Press **TITLE** to record the title.

- If you cancel while entering a title, selected characters are not written.
- You can enter 18 radio station titles (24 for the CDA-9853R model) and 18 CD titles on this unit. If you try to store beyond the limit, the display will show "FULL DATA." At this point, no more titles can be stored. To input a new title, one of the previously inputted titles must first be deleted.
- The CD Changer title length or memory capacity varies depending upon the model being used.
- When you want to erase a title, enter a space (and symbol " " for the CDA-9853R model).
- The operations described in steps 3 to 6 must be made within 10 seconds. The input mode will be cancelled if no action is taken for over 10 seconds.

Erasing Disc Title/Station Title

1 Press **TITLE** to select the Title Display. Then, press again and hold for at least 2 seconds.

- For details, see asterisk 1 of "Displaying the Title/Text" (page 24).

2 Within 10 seconds, press and hold **▶/II** for at least 2 seconds.

The title in the display will blink.

3 Within 10 seconds, press **◀◀** or **▶▶** repeatedly until the title you want to erase is displayed.

4 Within 10 seconds, press and hold **▶/II** for at least 2 seconds to erase the title displayed.

5 Press **TITLE** to cancel the title erasing mode.

- You cannot erase CD-TEXT.
- "TITLE NO DATA" ("NO DATA") is displayed for 2 seconds if the title is not input in step 2, or all titles are erased in step 4.

Blackout Mode On and Off (CDA-9855R only)

When Blackout mode is turned on, the display will turn off to reduce power consumption.

This additional power enhances the sound quality.

Press and hold **FUNC.** for at least 2 seconds to activate the blackout mode.

The display will turn off.

- If any button on the unit is pressed during the blackout mode, the function will be displayed for 5 seconds to show the operation before returning to Blackout mode.

To cancel Blackout mode, press and hold **FUNC.** for at least 2 seconds.

Setting Amplifier Link

When an Amplifier Link compatible amplifier (MRD-M1005 or MRD-M605, etc.) is connected, the amplifier settings are adjustable from the head unit. A maximum of 8 amplifiers can be adjusted.

1 Press and hold **MENU** for at least 2 seconds.

2 Select the Amplifier Link (A-LINK) mode by sliding your finger on the **GlideTouch bar** to the left or right. Press the **GlideTouch bar** under the Amplifier Link (A-LINK) mode.

3 Select the AMP-ID (AMP-1 to AMP-8) to be adjusted by sliding your finger on the **GlideTouch bar** to the left or right. Press the **GlideTouch bar** under the desired AMP-ID.

The input level mode to be adjusted is activated.

If a Mono Amplifier is Connected

4 Adjust the input level by sliding your finger on the **GlideTouch bar** to the left or right. Press the **GlideTouch bar** under the desired level.

If a 4ch Amplifier is Connected

4 Adjust the input level of CH 1/2 by sliding your finger on the **GlideTouch bar** to the left or right. Press the **GlideTouch bar** under the desired level.

5 Adjust the input level of CH 3/4 by sliding your finger on the **GlideTouch bar** to the left or right. Press the **GlideTouch bar** under the desired level.

6 When adjustment has been completed, press and hold **MENU** for at least 2 seconds to return to normal mode.

- For details of each of the settings, refer to the Owner's Manual of the external amplifier.
- If amplifier settings are made on the unit, do not then change the setting with the amplifier buttons as the amplifier display may not match the operations of the unit.
- "No Link" is displayed if the amplifier is removed or its power cannot be turned on, etc.
- If multiple amplifiers are connected to this unit, set a different ID on each amplifier. Otherwise the display may flicker.
- External amplifier information display can be changed by pressing **TITLE** while adjusting the input level.
- If the **GlideTouch bar** is pressed and held while adjusting the input level, the amplifier link mode can be switched between lock and unlock.
- If **MENU** is pressed while adjusting or setting items in the **MENU** mode, the unit will return to the previous selection screen.
- By pressing the **GlideTouch bar** under **RETURN** in the **MENU** mode, the unit returns to the normal mode.
- If no operation is performed for 60 seconds, the unit returns to normal mode.

Displaying the External Amplifier Information

When an Amplifier Link compatible amplifier is connected, the amplifier's status (voltage, temperature, fan status) can be shown in the head unit's display.

Press **TITLE** in the Radio or CD mode to switch the display of the external amplifier information.

- For switching the display, refer to the section "Displaying the Title/Text" (page 24).
- For changing the iPod display, refer to the section "Displaying the Text" (page 34).

CDA-9855R

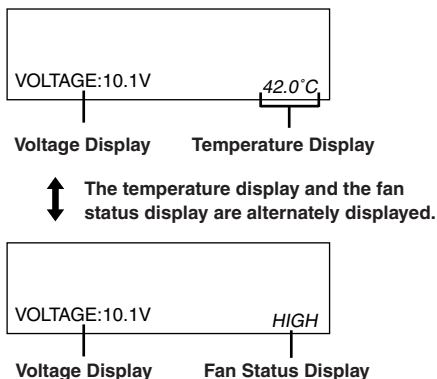

CDA-9853R

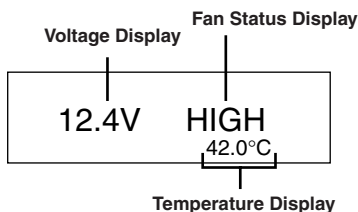

- To switch the display between Celsius and Fahrenheit, refer to page 32.

Setting the Multicolour Illumination

You can change the lighting colour of the following four buttons : SOURCE/POWER, BAND, ◀◀ and ▶▶.

- 1 Press **MENU**.
- 2 Select the Multicolor mode by sliding your finger on the **GlideTouch** bar to the left or right. Press the **GlideTouch** bar under the Multicolor mode.
- 3 Change the colour by sliding your finger on the **GlideTouch** bar to the left or right. Press the **GlideTouch** bar under the desired colour.

BLUE ↔ GREEN ↔ AMBER ↔ RED ↔ (USER'S*)

- * You can also use other colours if they have already been stored in the USER'S presets described below.
- According to the lighting colour of the above four buttons, the colour of the other buttons also changes. When the colour of the four buttons is BLUE/AMBER/RED, the colour of the others is RED. When the colour of the four buttons is GREEN, the others are also GREEN. (CDA-9853R only.)

If you want to use colours other than the above

- 4 Turn the **Rotary encoder** to select colours (1 through 512).
Each press of BAND advances the colour number by 30.
1.....19.....184.....363.....512
(Red) (Amber) (Green) (Blue)
- 5 Select any one of the preset numbers (1 through 6) by sliding your finger on the **GlideTouch** bar to the left or right. Press the **GlideTouch** bar under the desired preset to store the adjustment.

To recall the stored colour setting

- 1 Select USER'S (1 through 6) in step 3.
The stored setting contents are recalled.

- 6 When adjustment has been completed, press and hold **MENU** for at least 2 seconds to return to normal mode.

- If **MENU** is pressed while adjusting or setting items in the MENU mode, the unit will return to the previous selection screen.
- By pressing the **GlideTouch** bar under RETURN in the MENU mode, the unit returns to the normal mode.
- If no operation is performed for 60 seconds, the unit returns to normal mode.

Changing the Lighting Colour of All the Buttons

You can change the lighting colour of the unit.

- 1 Press **MENU**.
- 2 Select the Multicolor mode by sliding your finger on the **GlideTouch** bar to the left or right. Press the **GlideTouch** bar under the Multicolor mode.
- 3 Press **SOURCE/POWER**.
The lighting colour of all the buttons are changed.
- 4 After setting, press and hold **MENU** for at least 2 seconds to return to normal mode.

CDA-9855R:
WHITE ↔ RED

CDA-9853R:
RED ↔ GREEN

- SOURCE/POWER, BAND, ◀◀ and ▶▶ buttons are changed to that which you have set above in "Setting Multicolour Illumination" (this page).
- If **MENU** is pressed while adjusting or setting items in the MENU mode, the unit will return to the previous selection screen.
- By pressing the **GlideTouch** bar under RETURN in the MENU mode, the unit returns to the normal mode.

i-Personalize™ Operation

SOURCE/POWER

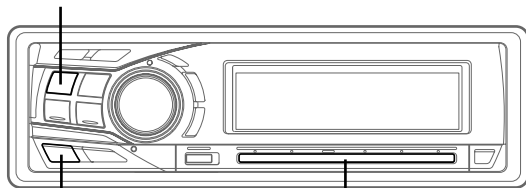

MENU

GlideTouch bar

About i-Personalize™

You can download data (from Alpine's website) to a CD-R, and download and store the data to the CDA-9855R/CDA-9853R.

To start i-Personalize, access the URL below and follow the on-screen instructions.

<http://www.alpine.com> or <http://www.alpine-europe.com>
or <http://www.alpine.com.au>

Downloadable data

Parametric equalizer or Graphic equalizer	Data is memorized in Preset 6 of the Parametric EQ Mode or Graphic EQ mode.
Time correction	Data is memorized in Preset 6 of the Time Correction Mode.
Crossover	Data is memorized in Preset 6 of the crossover mode.

The file name of download data shall be
"A_U*****.MP3."

A_U*****.MP3

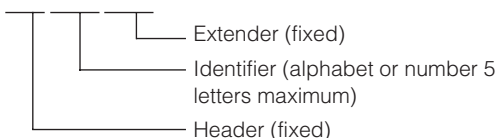

You can create a file name via the website. Do not change a file name once it has been created. Malfunction may result.

- For downloading procedure details, see ALPINE's Web site.
- If the HDA-5460 model is connected to this unit, the HDA-5460 hard disc can be used. Data that has been stored in the hard disc is downloaded by the "Data Downloading" operation to CDA-9855R/CDA-9853R. The hard disc drive (HDD) can be selected by switching the source in step 1. For details on how to download data to the hard disc, refer to the Owner's Manual of the HDA-5460 model.
- If an external audio processor is connected, data that is downloaded cannot be used.

Data Downloading

- 1 Insert the CD-R disc containing the data.
If the source is not the CD mode, press **SOURCE/POWER** to change to CD mode.
- 2 Press **MENU**.
- 3 Select the Download mode by sliding your finger on the **GlideTouch bar** to the left or right. Press the **GlideTouch bar** under the Download mode.
- 4 Select Download (YES) by pressing the **GlideTouch bar** under Download (YES).
Data search of the disc starts and the first file name is displayed.

- If you want to cancel the data search, press the **GlideTouch bar** under CANCEL (NO).
- If a file is not found by a data search, "NO FILE" is indicated.
- The "NO FILE" display will automatically disappear if no operation is performed for 5 seconds.

- 5 Select the file to download by sliding your finger on the **GlideTouch bar** to the left or right. Press the **GlideTouch bar** under the desired file.
Data downloading starts.

- 6 When data download is finished successfully, the confirmation screen is displayed (for the CDA-9853R model, each confirmation screen of download data is sequentially displayed), and download finishes.

Successfully downloaded items are indicated as checked boxes on the confirmation screen.

PARAMETRIC EQ or GRAPHIC EQ data*

The data is memorized in Preset 6 of Parametric EQ mode or Graphic EQ mode. The memorized data settings in Preset 6 (Parametric EQ mode or Graphic EQ mode) are automatically applied.

X-OVER (Crossover) data

The data is memorized in Preset 6 of X-OVER mode. The memorized data settings in Preset 6 (X-OVER mode) are automatically applied.
You cannot download the data if the setting of the 2WAY/3WAY switch is not suitable for the data.

TIME CORRECTION data

The data is memorized in Preset 6 of the Time correction mode. The memorized data settings in Preset 6 (Time Correction mode) are automatically applied.

- * If the downloaded parametric EQ or graphic EQ differs from the current EQ mode, Preset 6 setting will not change automatically. Change the EQ mode and recall Preset 6.
- * If data is downloaded while setting DEFEAT to ON, Preset 6 setting will not change automatically. Recall Preset 6 in the EQ mode.

- 7 Press and hold **MENU** for at least 2 seconds to return to normal mode.

- When you download the data again, the data is overwritten in Preset 6.
- If **MENU** is pressed while adjusting or setting items in the MENU mode, the unit will return to the previous selection screen.
- By pressing the **GlideTouch bar** under RETURN in the MENU mode, the unit returns to the normal mode.

SETUP

You can flexibly customize the unit to suit your own preferences and usage. From the SETUP menu, choose from Sound Customizing, Visual Customizing, etc., to make your desired setting.

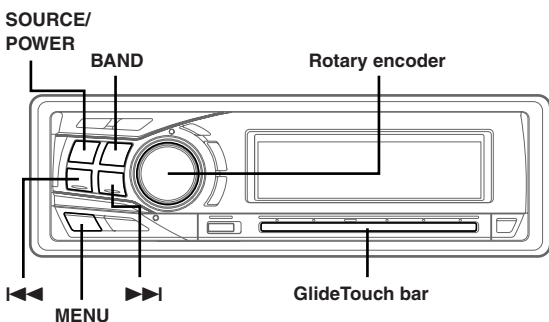

A typical SETUP procedure is shown in steps 1 to 4 as follows. See below for further information about each SETUP menu.

- 1 Press MENU.**
- 2 Select SETUP by sliding your finger on the GlideTouch bar to the left or right. Press the GlideTouch bar under SETUP.**
The main SETUP menu is displayed.
- 3 Select the desired item by sliding your finger on the GlideTouch bar to the left or right. Press the GlideTouch bar under your selection.**
GENERAL ↔ TUNER ↔ AUDIO ↔ DISPLAY ↔ DEMO
The SETUP menu of the selected item is displayed.
- 4 Select the desired item by sliding your finger on the GlideTouch bar to the left or right. Press the GlideTouch bar under your selection.**

CDA-9855R: GENERAL

PLAY MODE ↔ BEEP ↔ INT MUTE ↔ INT AUDIO ↔ AUX IN ↔ (AUX NAME)^{*1} ↔ D-AUX ↔ POWER-IC ↔ STEERING ↔ PLAY MODE

TUNER

FM LEVEL ↔ RDS REGIONAL^{*2} ↔ PI SEEK^{*3} ↔ TUNER MODE ↔ FM LEVEL

AUDIO

SUBWOOFER ↔ SUBW CH ↔ SUBW SYSTEM^{*4} ↔ EQ MODE^{*5} ↔ TW SETUP^{*6} ↔ A.PROC TYPE ↔ SUBWOOFER

DISP

DIMMER ↔ DIMMER LEVEL ↔ SCROLL TYPE ↔ TEXT SCROLL ↔ FONT SELECT ↔ A-LINK TEMP^{*7} ↔ BGV SELECT ↔ T.CORR^{*8} ↔ DIMMER

DEMO

DEMO

CDA-9853R:

GENERAL

PLAY MODE ↔ BEEP ↔ INT MUTE ↔ INT AUDIO ↔ AUX IN ↔ (AUX NAME)^{*1} ↔ D-AUX ↔ POWER-IC ↔ STEERING

TUNER

FM LEVEL ↔ RDS REGIONAL^{*2} ↔ PI SEEK^{*3} ↔ TUNER MODE

AUDIO

SUBWOOFER ↔ SUBW CH ↔ SUBW SYSTEM^{*4} ↔ EQ MODE^{*5} ↔ TW SETUP^{*6} ↔ AP SELECT

DISPLAY

DIMMER ↔ DIMMER LEV ↔ SCROLL TYPE ↔ TEXT SCROLL ↔ LCD CONTRAST ↔ A-LINK TEMP^{*7} ↔ AUDIO LEVEL ↔ T.CORR PAR^{*8}

DEMO

DEMO

^{*1} Displayed only when AUX is ON.

^{*2} Refer to "Receiving RDS Regional (Local) Stations" (page 10).

^{*3} Refer to "PI SEEK Setting" (page 11).

^{*4} Displayed only when SUBWOOFER is ON.

^{*5} Refer to "Setting User's EQ mode" (page 17).

^{*6} Displayed only when the 2WAY/3WAY switch (pages 42 to 44) is set to 3WAY. This function cannot be selected when an external audio processor is connected.

^{*7} "A-LINK TEMP" is displayed when an Amplifier Link compatible external amplifier is connected.

^{*8} Refer to "Setting the Time Correction Unit" (page 22).

- 5 Change the parameter by pressing the GlideTouch bar under the setting desired.**

- 6 After setting, press and hold MENU for at least 2 seconds to return to normal mode.**

- If MENU is pressed while adjusting or setting items in the MENU mode, the unit will return to the previous selection screen.
- By pressing the GlideTouch bar under RETURN in the MENU mode, the unit returns to the normal mode.
- If no operation is performed for 60 seconds, the unit returns to normal mode.

General Setting

General is selected on the setup main menu in step 3.

Playing MP3/WMA Data (PLAY MODE)

CDA-9855R:

CD-DA (Initial setting) / CDDA&MP3/WMA

CDA-9853R:

CDDA (Initial setting) / CDDA&MP3/WMA

This product can playback CDs containing both CD and MP3/WMA data. However, in some situations (some enhanced CDs), playback may be difficult. For these special cases, you can select playback of CD data only. When a disc contains both CD or the MP3/WMA data, playback starts from the CD data portion of the disc.

CDDA : Only CD data can be played back.
CDDA&MP3/WMA : Both CD data and MP3/WMA file tracks can be played back.

- Perform this setting before inserting a disc. If a disc has already been inserted, perform the setting after you remove the disc. (If you use an MP3 changer, you have to change discs.)

Sound (Beep) Guide Function

BEEP ON (Initial setting) / BEEP OFF

This function will give audible feedback with varying tones depending upon the button pressed.

Continued

Turning Mute Mode On/Off

INT MUTE ON (Initial setting) / INT MUTE OFF

If a device having the interrupt feature is connected, audio will be automatically muted whenever the interrupt signal is received from the device.

Setting the External Digital Input

D-AUX ON / D-AUX OFF (Initial setting)

When an ALPINE Ai-NET compatible digital audio processor and a DVD player (DVE-5207) not compatible with Ai-NET are connected, set D-AUX to ON to enjoy 5.1-channel surround sound.

- After setting D-AUX to ON, make the setting in "Connecting an Optical Digital Compatible Audio Processor and an Ai-NET Non-Compatible DVD Player."
- Press **SOURCE/POWER**, and select the D-AUX mode, and adjust the volume, etc.
- Depending on the connected audio processor, DVD player sound may continue to be output, even though the source is changed to another one. If this occurs, set the DVD player's power to OFF.

Setting Tone Defeat for External Devices

INT AUDIO ON / INT AUDIO OFF (Initial setting)

When inputting external devices to this unit, turning tone defeat on will bypass EQ and MX, etc. Audio for external devices is output at the default setting.

Setting the AUX Mode (V-Link)

AUX IN ON / AUX IN OFF (Initial setting)

You can input TV/video sound by connecting an optional Ai-NET/RCA Interface cable (KCA-121B) or Versatile Link Terminal (KCA-410C) to this component.

You can change the AUX name display when AUX ON is set. Select the AUX name by sliding your finger on the **GlideTouch bar** to the left or right. Then press the **GlideTouch bar**.

If the KCA-410C is connected, it is possible to select two AUX names.

- Via KCA-410C, up to 2 external devices with RCA output can be connected. In this case, press **SOURCE/POWER** to select AUX mode and then press **BAND** to select your desired device.

Connecting to an External Amplifier

POWER-IC ON (Initial setting) / POWER-IC OFF

When an external amplifier is connected, sound quality can be improved by stopping the power supply of the built-in amplifier.

POWER-IC OFF : Use this mode when the front and rear pre-amplifier of the unit are used to drive an external amplifier connected to the speakers. In this setting, the head unit's internal amplifier has no output to drive speakers.

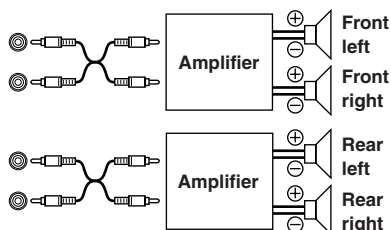

POWER-IC ON : The speakers are driven by the built-in amplifier.

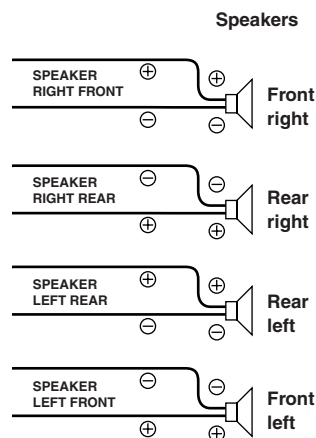

- No sound is produced by the system when the power output is set to OFF.

Setting the Steering Position

STEERING RIGHT / STEERING LEFT (Initial setting)

According to the car's steering position, set to left or right.

- LEFT** : Set to LEFT for left-hand drive. The right switch has priority when two switches on the **GlideTouch bar** are pressed.
- RIGHT** : Set to RIGHT for right-hand drive. The left switch has priority when two switches on the **GlideTouch bar** are pressed."

Tuner Setting

Tuner is selected on the setup main menu in step 3.

Adjusting Source Signal Levels

FM LEVEL HIGH (Initial setting) / FM LEVEL LOW

If the difference in volume level between the CD player and FM radio is too great, adjust the FM signal level.

Switching the Tuner Mode

CDA-9855R:

STABLE/NORMAL (Initial setting) / HiFi

CDA-9853R:

STABLE/NORMAL (Initial setting) / HI-FI

This unit incorporates the MAX TUNE PRO for the highest quality tuner audio. Moreover, you can choose between three settings to suit your own personal sound preferences and usage.

- NORMAL** : Standard setting
- HI-FI** : Sound quality priority setting
- STABLE** : Noiseless priority setting

- If you find the sound is very noisy while listening to the tuner in Hi-Fi mode, we recommend you change to Normal mode.

Audio Setting

Audio is selected on the setup main menu in step 3.

Subwoofer On and Off

SUBWOOFER ON (Initial setting) / SUBWOOFER OFF

When the subwoofer is on, perform the steps below to adjust the subwoofer output phase and level.

- 1 Press the **Rotary encoder** repeatedly to select the SUBWOOFER mode.

SUBWOOFER → BALANCE → FADER → DEFEAT → VOLUME → SUBWOOFER

- If you set the 2WAY/3WAY switch (pages 42 to 44) to 3WAY, you cannot adjust the FADER mode.

- 2 Press **◀▶** or **▶▶**.

The subwoofer output phase is toggled SUBWOOFER NORMAL (0°) or SUBWOOFER REVERS (180°). To adjust the level, turn the Rotary encoder.

Setting the Subwoofer Output

CDA-9855R:

SUBW CH ST (Initial setting) / MONO

CDA-9853R:

SUBW CH STEREO (Initial setting) / MONO

You can set the subwoofer output to stereo or monaural. Make sure to set the correct output for your subwoofer type.

STEREO : Subwoofer stereo (L/R) output
MONO : Subwoofer monaural output

Setting the Subwoofer System

CDA-9855R:

SUBW SYS1 (Initial setting) / SUBW SYS2

CDA-9853R:

SUBW SYSTEM1 (Initial setting) / SUBW SYSTEM2

Select either SYSTEM1 or SYSTEM2 for the desired subwoofer effect.

SYSTEM1 : Subwoofer level changes according the main volume setting.

SYSTEM2 : Subwoofer level change is different from the main volume setting. For example, even at low volume settings, the subwoofer is still audible.

Setting the Response Slope for the High Range Speaker (TW SETUP)

MAKER'S (Initial setting) / USER'S

Depending on the response characteristics of the speaker, care should be taken when setting the response slope of the high range speaker to FLAT in 3-way mode (see "Adjusting and Storing the Crossover Settings" on page 20), as speaker damage may result.

MAKER'S : As protection from possible speaker damage, FLAT cannot be set for the response slope of the high range speaker in 3-way mode.

USER'S : The FLAT setting is possible in 3-way mode.

- A message is displayed when the response slope for the high range speaker is set to FLAT in 3-way mode (CDA-9855R only).

Connecting an Optical Digital Compatible Audio Processor and an Ai-NET Non-Compatible DVD Player H510 / OTHER (Initial setting)

After setting D-AUX to ON in "Setting the External Digital Input," do the following according to the audio processor type:

H510 : If a PXA-H510 and a DVD player (DVE-5207) not compatible with Ai-NET are connected (using an optical cable), use the H510 setting. Connect the DVD player to the optical digital input (DVD Player) terminal of the processor.

OTHER : If an audio processor other than a PXA-H510 and a DVD player (DVE-5207) not compatible with Ai-NET are connected (using an optical cable), use the OTHER setting. Connect the DVD player to the optical digital input (Head unit) terminal of the processor.

- After input selection is completed, turn the ignition off and back on again. Setting of the optical digital input switch is completed.

Display Setting

The display is selected on the setup main menu in step 3.

Dimmer Control

DIMMER AUTO (Initial setting) / DIMMER MANUAL

Set the DIMMER control to AUTO to decrease the illumination brightness of the unit with the head lights of the vehicle ON. This mode is useful if you feel the unit's button lighting is too bright at night.

- If your vehicle has a dimmer control for the speedmetre area, do not connect the DIMMER cable (orange) of the radio to this dimmer control.

Setting the Display Dimmer

CDA-9855R:

DIMMER Level1 (initial setting) / Level2 / Level3

CDA-9853R:

DIMMER LEV1 (initial setting) / 2 / 3

In the display Dimmer AUTO setting, three levels are available, the highest level (LEVEL 3) being the dimmest when the car headlights are on.

Scroll Type Setting

TYPE1 / TYPE2 (Initial setting)

Two types of scroll can be selected. You can select the scroll type you like.

TYPE1 : The characters scroll right to left, appearing from the right side of the display, one character at a time.

TYPE2 : The display will show complete words, unless they do not fit in the display at one time. Words hyphenated when necessary and are shown sequentially until the full title has been displayed.

Scroll Setting

AUTO / MANUAL (Initial setting)

This CD player can scroll the disc and track names recorded on CD-TEXT discs, as well as the text information of MP3/WMA files, folder names, and tags.

- AUTO :** The CD text information, the text information of folder and file names, and the tags are scrolled automatically.
 - MANUAL :** The display is scrolled when a disc is loaded or when a track is changed, etc.
- *The unit scrolls CD text names, folder names, file names or tag display. The disc titles input manually (page 25) cannot be scrolled.*

Adjusting Display Contrast (CDA-9853R only)

CONTRAST

You can adjust the display contrast for better visibility.

- You can adjust in a range of - 6 and + 6.
- *The initial setting at the factory is "0."*

Switching the Character Font (CDA-9855R only)

TYPE1 (Initial setting) / TYPE2

Two types of font can be selected.

You can select the font type you like.

Setting the Temperature Display for the External Amplifier

CDA-9855R:

A LINK F / A LINK C (Initial setting)

CDA-9853R:

AMP TEMP °F / AMP TEMP °C (Initial setting)

When a separately sold Amplifier Link compatible amplifier is connected, you can set how to display its temperature. You can switch the setting between Fahrenheit and Celsius.

- °F : The temperature is displayed in Fahrenheit.
- °C : The temperature is displayed in Celsius.

Setting the Display of the Audio Level Indicator (CDA-9853R only)

AUDIO LV ON (initial setting) / AUDIO LV OFF

You can set whether the audio level indicator is displayed.

Switching the Animation Display Type (CDA-9855R only)

TYPE1 (initial setting) / TYPE2 / TYPE3 / OFF

When the animation display is set in "Displaying the Title/Text" (page 24), you can select your favourite animation display from 3 types.

Demo Setting

Demo is selected on the setup main menu in step 3.

Demonstration

DEMO ON / DEMO OFF (Initial setting)

This unit has a Demonstration feature for the display and sound.

- *To quit Demo mode, set to DEMO OFF.*

iPod™ Operation (Optional)

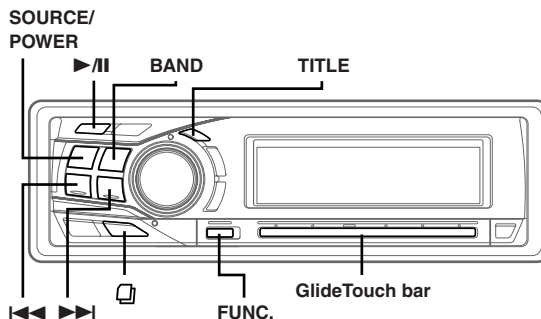

When an iPod™ or iPod™ mini is connected to the optional Alpine Interface adapter for iPod™ (KCA-420i), it can be controlled from the CDA-9855R/CDA-9853R. However, operation from the iPod is disabled.

- *For details, refer to the Owner's Manual of the iPod™ Interface adapter (KCA-420i).*
- *Refer to the iPod's documentation for a description of its functions.*

Playback

1 Press **SOURCE/POWER** to switch to the iPod mode.

2 Press **◀◀** or **▶▶** to select the desired song.

Return to the beginning of the current song:

Press **◀◀**.

Fast backward:

Press and hold **◀◀**.

Advance to the beginning of the next song:

Press **▶▶**.

Fast forward:

Press and hold **▶▶**.

3 To pause playback, press **▶/||**.

Pressing **▶/||** again will resume playback.

- *If a song is playing on the iPod when it is connected to the adapter, it will continue playing after the connection.*
- *If using the iPod with a changer, the Versatile Link Terminal (KCA-410C) must be used. In this case, press **BAND** to select the changer mode applicable to the iPod.*
- *With the CDA-9855R, you can return to the beginning of the current track, fast forward/fast reverse and playback/pause. The source operation mode is selected by touching the **GlideTouch bar** under **FUNC.** in the function guide display.*

Searching for a desired Song

An iPod can contain hundreds of songs. By keeping these songs organized in playlists, the CDA-9855R/CDA-9853R can use these to ease song searches.

- *When Shuffle (M.I.X.) is on, the search function cannot be used.*

Searching by Playlist

- 1 Press .
- 2 Select **PLAYLIST** by sliding your finger on the **GlideTouch bar** to the left or right. Press the **GlideTouch bar** under **PLAYLIST**.
- 3*¹ Within 10 seconds, select a playlist by sliding your finger on the **GlideTouch bar** to the left or right.
- 4 Within 10 seconds, press **▶/||** to play back a selected playlist.

To search for a song in the selected playlist

- 1 After selecting the playlist in step 3*¹, press the **GlideTouch bar** or **FUNC.** to change to the song search mode of the selected playlist.
 - 2 Within 10 seconds, select a song by sliding your finger on the **GlideTouch bar** to the left or right, then press **▶/||** or the **GlideTouch bar**.
The selected song is played back.
- If you choose “iPod name” of iPod in step 3*¹ and you press **▶/||**, all songs in iPod are played back.
 - The search mode is cancelled by pressing and holding  for at least 2 seconds in the search mode.
 - The playlist can be scrolled continuously by touching and holding either side of the **GlideTouch bar**.
 - You can speed up your search by sliding your finger quickly on the **GlideTouch bar** to skip playlists.

Searching by artist name

- 1 Press .
- 2 Select **ARTIST** by sliding your finger on the **GlideTouch bar** to the left or right. Press the **GlideTouch bar** under **ARTIST**.
- 3*² Within 10 seconds, select the artist to be played back by sliding your finger on the **GlideTouch bar** to the left or right.
- 4 Within 10 seconds, press **▶/||** to play back all songs of the selected artist.

To search for an album of the selected artist

- 1 After selecting the artist in step 3*², press the **GlideTouch bar** or **FUNC.** to change to the album search mode of the selected artist.
- 2*³ Within 10 seconds, select the album to be played back by sliding your finger on the **GlideTouch bar** to the left or right.
- 3 Press **▶/||** to play back all songs of the selected album.

To search for a song of the selected album

- 1 After selecting the album in step 2*³, press the **GlideTouch bar** or **FUNC.** to change to the song search mode of the selected album.
- 2 Within 10 seconds, select a song by sliding your finger on the **GlideTouch bar** to the left or right, then press **▶/||** or the **GlideTouch bar**.
The selected song is played back.

- If you choose **ALL** in step 3*², and you press **▶/||**, all songs in iPod are played back. If you choose **ALL**, and you press the **GlideTouch bar** or **FUNC.**, the **ALBUM** search mode for all artists is activated.
- If you choose **ALL** in step 2*³, and you press **▶/||**, all songs of the selected artist are played back. If you choose **ALL**, and you press the **GlideTouch bar** or **FUNC.**, the **SONG** search mode for the selected artist is activated.
- The search mode is cancelled by pressing and holding  for at least 2 seconds in the search mode.
- The artist, album or song can be scrolled continuously by touching and holding either side of the **GlideTouch bar**.
- You can speed up your search by sliding your finger quickly on the **GlideTouch bar** to skip artists, albums or songs.

Searching by album name



- 1 Press .
- 2 Select **ALBUM** by sliding your finger on the **GlideTouch bar** to the left or right. Press the **GlideTouch bar** under **ALBUM**.
- 3*⁴ Within 10 seconds, select the album to be played back by sliding your finger on the **GlideTouch bar** to the left or right.
- 4 Within 10 seconds, Press **▶/||** to play back all songs of the selected album.

To search for a song of the selected album

- 1 After selecting the album in step 3*⁴, press the **GlideTouch bar** or **FUNC.** to change to the song search mode of the selected album.
 - 2 Within 10 seconds, select a song by sliding your finger on the **GlideTouch bar** to the left or right, then press **▶/||** or the **GlideTouch bar**.
The selected song is played back.
- If you choose **ALL** in step 3*⁴, and you press **▶/||**, the search mode is cancelled. If you choose **ALL**, and you press the **GlideTouch bar** or **FUNC.**, the **SONG** search mode for all albums is activated.
 - The search mode is cancelled by pressing and holding  for at least 2 seconds in the search mode.
 - The album or song can be scrolled continuously by touching and holding either side of the **GlideTouch bar**.
 - You can speed up your search by sliding your finger quickly on the **GlideTouch bar** to skip albums or songs.

Quick Search

You can search for songs.

- 1 Press and hold  for at least 2 seconds to activate the quick search mode.
 - 2 Select the desired song by sliding your finger on the **GlideTouch bar** to the left or right.
The selected song is played back immediately.
- The search mode is cancelled by pressing and holding  for at least 2 seconds in the search mode.
 - The songs can be scrolled continuously by touching and holding either side of the **GlideTouch bar**.
 - You can speed up your search by sliding your finger quickly on the **GlideTouch bar** to skip songs.
 - “Quick Search” (“**QUICK SEARCH**”) is displayed during Quick search.

Random Play Shuffle (M.I.X.)

The Shuffle function of the iPod is displayed as M.I.X. on the CDA-9855R/CDA-9853R.

Shuffle Albums (M.I.X. ALBUM):

Select an album randomly in the iPod, and plays back the songs of the album in sequential order. If a song has been selected in the playlist/artist search mode before selecting Shuffle Album, only the albums within the playlist/artist are selected randomly. The songs of the album are played back sequentially.

Shuffle Songs (M.I.X. ALL):

All songs in the iPod are played back in random sequence. If a song has been selected in the playlist/artist search mode before selecting Shuffle song, only the songs of the playlist/artist/album are played back randomly.

1 Press **FUNC.** to activate the audio function mode.

Source select mode → Audio function mode → Source operation mode* → Source select mode

* CDA-9855R only

2 Press the **GlideTouch** bar under the MIX function in the function guide display.

The songs will be played back in random sequence.



The Random Play mode is cancelled if off is selected.

- The function mode you previously recalled can be recalled again if the **GlideTouch** bar is touched.
- If no operation is performed for 10 seconds, the audio function mode turns off.
- For details of the search mode, refer to "Searching for a desired Song" (page 33).
- If a song is selected in the album search mode before selecting Shuffle (M.I.X.), the songs will not play back randomly even when Shuffle album is selected.
- If there is no album in the playlist, Shuffle (M.I.X.) will not function even when Shuffle album is selected.

Repeat Play

Only Repeat One is available for the iPod.

Repeat One: A single song is repeatedly played back.

1 Press **FUNC.** to activate the audio function mode.

Source select mode → Audio function mode → Source operation mode* → Source select mode

* CDA-9855R only

2 Press the **GlideTouch** bar under the RPT function in the function guide display.

The song will be played back repeatedly.

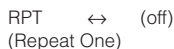

The RPT mode is cancelled if off is selected.

- The function mode you previously recalled can be recalled again if the **GlideTouch** bar is touched.
- If no operation is performed for 10 seconds, the audio function mode turns off.
- During repeat playback, no other songs are selectable by pressing ◀◀ or ▶▶.

Displaying the Text

You can display the tag information of a song in the iPod.

Press **TITLE.**

Each press changes the display.

CDA-9855R

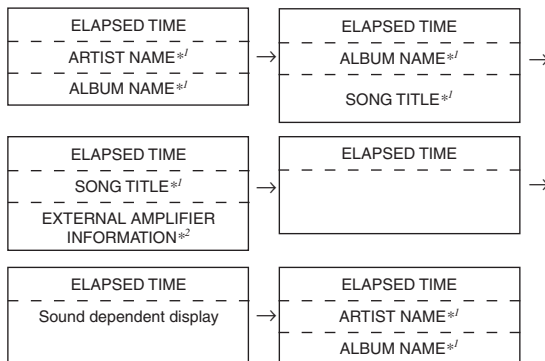

CDA-9853R

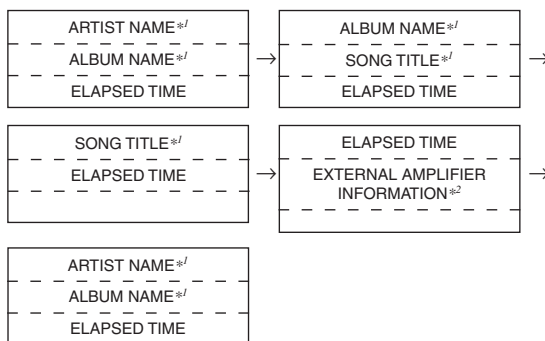

*1 "NO DATA" is displayed if there is no information.

*2 Only when an external Amplifier Link compatible amplifier is connected. For details, refer to "Displaying the External Amplifier Information" (page 27).

- When the Scroll Setting (page 32) is set to "MANUAL" press and hold **TITLE** for at least 2 seconds to scroll the tag information only once.
- Elapsed time is displayed for 5 seconds immediately after changing sources, songs, etc. (CDA-9853R only).
- Only alphanumeric characters can be displayed.
- When the artist name, album name or song name is set on iTunes, and the amount of characters is increased, songs may not be played back when connected to the adapter. Therefore, a maximum of 250 characters is recommended. The maximum number of characters for the head unit is 64.
- Some characters may not be correctly displayed.
- "NO SUPPORT" is displayed when text information is not compatible with the CDA-9855R/CDA-9853R.

Changer (Optional)

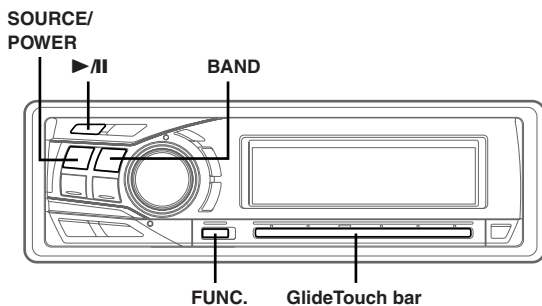

Controlling CD Changer (Optional)

An optional 6-disc or 12-disc CD Changer may be connected to this unit if it is Ai-NET compatible. With a CD Changer connected to the Ai-NET input of this unit, the CD Changer will be controllable from this unit.

Using the KCA-400C (Multi-Changer Switching device) or the KCA-410C (Versatile Link Terminal) multiple changers can be controlled by this unit.

See "Multi-Changer Selection" on this page for selecting the CD Changers.

- The controls on this unit for CD Changer operation are operative only when a CD Changer is connected.
- The DVD changer (optional) is controllable from this unit as well as the CD changer.

1 Press **SOURCE/POWER** to activate the **CHANGER** mode.

The display shows the disc number and track number.

- The source indicator varies depending on the connected source.

2 Press **FUNC.** to activate the **direct disc recall** mode.

Source select mode → Audio function mode → Direct disc recall mode → Source operation mode* → Source select mode

* CDA-9855R only

3 Select a disc (1 to 6) or (1 to 12) by touching the **GlideTouch bar** and sliding your finger to the left or right. Press the **GlideTouch bar** under the desired disc.

The selected disc number appears in the display and CD playback starts.

- After selecting the desired disc, you can operate in the same way as for the CD player of this unit.
For details, please see the CD/MP3/WMA section.

Playing MP3 Files with the CD Changer (Optional)

If you connect a changer compatible with MP3, you can play CD-ROMs, CD-Rs, and CD-RWs containing MP3 files on this unit.

1 Press **SOURCE/POWER** to switch to the **MP3 Changer** mode.

2 Press **FUNC.** to activate the **direct disc recall** mode.

Source select mode → Audio function mode → Direct disc recall mode → Source operation mode* → Source select mode

* CDA-9855R only

3 Select a disc (1 to 6) by touching the **GlideTouch bar** and sliding your finger to the left or right. Press the **GlideTouch bar** under the desired disc.

4 To pause playback, press **▶/II**.

Pressing **▶/II** again will resume playback.

- The unit can play discs containing both audio data and MP3 data.
- For operating MP3 with an MP3 compatible CD Changer, refer to "CD/MP3/WMA" pages 13 to 16.

Multi-Changer Selection (Optional)

Alpine's Ai-NET system will support up to 6 CD Changers. When operating two or more changers, the KCA-400C (Multi-Changer Switching device) must be used. If you use 1 Switching device, you can connect up to 4 CD Changers. If you use 2 Switching devices, you can connect up to 6 CD Changers. When using KCA-410C (Versatile Link Terminal), you can connect two changers and two external outputs (AUX).

1 Press **SOURCE/POWER** on this unit to activate the **CD Changer** mode.

Alternatively, press **SOURCE** on the remote control (RUE-4202) (CDA-9855R only) to activate the CD Changer mode.

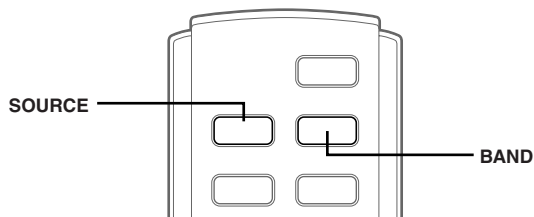

2 Press **BAND** on this unit or the **RUE-4202** to activate the **CD Changer Selection** mode.

The CD Changer Selection mode remains active for a few seconds.

3 Press **BAND** until the desired **CD Changer** indicator appears on the display.

Alternatively press **BAND** on the Remote Control (CDA-9855R only) until the desired changer indicator appears on the display.

- If the selected CD Changer is not connected, the display will show "NO CHGR."
- To operate the selected changer, see "CD/MP3/WMA" (page 13).
- For further details about the external input (AUX) when using KCA-410C, see "Setting the AUX Mode (V-Link)" on page 30.

Remote Control

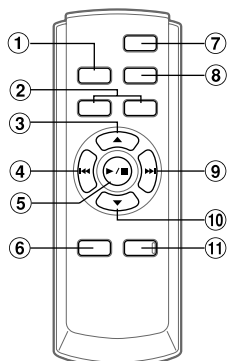

Controls on Remote Control (CDA-9855R only)

- ① **Source Button**
Press this button to select the audio source.
- ② **Volume Adjustment Buttons**
To increase the volume level:
Press the button

To decrease the volume level:
Press the button
- ③ **▲ Button**
Radio mode: Pressing this button will select, in ascending order, stations programmed into the radio's presets as shown below.

 → ... →

CD Changer mode: DISC Select (UP) button
Press this button to select a disc in ascending order.

MP3/WMA mode:
Press the Folder Select (UP) button to select the folder.
MP3 compatible CD changer mode:
Folder Select (UP) / DISC Select (UP) button
Press this button to select a folder in ascending order.
Press and hold this button to select a disc in ascending order.
- ④ **◀◀ DN Button**
Radio mode: SEEK (DN) Button
CD mode: Press this button to go back to the beginning of the current track.
- ⑤ **▶▶/II Button**
Press this button to switch between the Play and Pause modes for CD.
- ⑥ **Audio Processor Button**
Each press of the button changes the audio processor mode.
For details, refer to "Operating the Audio Processor" as shown below.
Press the button to call the external audio processor mode when the external audio processor is connected.*¹
- ⑦ **Power Button**
Press this button to turn the power on/off.

- ⑧ **Band Button**
Radio mode: BAND Button
Press this button and the band will change.

Changer mode: To switch the changer.
- ⑨ **▶▶| UP Button**
Radio mode: SEEK (UP) button
CD mode: Press this button to advance to the beginning of the next track.
- ⑩ **▼ Button**
Radio mode: Pressing this button will select, in descending order, stations programmed into the radio's presets as shown below.

 → ... →

CD Changer mode: DISC Select (DN) button
Press this button to select a disc in descending order.
MP3/WMA mode:
Press the Folder Select (DN) button to select the folder.
MP3 compatible CD changer mode:
Folder Select (DN) / DISC Select (DN) button
Press this button to select a folder in descending order.
Press and hold this button to select a disc in descending order.
- ⑪ **Mute Button**
Press this button to lower the volume by 20 dB instantly.
Press this button again to cancel.

*¹ For the operation of external audio processor, refer to the Owner's Manual of the external audio processor you purchased.

Operating the Audio Processor (CDA-9855R only)

- 1 **Press A.PROC to select the mode.**
Normal mode → EQ mode (Equalizer Presets) → Time Correction mode (Recalling the Stored Time Correction) → Crossover mode (Recalling the Stored Crossover) → Normal mode
- 2 **Press ▲ or ▼ to select the item.**
EQ mode:
Select from factory's EQ mode and USER'S 1 to 6.

Time Correction mode/Crossover mode:
Select from MEMORY 1 through 6.

Battery Replacement (CDA-9855R only)

Applicable battery: Use two "AAA" sized dry batteries or equivalent.

1 Opening the battery cover

Slide out the battery cover while firmly pressing in the direction of the arrow.

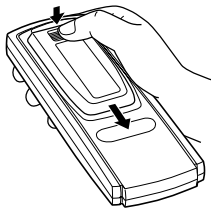

2 Replacing the battery

Insert the batteries, observing the polarities as illustrated.

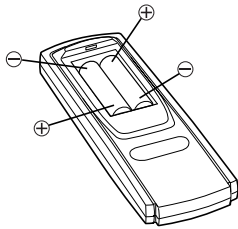

3 Closing the cover

Slide the cover as illustrated until a click is heard.

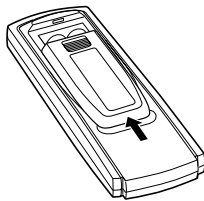

Controllable With Remote Control

The CDA-9853R can be controlled with an optional Alpine remote control. For details, consult your Alpine dealer. Point the optional remote control transmitter at the remote control sensor.

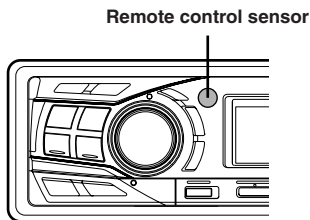

Connectable to Remote Control Interface Box

You can operate this unit from the vehicle's control unit when an Alpine Remote Control Interface Box (optional) is connected. For details, contact your Alpine dealer.

Information

In Case of Difficulty

If you encounter a problem, please turn the power off, then on again. If the unit is still not functioning normally, please review the items in the following checklist. This guide will help you isolate the problem if the unit is at fault. Otherwise, make sure the rest of your system is properly connected or consult your authorized Alpine dealer.

Basic

No function or display.

- Vehicle's ignition is off.
 - If connected following instructions, the unit will not operate with the vehicle's ignition off.
- Improper power lead (Red) and battery lead (Yellow) connections.
 - Check power lead and battery lead connections.
- Blown fuse.
 - Check the fuse of the unit; replace with the proper value if necessary.
- Internal micro-computer malfunctioned due to interference noise etc.
 - Press the RESET switch with a ballpoint pen or other pointed article.

Radio

Unable to receive stations.

- No antenna or open connection in cable.
 - Make sure the antenna is properly connected; replace the antenna or cable if necessary.

Unable to tune stations in the seek mode.

- You are in a weak signal area.
 - Make sure the tuner is in the DX mode.
- If the area you are in is a primary signal area, the antenna may not be grounded and connected properly.
 - Check your antenna connections; make sure the antenna is properly grounded at its mounting location.
- The antenna may not be the proper length.
 - Make sure the antenna is fully extended; if broken, replace the antenna with a new one.

Broadcast is noisy.

- The antenna is not the proper length.
 - Extend the antenna fully; replace it if it is broken.
- The antenna is poorly grounded.
 - Make sure the antenna is grounded properly at its mounting location.

CD

CD Player/Changer not functioning.

- Out of operating temperature range +50°C (+120°F) for CD.
 - Allow the vehicle's interior (or trunk) temperature to cool.

CD playback sound is wavering.

- Moisture condensation in the CD Module.
 - Allow enough time for the condensation to evaporate (about 1 hour).

Continued

CD insertion not possible.

- A CD is already in the CD player.
 - Eject the CD and remove it.
- The CD is being improperly inserted.
 - Make sure the CD is being inserted following instructions in the CD Player Operation section.

Unable to fast forward or backward the CD.

- The CD has been damaged.
 - Eject the CD and discard it; using a damaged CD in your unit can cause damage to the mechanism.

CD playback sound skips due to vibration.

- Improper mounting of the unit.
 - Securely re-mount the unit.
- The disc is very dirty.
 - Clean the disc.
- The disc has scratches.
 - Change the disc.
- The pick-up lens is dirty.
 - Do not use a commercial available lens cleaner disc. Consult your nearest ALPINE dealer.

CD playback sound skips without vibration.

- The disc is dirty or scratched.
 - Clean the disc; damaged disc should be replaced.

Error displays (built-in CD player only)

- Mechanical error
 - Press **▲**. After the error display disappears, insert the disc again. If the above-mentioned solution does not solve the problem, consult your nearest ALPINE dealer.

CD-R/CD-RW playback not possible

- Close session (finalization) has not been performed.
 - Perform finalization and attempt playback again.

MP3/WMA

MP3 or WMA is not played back.

- Writing error occurred. The CD format is not compatible.
 - Make sure the CD has been written in a supported format. Refer to "About MP3/WMA" (pages 15-16), then rewrite in the format supported by this device.

Audio

The sound is not output from the speakers.

- Unit has no output signal of the internal amplifier.
 - POWER-IC is switched to "ON" (page 30).

Indication for CD Player

High Temperature (CDA-9855R)

HIGH-TEMP (CDA-9853R)

- Protective circuit is activated due to high temperature.
 - The indicator will disappear when the temperature returns to within operation range.

No Disc (CDA-9855R)

NO DISC (CDA-9853R)

- No CD is inserted.
 - Insert a CD.
- Although a disc is inserted, "NO DISC" is displayed and the unit does not start to play or eject the disc.
 - Remove the disc by following these steps:
 - 1) Press the **▲** button.
The movable display will open.
 - 2) Press the **▲** button again for at least 2 seconds while the movable display is open.
If the disc still does not eject, consult your Alpine dealer.

Error (CDA-9855R)

ERROR (CDA-9853R)

- Mechanism error.
 - 1) Press the **▲** button and eject the CD.
If not ejecting, consult your Alpine dealer.
 - 2) When the error display remains after ejecting, press the **▲** button again.
If the error indication still does not turn off after pressing the **▲** button for a few times, consult your Alpine dealer.
- *When "ERROR" is displayed:*
*If the disc cannot be ejected by pressing **▲**, press the RESET switch (refer to page 7) and press **▲** again.*
If the disc still cannot be ejected, consult your Alpine dealer.

PROTECT

- A copy-protected WMA file was played back.
 - You can only play back non-copy-protected files.

UNSUPPORT

- The disc is not written in a MP3/WMA supported format.
 - Use a disc written in the MP3/WMA supported format.

Indication for CD Changer

High Temperature (CDA-9855R)

HIGH-TEMP (CDA-9853R)

- Protective circuit is activated due to high temperature.
 - The indicator will disappear when the temperature returns to within operation range.

Error 01 (CDA-9855R)

ERROR-01 (CDA-9853R)

- Malfunction in the CD Changer.
 - Consult your Alpine dealer. Press the magazine eject button and pull out the magazine.
Check the indication. Insert the magazine again.
If the magazine cannot be pulled out, consult your Alpine dealer.
- Magazine ejection not possible.
 - Press the magazine eject button. If the magazine does not eject, consult your Alpine dealer.

Error 02

(CDA-9855R)

ERROR-02

(CDA-9853R)

- A disc is left inside the CD Changer.
 - Press the eject button to activate the eject function. When the CD Changer finishes the eject function, insert an empty CD magazine into the CD Changer to receive the disc left inside the CD Changer.

No Magazine

(CDA-9855R)

NO MAGAZIN

(CDA-9853R)

- No magazine is loaded into the CD Changer.
 - Insert a magazine.

No Disc

(CDA-9855R)

NO DISC

(CDA-9853R)

- No indicated disc.
 - Choose another disc.

Indication for iPod Mode**NO IPOD**

- The iPod is not connected.
 - Make sure the iPod is correctly connected. Make sure the cable is not bent excessively.
- The iPod's battery remains low.
 - Refer to the iPod's documentation and charge the battery.

NO FILE

- There are no songs in the iPod.
 - Download songs to the iPod and connect to the CDA-9855R/ CDA-9853R.

Error 01

(CDA-9855R)

ERROR-01

(CDA-9853R)

- Communication error
 - Turn the ignition key off, and then set to ACC or ON again.
 - Check the display by reconnecting between the iPod and the adapter, using the iPod cable.

Error 02

(CDA-9855R)

ERROR-02

(CDA-9853R)

- Caused by the iPod Software Version not being compatible with the optional adapter KCA-420i.
 - Refer to the Owner's Manual of the optional adapter KCA-420i, and update the iPod Software Version to be compatible with the optional adapter KCA-420i.

Specifications**FM TUNER SECTION**

Tuning Range	87.5 – 108.0 MHz
Mono Usable Sensitivity	0.7 μV
Alternate Channel Selectivity	90 dB
Signal-to-Noise Ratio	65 dB
Stereo Separation	35 dB
Capture Ratio	2.0 dB

MW TUNER SECTION

Tuning Range	531 – 1,602 kHz
Sensitivity (IEC Standard)	25.1 μV/28 dB

LW TUNER SECTION

Tuning Range	153 – 281 kHz
Sensitivity (IEC Standard)	31.6 μV/30 dB

CD SECTION

Frequency Response	5 – 20,000 Hz (±1 dB)
Wow & Flutter (% WRMS)	Below measurable limits
Total Harmonic Distortion	0.008% (at 1 kHz)
Dynamic Range	95 dB (at 1 kHz)
Signal-to-Noise Ratio	105 dB
Channel Separation	85 dB (at 1 kHz)

PICKUP

Wave length	795 nm
Laser power	CLASS I

REMOTE CONTROL

Battery Type	“AAA” sized dry battery
Battery Quantity	2
Dimensions (W × H × D)	42 mm (1-21/32") × 121 mm (4-25/32") × 23 mm (29/32")
Weight (without battery)	50 g (1.8 oz)

GENERAL

Power Requirement	14.4 V DC (11–16 V allowable)
Power Output	50 W × 4
Maximum Pre-Output Voltage	4 V/10k ohms (CDA-9855R) 2V/10k ohms (CDA-9853R)
Weight	1.6 kg (3 lbs. 8 oz)

CHASSIS SIZE

Width	178 mm (7")
Height	50 mm (2")
Depth	160 mm (6-1/4")

NOSEPIECE SIZE

Width	170 mm (6-3/4")
Height	46 mm (1-13/16")
Depth	19 mm (3/4")

- Due to continuous product improvement, specifications and design are subject to change without notice.

CAUTION

**CLASS 1
LASER PRODUCT**

(Bottom side of player)

Installation and Connections

Before installing or connecting the unit, please read the following and pages 3 to 5 of this manual thoroughly for proper use.

Warning

MAKE THE CORRECT CONNECTIONS.

Failure to make the proper connections may result in fire or product damage.

USE ONLY IN CARS WITH A 12 VOLT NEGATIVE GROUND.

(Check with your dealer if you are not sure.) Failure to do so may result in fire, etc.

BEFORE WIRING, DISCONNECT THE CABLE FROM THE NEGATIVE BATTERY TERMINAL.

Failure to do so may result in electric shock or injury due to electrical shorts.

DO NOT SPLICE INTO ELECTRICAL CABLES.

Never cut away cable insulation to supply power to other equipment. Doing so will exceed the current carrying capacity of the wire and result in fire or electric shock.

DO NOT DAMAGE PIPE OR WIRING WHEN DRILLING HOLES.

When drilling holes in the chassis for installation, take precautions so as not to contact, damage or obstruct pipes, fuel lines, tanks or electrical wiring. Failure to take such precautions may result in fire.

DO NOT USE BOLTS OR NUTS IN THE BRAKE OR STEERING SYSTEMS TO MAKE GROUND CONNECTIONS.

Bolts or nuts used for the brake or steering systems (or any other safety-related system), or tanks should NEVER be used for installations or ground connections. Using such parts could disable control of the vehicle and cause fire etc.

KEEP SMALL OBJECTS SUCH AS BATTERIES OUT OF THE REACH OF CHILDREN.

Swallowing them may result in serious injury. If swallowed, consult a physician immediately.

DO NOT INSTALL IN LOCATIONS WHICH MIGHT HINDER VEHICLE OPERATION, SUCH AS THE STEERING WHEEL OR GEARSHIFT.

Doing so may obstruct forward vision or hamper movement etc. and results in serious accident.

Caution

HAVE THE WIRING AND INSTALLATION DONE BY EXPERTS.

The wiring and installation of this unit requires special technical skill and experience. To ensure safety, always contact the dealer where you purchased this product to have the work done.

USE SPECIFIED ACCESSORY PARTS AND INSTALL THEM SECURELY.

Be sure to use only the specified accessory parts. Use of other than designated parts may damage this unit internally or may not securely install the unit in place. This may cause parts to become loose resulting in hazards or product failure.

ARRANGE THE WIRING SO IT IS NOT CRIMPED OR PINCHED BY A SHARP METAL EDGE.

Route the cables and wiring away from moving parts (like the seat rails) or sharp or pointed edges. This will prevent crimping and damage to the wiring. If wiring passes through a hole in metal, use a rubber grommet to prevent the wire's insulation from being cut by the metal edge of the hole.

DO NOT INSTALL IN LOCATIONS WITH HIGH MOISTURE OR DUST.

Avoid installing the unit in locations with high incidence of moisture or dust. Moisture or dust that penetrates into this unit may result in product failure.

Precautions

- Be sure to disconnect the cable from the (-) battery post before installing your CDA-9855R/CDA-9853R. This will reduce any chance of damage to the unit in case of a short-circuit.
- Be sure to connect the colour coded leads according to the diagram. Incorrect connections may cause the unit to malfunction or damage to the vehicle's electrical system.
- When making connections to the vehicle's electrical system, be aware of the factory installed components (e.g. on-board computer). Do not tap into these leads to provide power for this unit. When connecting the CDA-9855R/CDA-9853R to the fuse box, make sure the fuse for the intended circuit of the CDA-9855R/CDA-9853R has the appropriate amperage. Failure to do so may result in damage to the unit and/or the vehicle. When in doubt, consult your ALPINE dealer.
- The CDA-9855R/CDA-9853R uses female RCA-type jacks for connection to other units (e.g. amplifier) having RCA connectors. You may need an adaptor to connect other units. If so, please contact your authorized ALPINE dealer for assistance.
- Be sure to connect the speaker (-) leads to the speaker (-) terminal. Never connect left and right channel speaker cables to each other or to the vehicle body.

IMPORTANT

Please record the serial number of your unit in the space provided below and keep it as a permanent record. The serial number or the engraved serial number is located on the bottom of the unit.

SERIAL NUMBER: _____
INSTALLATION DATE: _____
INSTALLATION TECHNICIAN: _____
PLACE OF PURCHASE: _____

Installation

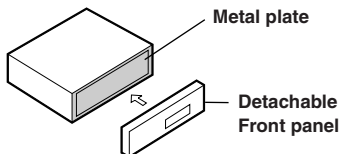

Caution

When you install this unit in your car, do not remove the detachable front panel. If the detachable front panel is removed during installation, you might press too hard and warp the metal plate that holds it in place.

Caution

Do not block the unit's fan or heat sink, thus preventing air circulation. If blocked, heat will accumulate inside the unit and may cause a fire.

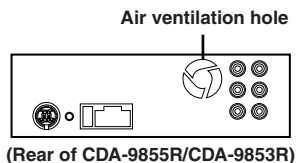

• For the screw *, provide a proper screw to the chassis installing location.

3 Slide the CDA-9855R/CDA-9853R into the dashboard. When the unit is in place, make sure the locking pins are fully seated in the down position. This can be done by pressing firmly in on the unit while pushing the locking pin down with a small screwdriver. This ensures that the unit is properly locked and will not accidentally come out from the dashboard. Install the Detachable Front Panel.

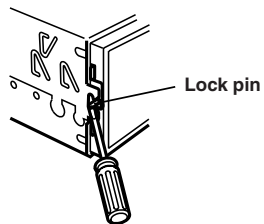

Removal

- 1 Remove the detachable front panel.
- 2 Use a small screwdriver (or similar tool) to push the locking pins to the "up" position (see above drawing). As each pin is unlocked, gently pull out on the unit to make sure it does not re-lock before unlocking the second pin.
- 3 Pull the unit out, keeping it unlocked as you do so.

1

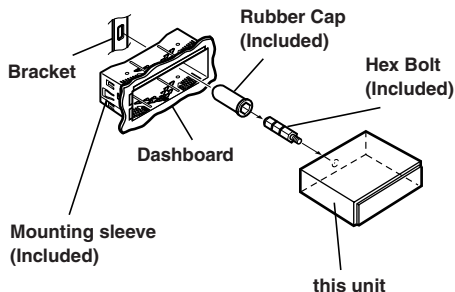

Slide mounting sleeve from main unit (see "Removal" on this page). Slide the mounting sleeve into the dashboard and fix it with the metal shackles.

<JAPANESE CAR>

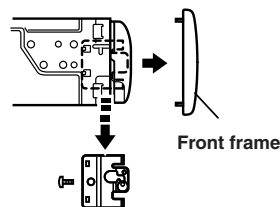

2

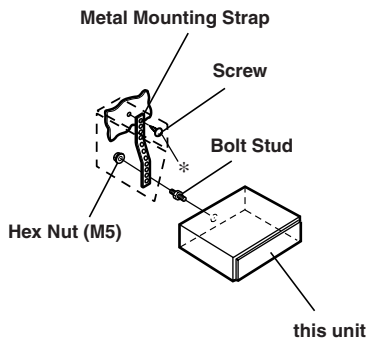

When your vehicle has the Bracket, mount the long hex bolt onto the rear panel of the CDA-9855R/CDA-9853R and put the Rubber Cap on the hex bolt. If your vehicle does not have the Mounting Support, reinforce the head unit with the metal mounting strap (not supplied). Connect all the leads of the CDA-9855R/CDA-9853R according to details described in the CONNECTION section.

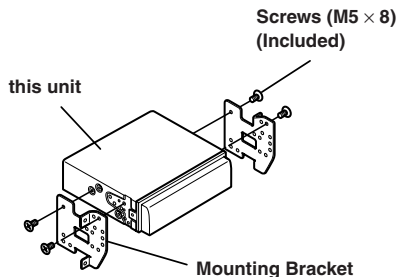

Connections

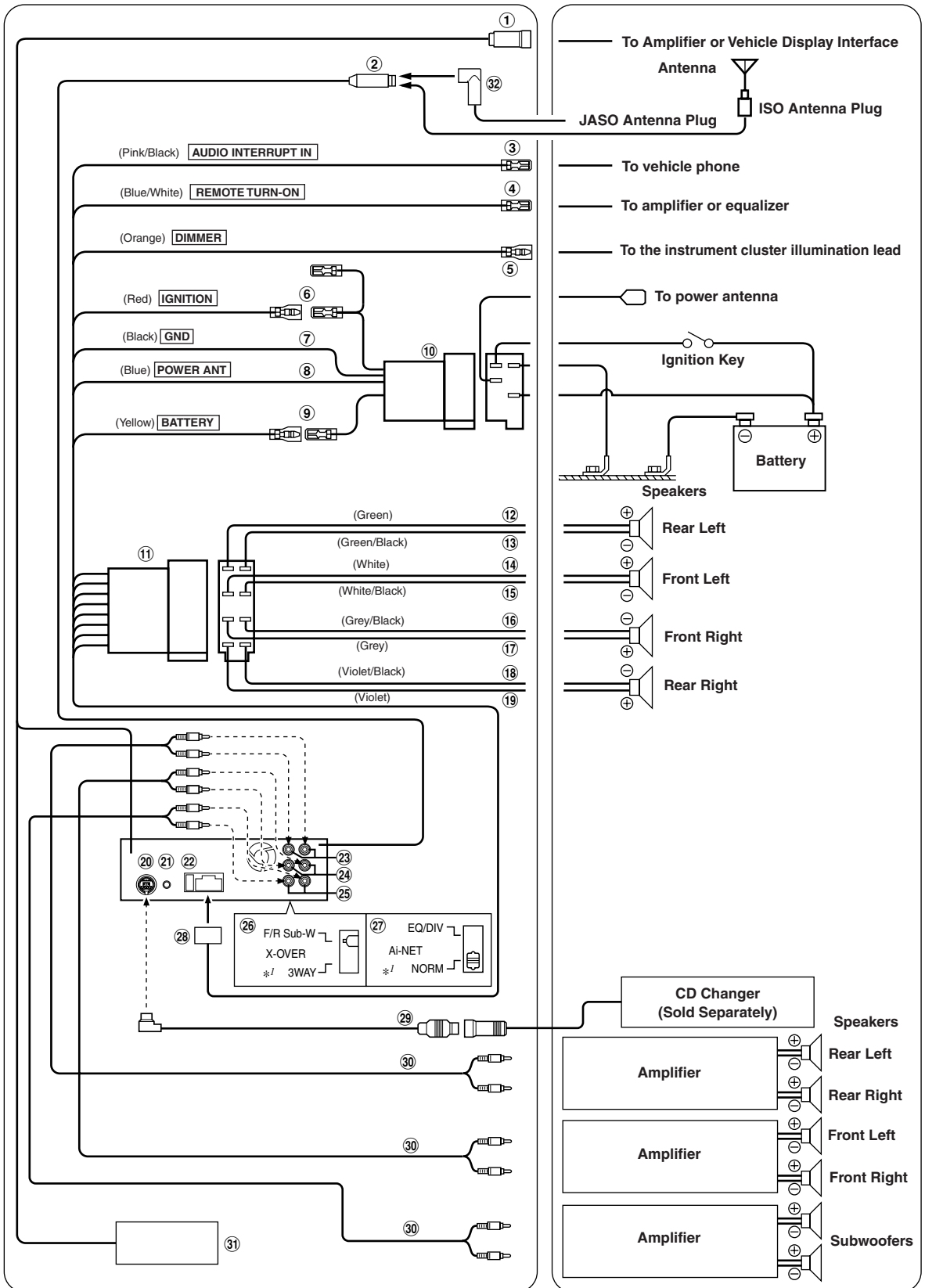

*! The label is attached on the bottom of the unit.

- ① **Amplifier Link / Vehicle Display Interface Connector**
Outputs Amplifier Link / Vehicle Display Interface control signals.
Amplifier Link: Connect this to an external Amplifier Link compatible amplifier, using the (also separately sold) Amplifier Link box KCE-511M.
Vehicle Display Interface: Connect this to the optional Vehicle Display Interface box.
 - Use the optional splitter cable to connect to both Amplifier Link box KCE-511M and Vehicle Display Interface box.
 - For details about connections, consult your nearest ALPINE dealer.
- ② **Antenna Receptacle**
- ③ **Audio Interrupt In Lead (Pink/Black)**
Connect this lead to the Audio Interface output of a cellular phone which provides ground shorting when a call is received.
- ④ **Remote Turn-On Lead (Blue/White)**
Connect this lead to the remote turn-on lead of your amplifier or signal processor.
- ⑤ **Dimmer Lead (Orange)**
This lead may be connected to the light switch of the vehicle. This will enable the switched on vehicle's light to dim the backlighting of the unit.
- ⑥ **Switched Power Lead (Ignition) (Red)**
Connect this lead to an open terminal on the vehicle's fuse box or another unused power source which provides (+) 12V only when the ignition is turned on or in the accessory position.
- ⑦ **Ground Lead (Black)**
Connect this lead to a good chassis ground on the vehicle. Make sure the connection is made to bare metal and is securely fastened using the sheet metal screw provided.
- ⑧ **Power Antenna Lead (Blue)**
Connect this lead to the +B terminal of your power antenna, if applicable.
 - This lead should be used only for controlling the vehicle's power antenna. Do not use this lead to turn on an amplifier or a signal processor, etc.
- ⑨ **Battery Lead (Yellow)**
Connect this lead to the positive (+) post of the vehicle's battery.
- ⑩ **ISO Power Supply Connector**
- ⑪ **ISO Connector (Speaker Output)**
- ⑫ **Left Rear (+) Speaker Output Lead (Green)**
- ⑬ **Left Rear (-) Speaker Output Lead (Green/Black)**
- ⑭ **Left Front (+) Speaker Output Lead (White)**
- ⑮ **Left Front (-) Speaker Output Lead (White/Black)**
- ⑯ **Right Front (-) Speaker Output Lead (Grey/Black)**
- ⑰ **Right Front (+) Speaker Output Lead (Grey)**
- ⑱ **Right Rear (-) Speaker Output Lead (Violet/Black)**
- ⑲ **Right Rear (+) Speaker Output Lead (Violet)**
- ⑳ **Ai-NET Connector**
Connect this to the output or input connector of other product (CD changer, Equalizer, iPod adapter,*² etc.) equipped with Ai-NET.
 - *² If you connect to the iPod, you need the optional adapter (KCA-420i). For details on connection, refer to the Owner's Manual of the KCA-420i.
- ㉑ **Steering Remote Control Interface Connector**
To steering remote control interface box.
- ㉒ **Fuse Holder (10A)**
- ㉓ **Rear Output RCA Connectors**
RED is right and WHITE is left.
- ㉔ **Front Output RCA Connectors**
RED is right and WHITE is left.
- ㉕ **Subwoofer Output RCA Connectors**
RED is right and WHITE is left.
- ㉖ **Setting the 3WAY/2WAY switch**
Set the 3way/2way Switch according to your audio system.
- ㉗ **System Switch**
When connecting a processor using Ai-NET, place this switch in the EQ/DIV position. When no device is connected, leave the switch in the NORM position.
 - Be sure to turn the power off to the unit before changing the switch position.
- ㉘ **Power Supply Connector**
- ㉙ **Ai-NET Cable (Included with CD Changer)**
- ㉚ **RCA Extension Cable (Sold Separately)**
- ㉛ **DC/DC Converter (CDA-9855R only).**
 - Do not install the converter at a location subjected to water such as under the floor mat or air conditioner. This may cause a malfunction.
 - Do not bundle the DC/DC converter cable with other audio cables. Doing so may induce noise into your system.
 - Keep the DC/DC converter away from the Antenna cables and the rear side of the unit, otherwise noise may be generated when receiving radio broadcast.
- ㉜ **ISO/JASO Antenna Adaptor (Sold Separately)**
An ISO/JASO antenna adapter may be required, depending on the vehicle.

Continued

The X-Over Switch position for a two-way system (frequency range is divided between highs for front/rear and lows for the Subwoofer).

The position of the X-Over switch : F/R/Sub-W

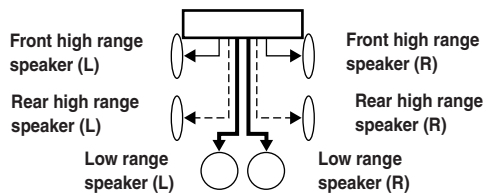

The X-Over Switch position for a three-way system whose frequency range is divided among the highs (Front), mids (Rear), and lows (Subwoofer).

The position of the X-Over switch: 3WAY

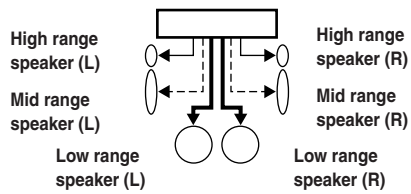

Output of this unit :

————— Front output - - - - - Rear output ——— SUB-W output

- Use the Sub-W output cord to connect the unit to the low range speaker.
- You can use the built-in amplifier to output the front output/rear output.
- You cannot adjust the fader when set to 3WAY.

To prevent noise/interference in the audio system.

- Locate the unit and route the leads at least 10 cm away from the car harness.
- Keep the battery power leads as far away from other leads as possible.
- Connect the ground lead securely to a bare metal spot (remove any paint, dirt or grease if necessary) of the car chassis.
- If you add an optional noise suppressor, connect it as far away from the unit as possible. Your Alpine dealer carries various noise suppressors, contact them for further information.
- Your Alpine dealer knows best about noise prevention measures so consult your dealer for further information.

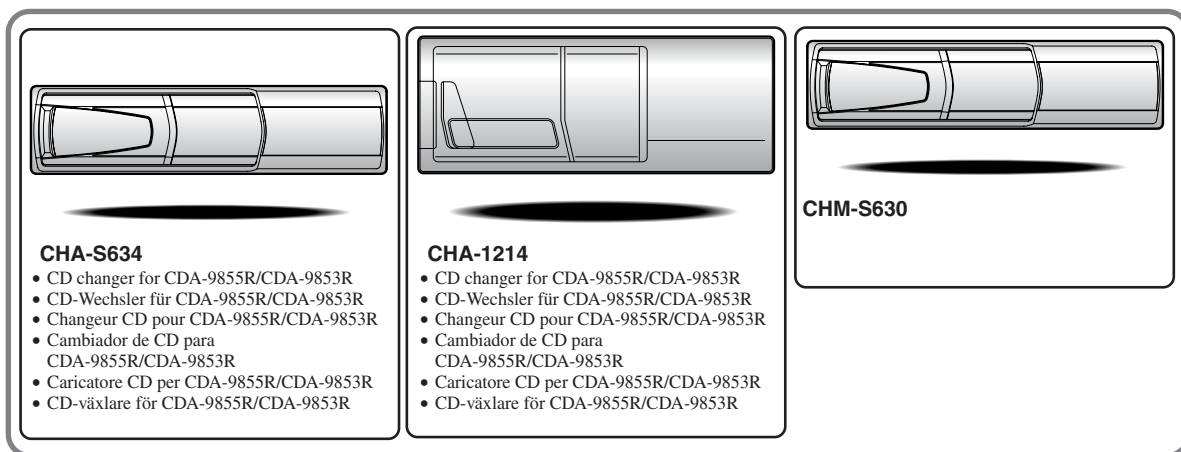

CHA-S634

- CD changer for CDA-9855R/CDA-9853R
- CD-Wechsler für CDA-9855R/CDA-9853R
- Changeur CD pour CDA-9855R/CDA-9853R
- Cambiador de CD para CDA-9855R/CDA-9853R
- Caricatore CD per CDA-9855R/CDA-9853R
- CD-växlare för CDA-9855R/CDA-9853R

CHA-1214

- CD changer for CDA-9855R/CDA-9853R
- CD-Wechsler für CDA-9855R/CDA-9853R
- Changeur CD pour CDA-9855R/CDA-9853R
- Cambiador de CD para CDA-9855R/CDA-9853R
- Caricatore CD per CDA-9855R/CDA-9853R
- CD-växlare för CDA-9855R/CDA-9853R

CHM-S630

Alpine CD Changers Give You More!

More musical selections, more versatility, more convenience.

The CHA-S634 is a high-performance 6-disc changer with a new M DAC, CD-R/RW PLAY BACK, MP3 PLAY BACK and CD TEXT. The CHA-1214 Ai-NET model holds 12 discs, and the CHM-S630 M-Bus model is a super-compact 6-disc changer with a CD-R/RW PLAY BACK.

Von Alpine CD-Wechslern haben Sie mehr!

Mehr Musikauswahl, mehr Vielseitigkeit, mehr Komfort.

Der CHA-S634 ist ein Hochleistungs-Wechsler für 6 CDs mit dem neuen M-DAC, mit CD-R/RW- und MP3-Wiedergabefunktion und mit CD-TEXT. Der CHA-1214 ist ein Ai-NET-Modell für 12 CDs. Der M-Bus-kompatible CHM-S630 ist ein superkompakter Wechsler für 6 CDs mit CD-R/RW-Wiedergabefunktion.

Changeurs de CD Alpine : vous avez le choix!

Plus de sélections musicales, plus de souplesse, plus de confort.

Le modèle CHA-S634 est un changeur 6 disques ultra performant équipé des nouvelles fonctions M DAC, CD-R/RW PLAY BACK, MP3 PLAY BACK et CD TEXT. Le modèle CHA-1214 Ai-NET contient 12 disques. Le modèle CHM-S630 M-Bus est un changeur 6 disques super compact doté de la fonction CD-R/RW PLAY BACK.

¡Los cambiadores Alpine de CD le ofrecen más!

Más selecciones musicales, más versatilidad y más ventajas.

CHA-S634 es un cambiador de seis discos de alto rendimiento con nuevo M DAC, CD-R/RW PLAY BACK, MP3 PLAY BACK y CD TEXT. El modelo CHA-1214 Ai-NET alberga 12 discos y el modelo CHM-S630 M-Bus es un cambiador de seis discos de tamaño reducido con un CD-R/RW PLAY BACK.

I caricatori CD Alpine danno di più!

Più scelta, più versatilità, più comodità.

Il modello CHA-S634 è un caricatore a 6 dischi ad elevate prestazioni dotato di un nuovo M DAC, CD-R/RW PLAY BACK, MP3 PLAY BACK e CD TEXT. Il modello CHA-1214 Ai-NET è in grado di contenere 12 dischi, il modello CHM-S630 M-Bus è un caricatore a 6 dischi ultra compatto dotato di un CD-R/RW PLAY BACK.

Alpines CD-växlare ger mer!

Fler musikval, mer variation, större bekvämlighet.

CHA-S634 är en växlare för 6 skivor med mycket höga prestanda och en ny M D/A-omvandlare samt uppspelning av CD-R/RW, MP3 och CD TEXT. CHA-1214 Ai-NET rymmer 12 skivor. CHM-S630 M-Bus är en mycket kompakt växlare med kapaciteten 6 skivor med uppspelning av CD-R/RW PLAY BACK.

Appendix

Product Information Card

Produkt-Informationskarte

Carte d'informations sur le produit

Tarjeta de información del producto

English

Filling in this Product Information Card is voluntary. If you fill in this card and send it to Alpine, your data will be tabulated into reference data for future Alpine product development. In addition, in the future you may receive information about new products or Survey Mail requesting additional opinions about Alpine products or services. If you agree to the above term, please sign your name in the indicated space and return the card. Any additional comments or inquiries may be sent to: Person in charge of Customer Service department Alpine Electronics (Europe) GmbH.
Frankfurter Ring 117, 80807 München, Germany
Phone: +49-(0)89-32 42 640

Deutsch

Das Ausfüllen dieser Produktinformations-Karte ist freiwillig. Sollten Sie diese Karte vervollständigen, so werden die Daten für zukünftige Produktentwicklungen von Alpine als Referenzdaten herangezogen. Ebenso können Sie in der Zukunft Informationen über neue Alpine Produkte erhalten oder uns auch Ihre Meinung über Alpine Produkte und Dienstleistungen im Rahmen von Kunden-Befragungen mitteilen. Stimmen Sie dem Kontakt durch Alpine zu, so würden wir Sie bitten, in dem dafür vorgesehenen Feld zu unterschreiben und die Karte kostenfrei an uns zurückzuschicken. Zusätzliche Kommentare und Meinungen können Sie gerne an den zuständigen Kontakt im Kundendienst Alpine Electronics (Europe) GmbH senden.
Frankfurter Ring 117, 80807 München, Germany
Phone: 089-32 42 640

Français

En remplissant volontairement cette fiche, et en l'envoyant à Alpine, vous acceptez que ces informations soient utilisées par Alpine, dans le cadre de développement de nouveaux produits. Par ailleurs, vous autorisez Alpine à solliciter votre opinion par mailing sur de nouveaux produits ou services. Si vous acceptez les termes ci-dessus, veuillez signer cette carte à l'endroit indiqué, et nous la retourner. Tout autre commentaire ou demande doit être adressé à l'attention de: Responsable du service consommateur Alpine Electronics (Europe) GmbH.
Frankfurter Ring 117, 80807 München, Germany
Phone: +49-(0)89-32 42 640

Español

El envío de la información solicitada es voluntario. Si Vd. nos la remite, será utilizada de modo confidencial para el desarrollo de futuros productos Alpine. Si Vd. desea recibir información sobre nuevos productos de nuestra gama, indique su nombre en el espacio designado y remitanos la tarjeta. Cualquier solicitud adicional puede ser enviada a: Persona responsable del Servicio de Atención al Cliente de Alpine Electronics (Europe) GmbH.
Frankfurter Ring 117, 80807 München, Germany
Phone: +49-(0)89-32 42 640

Q1. PRODUCT PURCHASED

1. Cassette Player
2. CD Player
3. MD Player
4. DVD Player
5. CD Changer
6. Amplifier
7. Speaker
8. Subwoofer
9. Monitor Controller
10. Video Monitor
11. Navigation
12. Processor/Equalizer
13. CD/Video CD Changer
14. Other _____

Q2. MODEL NUMBER: _____

Q3. DATE OF PURCHASE:

Month: _____ Year: _____

Q4. If navigation system, which monitor?

1. Alpine → (Model No.) _____
2. Other → (Brand Name) _____

Q5. STORE TYPE WHERE

- PURCHASED:
1. Car Audio Specialist
 2. Audio/Video Store
 3. Electronics/Appliance Store
 4. Car Accessories Shop
 5. Other _____

Q6. Type of vehicle in which this unit is installed:

Make: _____ Model: _____
Purchased Model _____
Year: _____ Year: _____

Q7. How was this vehicle purchased?

1. Purchase
2. Lease

Q8. Purpose of buying this unit?

1. Addition
 2. Replacement
- ↓
- Previous brand replaced?

1. Factory installed
2. Alpine
3. Other → (Brand Name) _____

Q9. Have you purchased Alpine products before?

1. First time
2. Two or More times

Q10. When you purchased this Alpine unit, did you compare it with other brand?

1. Yes → (Brand Name) _____
2. No

Q11. GENDER

1. Male
2. Female

Q12. AGE _____

Q13. MARITAL STATUS

1. Single
2. Married

Q14. OCCUPATION

1. Company Owner/Self-employed/
Freelance
2. Manager
3. Company Employee
4. Civil Servant
5. Educator
6. Student
7. Other _____

Q15. Comments _____

Q1. gekauftes Gerät

1. Kassetten-Spieler
2. CD-Spieler
3. MD-Spieler
4. DVD-Spieler
5. CD-Wechsler
6. Verstärker
7. Lautsprecher
8. Subwoofer
9. Monitor-Controller
10. Video-Monitor
11. Navigationssystem
12. Prozessor/Equalizer
13. CD/Video-CD-Wechsler
14. andere _____

Q2. Modellnummer: _____

Q3. Kaufdatum:

Monat: _____ Jahr: _____

Q4. Falls Navigationssystem: Welcher Monitor?

1. Alpine → (Modellnr.) _____
2. Anderer Hersteller →
(Herstellername) _____

Q5. Art des Geschäfts, in dem Sie das Gerät gekauft haben:

1. Spezialist für Auto-Audioanlagen
2. Audio/Video-Geschäft
3. Elektro-Geschäft
4. Autozubehör-Geschäft
5. Anderer Hersteller _____

Q6. Art des Fahrzeugs, in das das Gerät installiert wurde:

Marke: _____ Modell: _____
gekauft im _____
Jahr: _____ Baujahr: _____

Q7. Wie haben Sie das Fahrzeug gekauft?

1. Kauf
2. Leasing

Q8. Zweck des Kaufs dieses Geräts?

1. Zusätzlich
 2. Austausch
- ↓
- Marke des ausgetauschten Geräts?

1. Serienmäßige Ausstattung
2. Alpine
3. Anderer Hersteller →
(Herstellername) _____

Q9. War dies das erste Mal, dass Sie ein Alpine-Gerät gekauft haben?

1. Erstes Mal
2. Zweites Mal oder öfter

Q10. Haben Sie dieses Alpine-Gerät vor dem Kauf mit Geräten anderer Hersteller verglichen?

1. Ja → (Herstellername) _____
2. Nein

Q11. Geschlecht

1. Männlich
2. Weiblich

Q12. Alter _____

Q13. Familienstand

1. Ledig
2. Verheiratet

Q14. Beruf

1. Selbständige/Firmeninhaber/treiberberuflich
Tätige
2. Leitende Angestellte
3. Sonstige Angestellte
4. Beamte
5. Schulbildung
6. Studium
7. Sonstige _____

Q15. Kommentar: _____

Q1. PRODUIT ACHETE

1. Lecteur de cassette
2. Lecteur de CD
3. Lecteur MD
4. Lecteur DVD
5. Changeur de CD
6. Amplificateur
7. Haut-parleur
8. Haut-parleur de graves
9. Station Multimedia
10. Moniteur Vidéo
11. Navigation
12. Processeur/Egaliseur
13. Changeur de CD/CD Vidéo
14. Autre _____

Q2. NUMERO DU MODELE: _____

Q3. DATE D'ACHAT:

Mois: _____ Année: _____

Q4. Si c'est un système de navigation, quel moniteur?

1. Alpine → (N° du modèle) _____
2. Autre → (Marque) _____

Q5. TYPE DE MAGASIN OU VOUS

- AVEZ ACHETE LE PRODUIT:
1. Spécialiste autoradio
 2. Magasin audio/vidéo
 3. Magasin d'électronique/appareils
 4. Magasin d'accessoires automobiles
 5. Autre _____

Q6. Type de véhicule dans lequel cet appareil est installé:

Marque: _____ Modèle: _____
Année _____ Année du
d'achat: _____ modèle: _____

Q7. Comment avez-vous acheté ce véhicule?

1. Achat
2. Location-bail

Q8. Pourquoi avez-vous acheté cet appareil?

1. Addition
 2. Remplacement
- ↓
- Marque précédente remplacée?

1. Installée en usine
2. Alpine
3. Autre → (Marque) _____

Q9. Aviez-vous déjà acheté des produits Alpine?

1. Première fois
2. Deux fois ou plus

Q10. Lorsque vous avez acheté ce produit Alpine, l'avez-vous comparé à une autre marque?

1. Oui → (Marque) _____
2. Non

Q11. SEXE

1. Masculin
2. Féminin

Q12. AGE _____

Q13. SITUATION DE FAMILLE

1. Célibataire
2. Marié

Q14. PROFESSION

1. Entrepreneur/Travailleur indépendant/
Free-lance
2. Directeur
3. Employé de bureau
4. Fonctionnaire
5. Educateur
6. Etudiant
7. Autre _____

Q15. Commentaires _____

Q1. Producto Comprado

1. Radio/Cassette
2. Radio/CD
3. Reproductor de MD
4. Reproductor de DVD
5. Cambiador de CD
6. Amplificador
7. Altavoz
8. Subwoofer
9. Monitor de control
10. Monitor de video
11. Sistema de navegación
12. Procesador/Equalizador
13. Cambiador de CD/Video CD
14. Otros _____

Q2. Número de modelo: _____

Q3. Fecha de compra:

Mes: _____ Año: _____

Q4. En caso de sistema de navegación, ¿qué monitor?

1. Alpine → (N° de modelo) _____
2. Otro → (Nombre de marca) _____

Q5. TIPO DE TIENDA DONDE

- COMPRÓ:
1. Especialista en audio de automóviles
 2. Tienda de audio/video
 3. Tienda de electrónica/electrodomésticos
 4. Tienda de accesorios automovilísticos
 5. Otros _____

Q6. Tipo de vehículo en que la unidad está instalada:

Marca: _____ Modelo: _____
Año de _____ Año del
compra: _____ modelo: _____

Q7. ¿Cómo fue comprado este vehículo?

1. compra
2. Leasing

Q8. ¿Propósito de comprar esta unidad?

1. Mejora del sistema
 2. Sustitución
- ↓
- ¿Sustitución de marca anterior?

1. Instalée en fábrica
2. Alpine
3. Otros → (Nombre de marca) _____

Q9. ¿Ha comprado Vd. productos Alpine anteriormente?

1. Primera vez
2. Dos o más veces

Q10. Cuando usted compró esta unidad Alpine, ¿la comparó con otros fabricantes?

1. Si → (Nombre de marca) _____
2. No

Q11. SEXO

1. Masculino
2. Femenino

Q12. Edad _____

Q13. Estado civil

1. Soltero
2. Casado

Q14. Ocupación

1. Propietario de empresa/Autónomo/
Profesional independiente
2. Gerente
3. Empleado de compañía
4. Empleado público
5. Profesor
6. Estudiante
7. Otros _____

Q15. Comentarios _____

Scheda informazioni prodotto

Italiano

La compilazione di questa formulario è volontaria. Se compilate questo formulario, ritornandolo ad Alpine, i Vostri dati saranno raccolti in un file di riferimento per lo sviluppo dei nuovi prodotti Alpine. In aggiunta Voi potrete ricevere in futuro informazioni riguardanti i nuovi prodotti o la richiesta di una Vostra opinione circa i prodotti o i servizi forniti da Alpine. Se siete d'accordo, Vi preghiamo di ritornarci il formulario compilato negli appositi spazi con i Vostri dati. In caso desideriate fornire altri commenti o richiedere informazioni aggiuntive, potete indirizzare il tutto a : Responsabile dipartimento Servizio Clienti Alpine Electronics (Europe) GmbH.
Frankfurter Ring 117, 80807 München, Germany
Phone: +49-(0)89-32 42 640

Q1. PRODOTTO ACQUISTATO

1. Lettore di cassette
2. Lettore CD
3. Lettore MD
4. Lettore DVD
5. CD Changer
6. Amplificatore
7. Altoparlante
8. Subwoofer
9. Radio Monitor
10. Monitor video
11. Sistema di navigazione
12. Processore/equalizzatore
13. Cambia CD/Video CD
14. Altro _____

Q2. NUMERO MODELLO: _____

Q3. DATA DI ACQUISTO:

Mese: _____ Anno: _____

Q4. In caso di acquisto di un sistema di navigazione, quale monitor possiede?

1. Alpine → (No. Modello) _____
2. Altro → Nome marca _____

Q5. NEGOZIO DI ACQUISTO:

1. Specialista Car Stereo
2. Negozio di audio/video
3. Negozio di elettronica/elettrodomestici
4. Negozio accessori automobile
5. Altro _____

Q6. Tipo di veicolo posseduto:

Marca: _____ Modello: _____
Anno _____ Anno _____
acquisto: _____ modello: _____

Q7. Modalità acquisto

1. Acquisto
2. Leasing

Q8. Scopo acquisto

1. Aggiunta
 2. Sostituzione
- ↓
- Marca sostituita
 - 1. Installato di fabbrica
 - 2. Alpine
 - 3. Altro → (Nome marca) _____

Q9. Avevate già acquistato prodotti Alpine?

1. No
2. Due o tre volte

Q10. Nell'acquistarlo, avete paragonato questo prodotto ad un'altra marca?

1. Sì → (Nome marca) _____
2. No

Q11. SESSO

1. Maschile
2. Femminile

Q12. ETÀ _____

Q13. STATO CIVILE

1. Celibe/nubile
2. Coniugato/coniugata

Q14. LAVORO

1. Proprietario di azienda/artigiano/libero professionista
2. Manager
3. Impiegato
4. Impiegato statale
5. Insegnante
6. Studente
7. Altro _____

Q15. Commenti _____

- ◆ I agree to the above stated terms of the Alpine Product Information Card.
- ◆ Ich stimme dem Kontakt durch Alpine für Informations- und Befragungszwecke zu.
- ◆ J'accepte les termes de cette carte d'information produit Alpine.
- ◆ Estoy conforme con los términos de la tarjeta de información sobre producto de Alpine.
- ◆ Accetto i termini della scheda informazioni prodotti Alpine.

_____ (Date/Datum/Date/Fecha/Data)

_____ (Signature/Unterschrift/Signature/Firma)

Name/Nom/Nombre/Nome

(First Name/Vorname/Prénom/Primer nombre/Nome)

(Surname/Familiennome/Nom de famille/Apellido/Cognome)

Home Address/Privatanschrift/Adresse/Dirección/Indirizzo

(Street/Straße/Rue/Calle/Via) (Post Code/Postleitzahl/Code postal/Código postal/Codice postale)

(Town/City/Stadt/Ville/Ciudad/Città) (Country/Land/Pays/Pais/Paese)

Telephone Number: _____

E-Mail/Correo electrónico: _____

Q1 NO. Other	Q2
-----------------	----

Q3 Month	Year	Q4 NO.1. Model No.
NO.2. Brand Name		

Q5 NO. Other	Q6 Make:	Model:
	Purchased Year:	Model Year:

Q7 NO.	Q8 NO. 1	Previous brand replaced.	Brand Name
	2	1. 2. 3.	

Q9 NO.	Q10 1 → Brand Name	Q11 NO.
	NO. 2	

Q12 years old	Q13 NO.	Q14 NO. Other
---------------------	---------	------------------

Q15 Comments _____

LUFTPORT
PAR AVION
PRIORITAIRE

NE PAS AFFRANCHIR

NICHT FREIMACHEN
NO STAMP REQUIRED

REPOSE PAYEE/ WERBEANTWORT
ALLEMAGNE

ALPINE ELECTRONICS (EUROPE) GmbH
Frankfurter Ring 117, 80807 München,
Germany