

SERIAL NUMBER: \_\_\_\_\_  
 INSTALLATION DATE: \_\_\_\_\_  
 INSTALLATION TECHNICIAN: \_\_\_\_\_  
 WHERE PURCHASED: \_\_\_\_\_

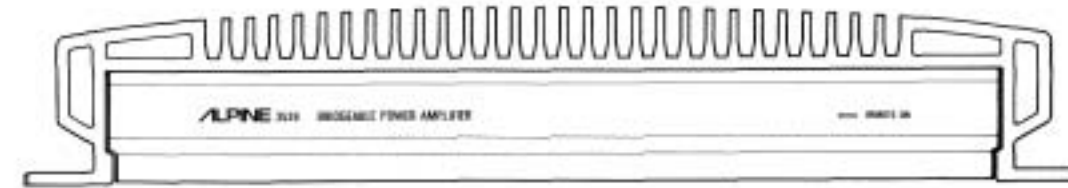

**BRIDGEABLE  
POWER  
AMPLIFIER**

**ALPINE ELECTRONICS INC.**  
 Tokyo Office: 1-1-8 Nishi Gotanda,  
 Shinagawa-ku, Tokyo, Japan 141  
 Phone 03-494-1101

**ALPINE ELECTRONICS OF CANADA, INC.**  
 605 Alden RD. Markham,  
 Ontario L3R 3L5 Canada  
 Phone 416-475-7280 Telex 06-986789

**ALPINE ELECTRONICS OF AMERICA, INC.**  
 19145 Gramercy Place  
 Torrance, California 90501  
 Phone 213-326-8000

**ALPINE ELECTRONICS GmbH**  
 Münsterstr. 330 D-4000 Düsseldorf  
 F.R. Germany  
 Tel. 0211-626806 Telex 8588 296 ALPI D

88P93881F13-A  
 Printed in Japan

# 3539

## INSTALLATION

Due to the high power output of the 3539, considerable heat is produced when the unit is in operation. For this reason, the unit should be mounted in a location which will allow for free circulation of air. Inside the trunk may be optimum for installation of the 3539.

1. Using the unit as template, mark the four screw locations.
2. Drill the screw holes.
3. Position the 3539 over the screw holes, and secure with four self-tapping screws.

**NOTE:**  
 Use an already installed screw on the metal part of the car (marked "\*" in the drawing to the right) to secure the ground lead.

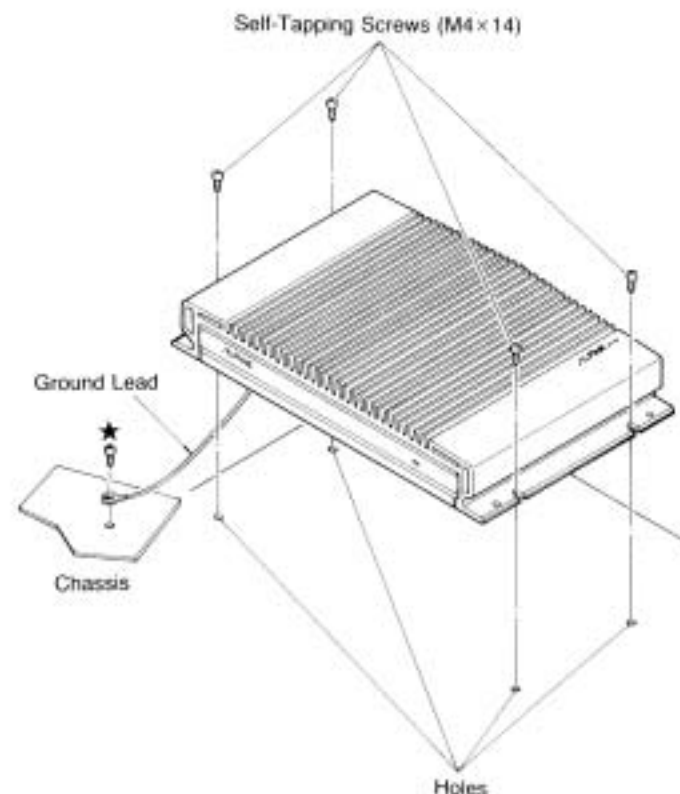

**IMPORTANT**

Please record the serial number of your unit in the space provided on the back cover and keep as a permanent record. The serial number plate is located on the bottom of the unit.

## SWITCHES AND TERMINALS

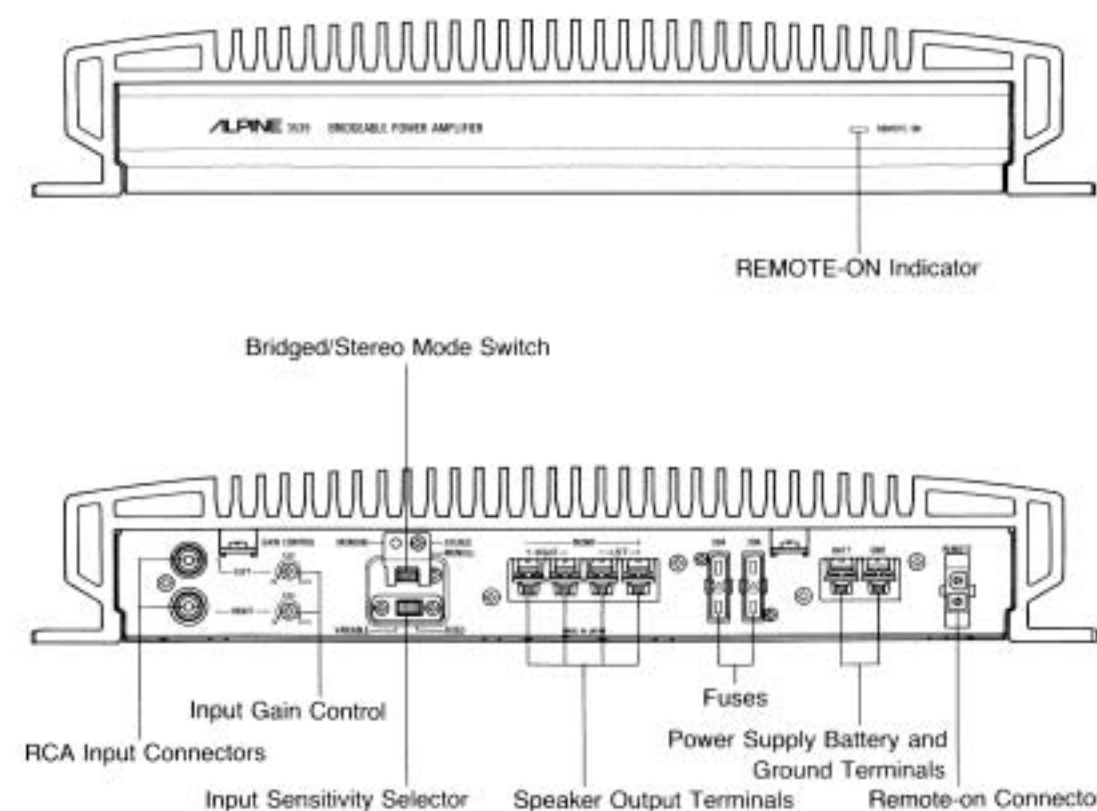

# FEATURES

Your Alpine Model 3539 Power Amplifier was designed to provide home hi-fi sound quality in the car environment. And, as with all Alpine products, excellent product reliability and ease of operation are provided as well.

The 3539 Power Amplifier delivers 150 watts per channel into 4 ohms, 200 watts per channel into 20 ohms or 400 watts bridged mono into 4 ohms throughout the audio frequency bandwidth with extremely low distortion. With advanced electronic devices and circuitries, the 3539 is fully protected from over heating and short-circuiting.

Please read this manual thoroughly to familiarize yourself with all the features and controls. Should you have any questions, please contact the Alpine Technical Services Department as 213-326-8000.

• **PWM DC-to-DC SWITCHING MODE POWER SUPPLY:**

The high power output of the 3539 is achieved through the use of a Pulse Width Modulation DC-to-DC switching mode power supply. It provides excellent frequency and power response characteristics and performance that rivals that of home audio equipment. This power supply allows the 3539 to exceed its power output specs down to 12.5 battery voltage as opposed to the customary 14.4 V.

• **BRIDGED/STEREO MODE SWITCH:**

In the bridged mode, the left and right channels become one mono amplifier. The output power in this mode is multiplied and will drive large subwoofers easily.

• **Remote Power On/Off:**

When you turn the power of your head unit on or off, the 3539 turns on and off automatically.

• **Power On Indicator**

• **Gold-Plated RCA Inputs:**

For excellent sonic quality and compatibility with most audio components.

• **Input Sensitivity Selector:**

Fixed: 500 mV  
Variable: 100 mV — 2V

• **Speaker Impedance: 4 or 2 ohms (Stereo), 4 ohms (Bridged Mono)**

• **Gold-Plated Power & Speaker Connectors:**

For optimum power transfer and immunity to corrosion.

# PRECAUTIONS

1. Improper wiring connections could cause damage to your unit. Carefully follow the wiring instructions in this manual.
2. The battery lead to the (+) terminal of the battery should be the last connection after all other connections are made.
3. Due to the high power output of the 3539, it is important that all connections are clean and well secured, or damage could result.
4. Be sure that the 3539 is mounted in a way that will allow for free air circulation and heat dissipation.
5. When changing fuses, be sure to replace the old fuse with one of the same amperage. Use of improper fuses can lead to serious damage to components.

# SPECIFICATIONS (EIA-517)

Power Output (W) STEREO MODE (at 12.5 V battery voltage)

A. Min. RMS. 4 Ohms, 20 Hz to 20 kHz  
at 0.08% THD ..... 150x2

B. Min. RMS. 2 Ohms, 20 Hz to 20 kHz  
at 0.8% THD ..... 200x2

Power output (W) Bridged Mono Mode (at 12.5 V battery voltage)

Dynamic Power  
Stereo: 200 Watts into 4 ohms/300 Watts into 2 ohms  
Bridged: 600 Watts into 4 ohms

Min. RMS. 4 ohms, 20 Hz to 20 kHz at 0.8% THD ..... 400Wx1

Frequency Response (Hz) +0, -1 dB ..... 10—50k

Signal To Noise Ratio (dBA)  
(referenced to rated Power Output) ..... 110

Input Sensitivity/Impedance (mV/Ohms)  
(for rated Power Output)  
Fixed ..... 500/10k  
Variable ..... 100—2,000/10k

Speaker Impedance (Ohms) ..... 4 or 2 (Stereo)  
4 (Bridged Mono)

Power Requirement ..... DC 14.4V  
(11 to 16V allowable)

Dimensions (WxHxD) ..... 300x53x200 mm  
(11-13/16"x2-1/16"x7-7/8")

Weight ..... 3.5 kg (7 lb, 10 ozs)

**NOTE:**

For product improvement, specifications and design are subject to change without notice.

# SYSTEM CHART

SYSTEM A

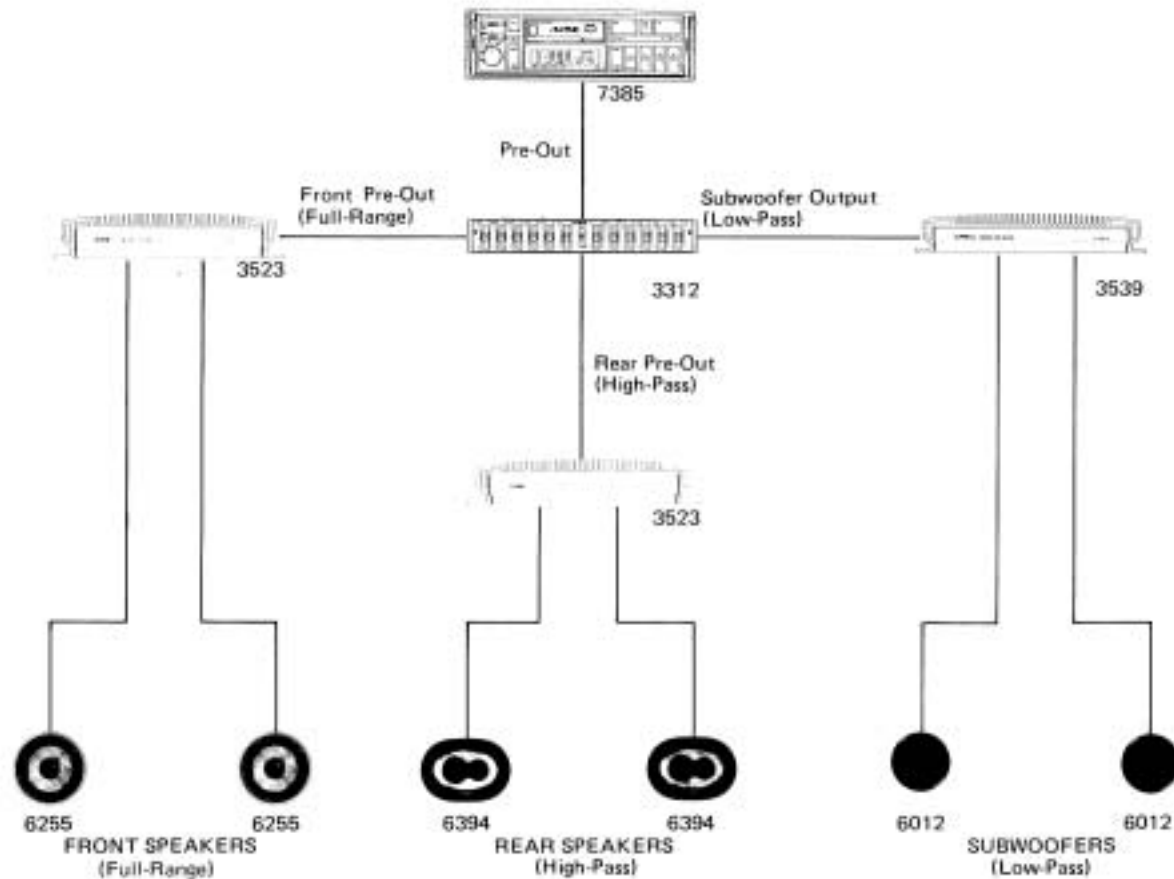

SYSTEM B

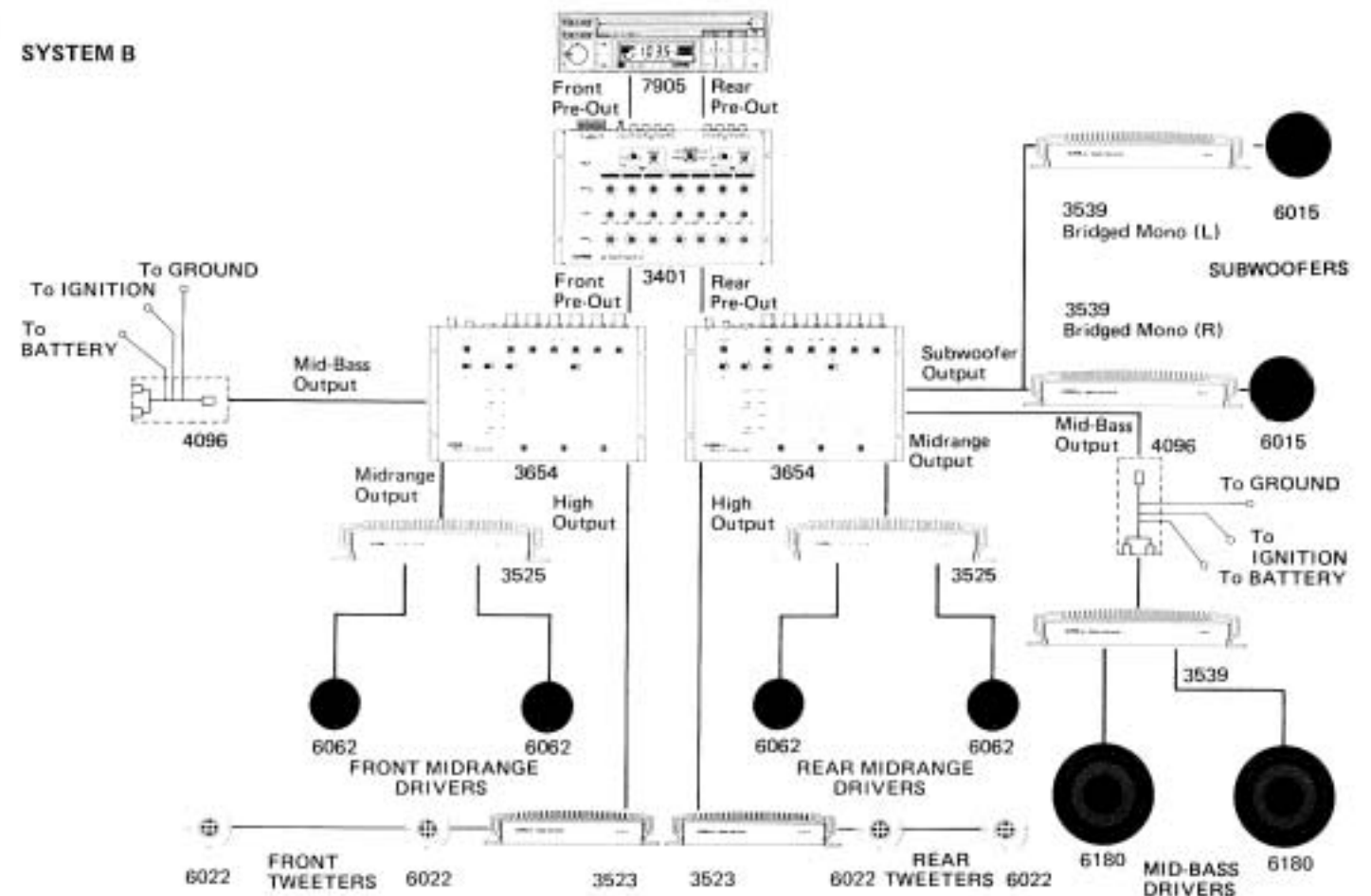

# CONNECTIONS AND OPERATION

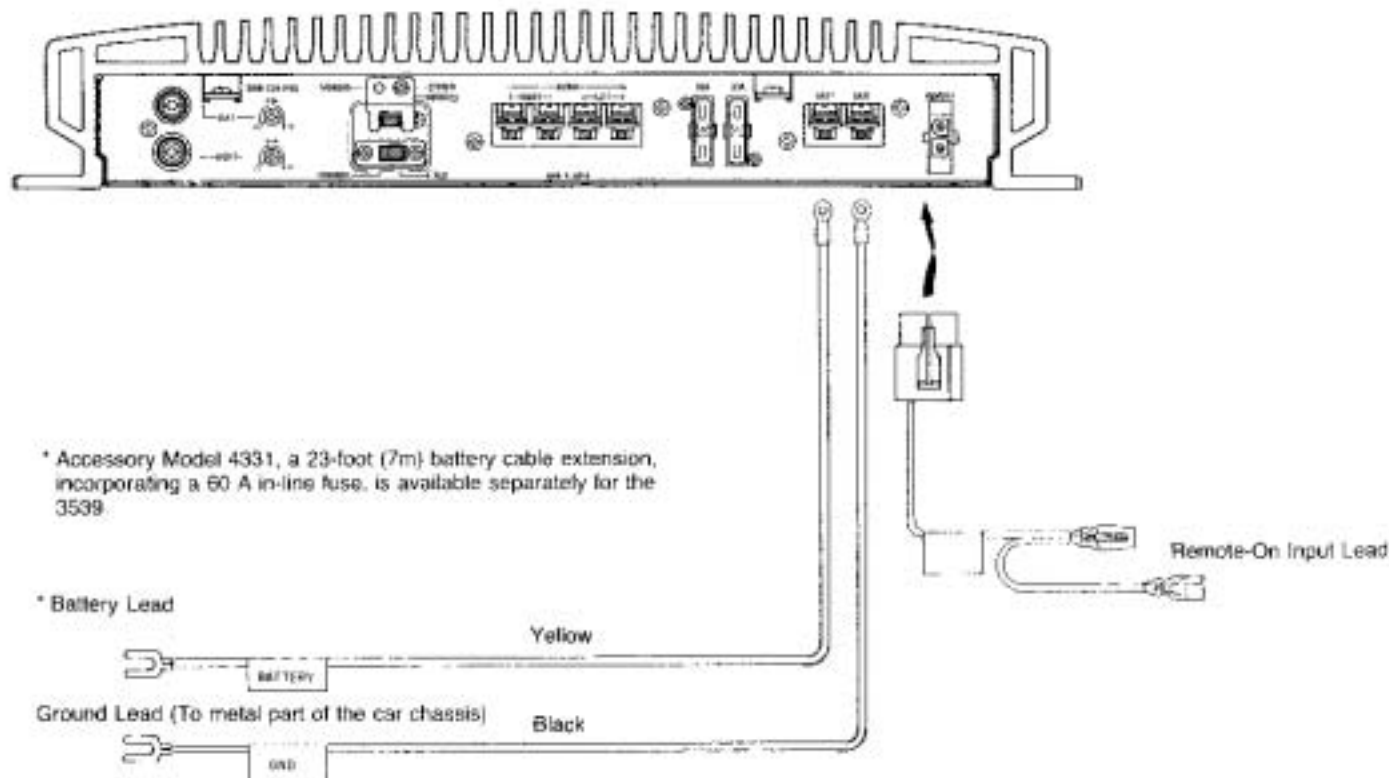

\* Accessory Model 4331, a 23-foot (7m) battery cable extension, incorporating a 60 A in-line fuse, is available separately for the 3539.

\* Battery Lead

Ground Lead (To metal part of the car chassis)

## Remote-On Input Lead

Connect the remote-on lead or the power antenna output of the head unit (which provides a +12V remote-on signal when the head unit is on) to the 3539's remote-on lead's Male connector. Connect the Female end of the amplifier's remote-on lead to other alpine amplifiers used in the system that need a remote-on wire connection.

## NOTE:

Rubber sleeves are provided with the 3539 to shield and protect wiring connections. The round sleeves are for battery and ground leads, and the oblong ones are for speaker leads. Slip each lead through the appropriate sleeve. After the lead is connected to the appropriate terminal, slide the sleeve and cover the lead and terminal.

## OPERATION

The Alpine 3539 is a high-power, high-efficiency power amplifier designed especially for use with Alpine pre-amp only head units and Bi-Level series, all of which have a pre-out for one-snap connection. The 3539 works with other components such as Alpine Equalizers (3312, 3321 etc.) or Alpine Electronic Active Dividing Networks (3652, 3654), none of which has an amplifier of their own. Input gain controls are also provided. For connections, please refer to the illustration above.

## NOTE:

The 3539 has RCA inputs only. A DIN-to-RCA adapter is supplied with the unit to facilitate connection with older Alpine head unit using DIN pre-amp outputs. However, the 3539 can not supply power to Alpine head unit & accessories through the DIN cable. If it is desired to use the 3539(s) in a system using other Alpine components which receive their power through the DIN cable, use the Alpine Accessory Model 4096 and connect its RCA output to the 3539's RCA input. One 4096 is sufficient regardless of the number of 3539's in a system.

## CONNECTIONS

1. After the 3539 is securely mounted, following the installation steps above, connect the output plugs of the head unit to the input jacks of the 3539.
2. Connect the speakers to the output terminals of the 3539.
3. Connect the Remote-On Lead or the Power Antenna Lead (this provides a remote-on signal when the power is turned on) from the head unit to the Remote On lead of the 3539.

## NOTE:

If these leads are not connected together, the 3539 will not turn on when the head unit is turned on. If your head unit does not have a power antenna output, a toggle switch (SPST) must be connected between an ignition source (+12V) and the remote-on input lead of the amplifier to provide the turn on signal for the 3539.

4. Secure the ground lead to a clean and bare metal spot.
5. Connect the battery lead directly to the battery terminal.
6. Set the Input Selector Switch to the "VARIABLE" position and adjust the Input Gain Control (0.1V - 2V) for the maximum sound volume with no clipping distortion.



## GAIN CONTROL



# BRIDGING YOUR POWER AMPLIFIER

The 3539 can be used as a bridged single channel amplifier if higher output levels are desired.

By switching the Bridged/Stereo Mode switch on the 3539 and changing speaker lead and terminal connections, you can set the 3539 for bridged mode operation. To switch to the "Bridged mode" operation, follow the steps below:

## 1. Speaker Output Connections

Connect speaker leads (+) and (-) with terminal L (+) and R (+) [see the markings at the top of the drawing]. Do not use terminals marked L (-) and R (-).

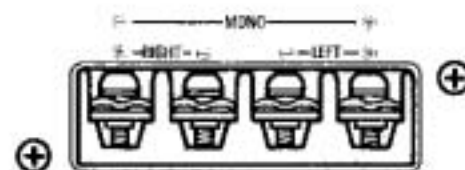

Speaker output connections should have the same polarity for both amplifiers.

## 1. 3539 Left Channel Amplifier Speaker Out



## 2. 3539 Right Channel Amplifier Speaker Out

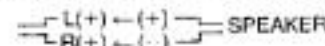

## 2. Bridged/Stereo Mode Switch

When the switch is set to Mono (L), the amplifier accepts the left channel input only. When the switch is set to Mono (R), the amplifier accepts the right channel input only.

If you wish to drive two bridged amplifiers to produce a stereo image, set the Mode switch of the left channel amplifier to MONO (L) and the Mode switch of the right channel amplifier to MONO (R). See below.

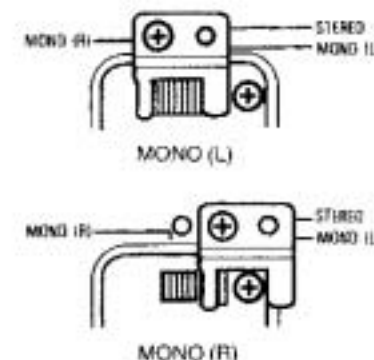

## NOTE:

To adjust the variable input sensitivity in the bridged mode, use the right channel gain control when the right channel is bridged; likewise, use the left channel gain control when the left channel is bridged.

# CHARACTERISTIC CURVES

POWER VS. DISTORTION CURVE

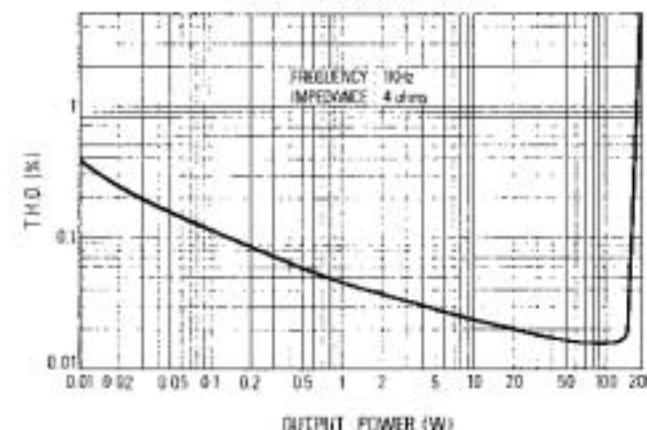

FREQUENCY RESPONSE CURVE

