



TYPE-R SUBWOOFER
HAUT-PARLEUR D'EXTRÊMES GRAVES TYPE-R
APPLICATION GUIDE
GUIDE D' APPLICATION

SWR-1243D

12 Inch Dual Voice Coil Subwoofer (4Ω)+(4Ω)
Haut-parleur d'extrêmes graves à double bobine 12 po (4Ω)+(4Ω)

SWR-1223D

12 Inch Dual Voice Coil Subwoofer (2Ω)+(2Ω)
Haut-parleur d'extrêmes graves à double bobine 12 po (2Ω)+(2Ω)

SWR-1043D

10 Inch Dual Voice Coil Subwoofer (4Ω)+(4Ω)
Haut-parleur d'extrêmes graves à double bobine 10 po (4Ω)+(4Ω)

SWR-1023D

10 Inch Dual Voice Coil Subwoofer (2Ω)+(2Ω)
Haut-parleur d'extrêmes graves à double bobine 10 po (2Ω)+(2Ω)

Example 1 One Amplifier and One Subwoofer

Exemple 1 1 amplificateur et 1 h.-p. d'extrêmes graves

JUMPER / CAVALIER

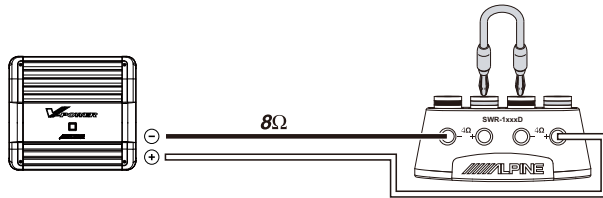

Example 2 One Amplifier and One Subwoofer

Exemple 2 1 amplificateur et 1 h.-p. d'extrêmes graves

JUMPER / CAVALIER

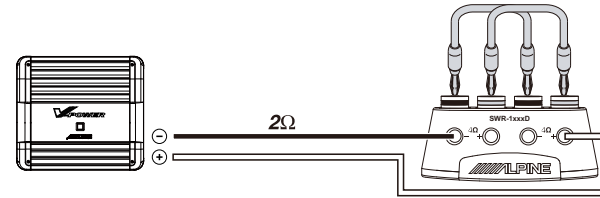

Example 3 Two Amplifiers and One Subwoofer

Exemple 3 2 amplificateurs et 1 h.-p. d'extrêmes graves

Example 4 One Amplifier and Two Subwoofers

Exemple 4 1 amplificateur et 2 h.-p. d'extrêmes graves

JUMPER / CAVALIER

JUMPER / CAVALIER

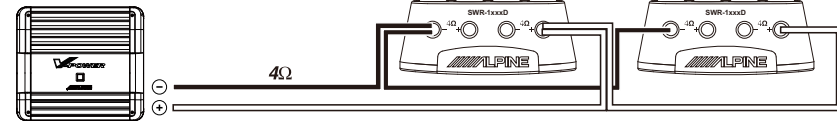
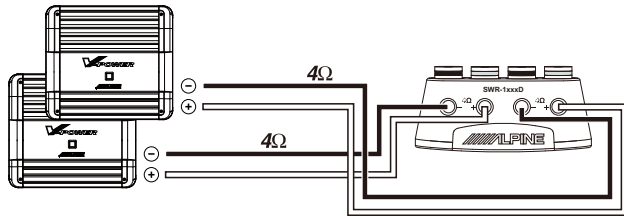

Example 5 One Amplifier and Three Subwoofers

Exemple 5 1 amplificateur et 3 h.-p. d'extrêmes graves

JUMPER / CAVALIER

JUMPER / CAVALIER

JUMPER / CAVALIER

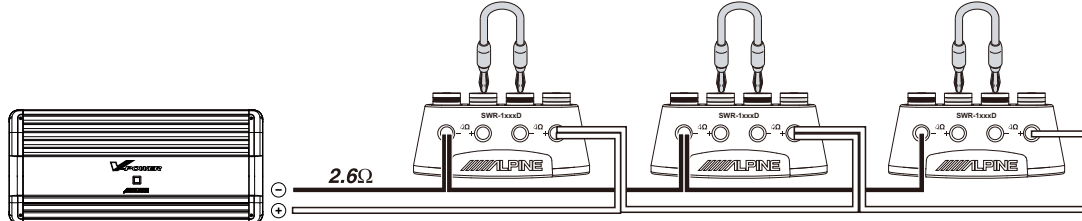

Example 6 One Amplifier and Four Subwoofers

Exemple 6 amplificateur et 4 h.-p. d'extrêmes graves

JUMPER / CAVALIER

JUMPER / CAVALIER

JUMPER / CAVALIER

JUMPER / CAVALIER

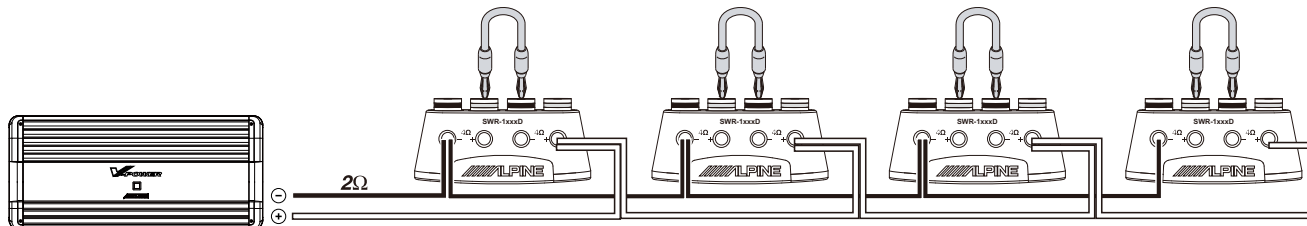

Example 1 One Amplifier and One Subwoofer

Exemple 1 1 amplificateur et 1 h.-p. d'extrêmes graves

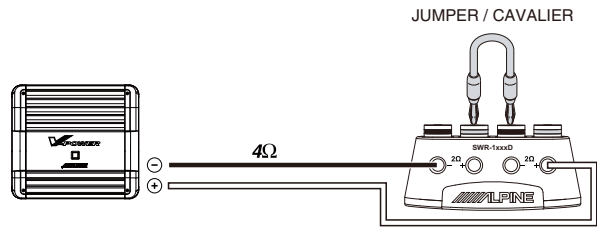

Example 2 One Amplifier and One Subwoofer

Exemple 2 1 amplificateur et 1 h.-p. d'extrêmes graves

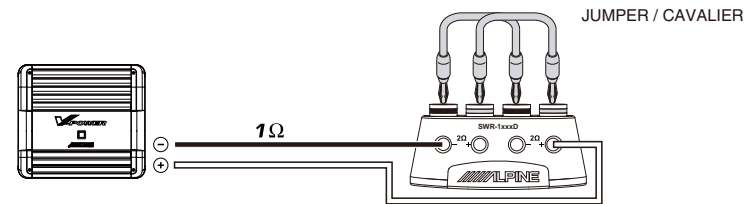

Caution ! Consult amplifier owner's manual for 1Ω connection.
Attention : lire le manuel de l'amplificateur pour la connexion à 1Ω .

Example 3 Two Amplifiers and Two Subwoofers

Exemple 3 2 amplificateurs et 2 h.-p. d'extrêmes graves

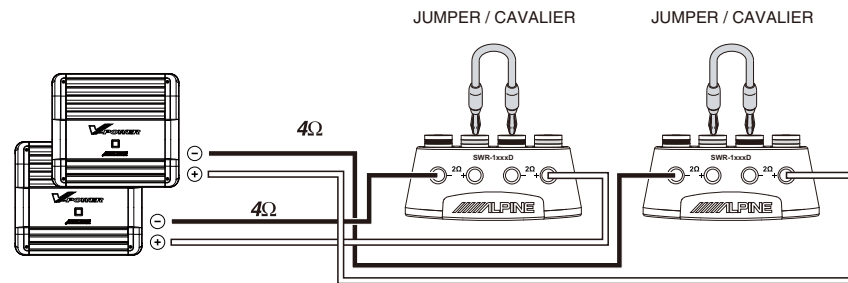

Example 4 One Amplifier and Two Subwoofers

Exemple 4 1 amplificateur et 2 h.-p. d'extrêmes graves

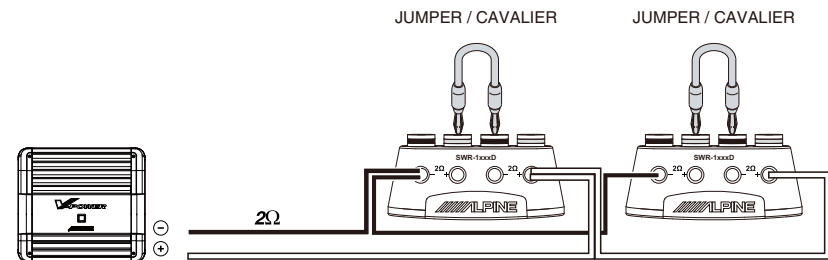

Example 5 Eight Amplifiers and Four Subwoofers-Competition Diagram

Exemple 5 8 amplificateurs et 4 h.-p. d'extrêmes graves - schéma de compétition

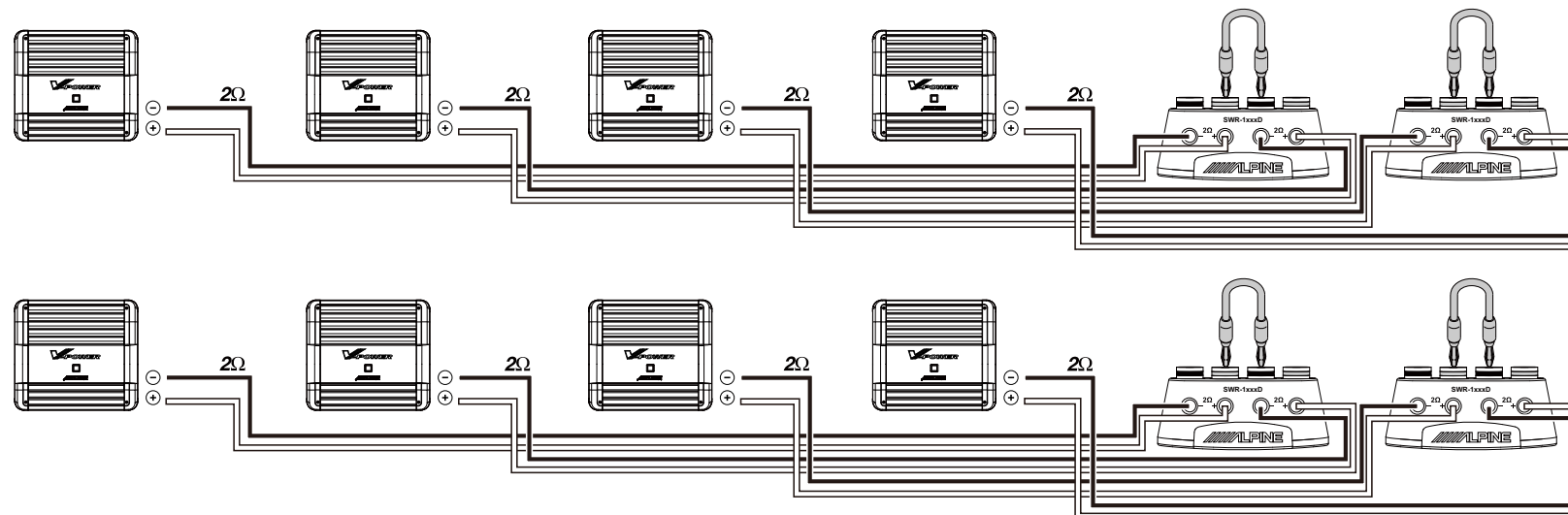

Subwoofer Features and Specifications		Type-R			
		SWR-1023D	SWR-1043D	SWR-1223D	SWR-1243D
Features					
Size		10"	10"	12"	12"
Power Handling (RMS/peak)		600W/1800W	600W/1800W	600W/1800W	600W/1800W
Power Range (RMS)		300W-600W	300W-600W	300W-600W	300W-600W
Frequency Response (Hz)		26Hz-200Hz	26Hz-200Hz	24Hz-200Hz	24Hz-200Hz
Diaphragm	Material	Kevlar-Reinforced Pulp Fiber			
	Design	2-Piece Structural Parabolic			
Surround	Material	Injection Molded Santoprene®			
	Design	High Amplitude Multi-Roll (Patent Pending)			
Spider	Material	Nomex®			
	Design	Progressive			
Voice Coil	Material	180°C High Temp Wire on Spiral Cut Aluminum Former			
	Design	4-Layer Dual Voice Coil			
Motor Structure	Pole Geometry	Compound Radius Curve (US Patent #6,639,993)			
	Configuration	Integrated Shorting Sleeve with Radial Vented VC Heat Transfer (US Patent # 7,634,101)			
Magnet	Material	High-Power Strontium Ferrite			
	Configuration	10-Piece Radially Segmented, Double Stacked			
Frame	Material	Cast Aluminum			
	Design	Single-Piece Casting with Airflow Management System (Patent Pending)			
Terminals	Layout	One Sided			
	Design	Heavy Duty 8ga. Push with Housing, Banana Plug Jumper			
Tinsel Leads	Design	Reinforced Layer Spider Integration (US Patent #6,810,988)			
Gasket	Design	Concealed Mount Gasket System and Integrated Grill Ready (Patent Pending)			
Enclosure Information					
Mounting Depth		149 mm (5.875")	149 mm (5.875")	162 mm (6.375")	162 mm (6.375")
Mounting Diameter - Front Mount		231 mm (9.1")	231 mm (9.1")	275 mm (10.9")	275 mm (10.9")
Displacement - Front Mount**		0.080 ft ³	0.080 ft ³	0.100 ft ³	0.100 ft ³
Added Volume - Reverse Mount (magnet out)**		0.055 ft ³	0.055 ft ³	0.090 ft ³	0.090 ft ³
Recommended Enclosure Alignments		Sealed, Vented, Bandpass			
Sealed Box Volume Range (Gross)		0.5-1.0 ft ³	0.5-1.0 ft ³	0.65-1.25 ft ³	0.65-1.25 ft ³
Optimum Sealed Box	External Box Dimensions	12.5" x 12.5" x 10"	12.5" x 12.5" x 10"	14.5" x 14.5" x 10.5"	14.5" x 14.5" x 10.5"
	Gross Internal Volume	0.60 ft ³	0.60 ft ³	0.90 ft ³	0.90 ft ³
	Net Internal Volume**	0.50 ft ³	0.50 ft ³	0.75 ft ³	0.75 ft ³
	F ₃ , Q _{tc}	43 Hz, 0.90	46 Hz, 0.90	44 Hz, 0.90	43 Hz, 0.90
Vented Box Volume Range (Gross)		0.8-1.5 ft ³	0.8-1.5 ft ³	1.0-2.0 ft ³	1.0-2.0 ft ³
Optimum Vented Box	External Box Dimensions	12.5" x 12.5" x 20.5"	12.5" x 12.5" x 20.5"	13.5" x 13.5" x 24"	13.5" x 13.5" x 24"
	Gross Internal Volume	1.4 ft ³	1.4 ft ³	1.9 ft ³	1.9 ft ³
	Vent Area (dimensions)	11 in ² (11" x 1")	11 in ² (11" x 1")	15 in ² (12" x 1.25")	15 in ² (12" x 1.25")
	Vent Length	18.5"	18.5"	22"	22"
	Vent Displacement	0.24 ft ³	0.24 ft ³	0.29 ft ³	0.29 ft ³
	Net Internal Volume (V _b)***	1.1 ft ³	1.1 ft ³	1.5 ft ³	1.5 ft ³
F ₃ , ripple, F _b		26Hz, 4.2dB, 35Hz	28Hz, 4.5dB, 35Hz	27Hz, 4.2dB, 33Hz	27Hz, 3.9dB, 33Hz
Electro-Mechanical Parameters [#]					
Nominal Impedance		2Ω+2Ω	4Ω+4Ω	2Ω+2Ω	4Ω+4Ω
Frequency Response		26 - 200Hz	26 - 200Hz	24 - 200Hz	24 - 200Hz
Sensitivity (SPL@1W/1m)*		83dB	83dB	85dB	85dB
D.C Coil Resistance (Re)		1.85Ω+1.85Ω	3.7Ω+3.7Ω	1.85Ω+1.85Ω	3.7Ω+3.7Ω
Inductance (Le) 1kHz/20kHz		2.39mH/1.02mH	3.79mH/1.93mH	2.41mH/1.02mH	3.85mH/1.92mH
Free Air Resonance (Fs)		29Hz	31Hz	28Hz	31Hz
Equivalent Stiffness (Vas)		26L (0.92 ft ³)	21L (0.75 ft ³)	43L (1.5 ft ³)	38L (1.5 ft ³)
Mechanical Q (Qms)		8.7	7.9	8.5	7.9
Electrical Q (Qes)		0.53	0.57	0.50	0.57
Total Q (Qts)		0.50	0.53	0.47	0.53
Xmax ₁₀ (One-Way Xmax @ 10% Distortion)		20 mm	20 mm	20 mm	20 mm
Mechanical Excursion, Peak-to-Peak		70mm	70mm	72mm	72mm
Gap Height (Hag)		10 mm	10 mm	10 mm	10 mm
Coil Height (Hvc)		44mm	44mm	44mm	44mm
Cone Area (Sd)		332 cm ²	332 cm ²	480 cm ²	480 cm ²
Voice Coil Diameter		65 mm (2.6")	65 mm (2.6")	65 mm (2.6")	65 mm (2.6")
Magnet Weight		128 oz	128 oz	144 oz	144 oz

Note: All specifications are subject to change without notice

All T/S parameters measured/calculated with voice coils connected in series, after break-in.

* This commonly misunderstood specification should not be used as a reference for subwoofer output capability.

** Based upon 3/4" (19mm) baffle thickness, with opening cut approximately to gasket inner diameter

Caractéristiques et spécifications		Type-R			
		SWR-1023D	SWR-1043D	SWR-1223D	SWR-1243D
Features					
Taille		10 po	10 po	12 po	12 po
Puissance admissible (efficace/de crête)		600W/1800W	600W/1800W	600W/1800W	600W/1800W
Plage de puissance (efficace)		300W-600W	300W-600W	300W-600W	300W-600W
Réponse en fréquence (Hz)		26Hz-200Hz	26Hz-200Hz	24Hz-200Hz	24Hz-200Hz
Membrane	Matériau	Pâte renforcée de Kevlar			
	Conception	2 pièce parabolique			
Suspension	Matériau	Santoprene ^{MD} moulé par injection			
	Conception	Multibourrelets à amplitude élevée (brevet en instance)			
Centreur	Matériau	Nomex ^{MD}			
	Conception	Progressif			
Bobine	Matériau	Fil résistant jusqu'à 180°C, sur forme de aluminium à sillon hélicoïdal			
	Conception	4 couches, double bobine			
Moteur	Géométrie de pièce polaire	Moteur à courbe complexe (brevet n° 6,639,993)			
	Configuration	Manchon de court-circuit integre avec transfer de chalur VC a ventilation radiale (brevet n° 7,634,101)			
Aimant	Matériau	Haut-Parleur, Strontium Ferrite			
	Conception	Assemblage d'aimant segmenté, 10 pièce			
Bâti	Matériau	Aluminium moulé			
	Conception	Bâti externe à ventilation périmétrique (brevet en instance)			
Bornes	Répartition	Un côté			
	Conception	Solide, calibre 8, à presion avec boîtier, cavalier à fiche banane			
Fils conducteurs	Conception	Intégration au centreur à renforcée (brevet n° 6,810,988)			
Joint d'étanchéité	Conception	Système d'étanchéité à montage dissimulé et pret à recevoir une grille intégrée (brevet en instance)			
Enceinte					
Profondeur de montage		149 mm (5.875po)	149 mm (5.875po)	162 mm (6.375po)	162 mm (6.375po)
Diamètre de montage - montage avant		231 mm (9.1po)	231 mm (9.1po)	275 mm (10.9po)	275 mm (10.9po)
Déplacement - montage avant**		0.080 pi ³	0.080 pi ³	0.100 pi ³	0.100 pi ³
Volume ajouté - montage inversé**		0.055 pi ³	0.055 pi ³	0.090 pi ³	0.090 pi ³
Types d'enceintes recommandés		Sealed, Vented, Bandpass			
Volume d'enceinte close (brut)		0.5-1.0 pi ³	0.5-1.0 pi ³	0.65-1.25 pi ³	0.65-1.25 pi ³
Enceinte close optimale	Dimensions extérieures	12.5po x 12.5po x 10po	12.5po x 12.5po x 10po	14.5po x 14.5po x 10.5po	14.5po x 14.5po x 10.5po
	Volume intérieur brut	0.60 pi ³	0.60 pi ³	0.90 pi ³	0.90 pi ³
	Volume intérieur net***	0.50 pi ³	0.50 pi ³	0.75 pi ³	0.75 pi ³
	F ₃ , Q _{tc}	43 Hz, 0.90	46 Hz, 0.90	44 Hz, 0.90	43 Hz, 0.90
Volume d'enceinte à événement (brut)		0.8-1.5 pi ³	0.8-1.5 pi ³	1.0-2.0 pi ³	1.0-2.0 pi ³
Enceinte à événement optimale	Dimensions extérieures	12.5po x 12.5po x 20.5po	12.5po x 12.5po x 20.5po	13.5po x 13.5po x 24po	13.5po x 13.5po x 24po
	Volume intérieur brut	1.4 pi ³	1.4 pi ³	1.9 pi ³	1.9 pi ³
	Aire de l'événement (dimensions)	11 po ² (11po x 1po)	11 po ² (11po x 1po)	15 po ² (12po x 1.25po)	15 po ² (12po x 1.25po)
	Longueur de l'événement	18.5po	18.5po	22po	22po
	Déplacement de l'événement	0.24 pi ³	0.24 pi ³	0.29 pi ³	0.29 pi ³
	Volume intérieur net (V _b)***	1.1 pi ³	1.1 pi ³	1.5 pi ³	1.5 pi ³
	F ₃ , crête, F _b	26Hz, 4.2dB, 35Hz	28Hz, 4.5dB, 35Hz	27Hz, 4.2dB, 33Hz	27Hz, 3.9dB, 33Hz
Paramètres électromécaniques#					
Impédance nominale		2Ω+2Ω	4Ω+4Ω	2Ω+2Ω	4Ω+4Ω
Réponse en fréquence		26 - 200Hz	26 - 200Hz	24 - 200Hz	24 - 200Hz
Sensibilité (NPA @ 1 W / 1 m)*		83dB	83dB	85dB	85dB
Résistance CC de la bobine (Re)		1.85Ω+1.85Ω	3.7Ω+3.7Ω	1.85Ω+1.85Ω	3.7Ω+3.7Ω
Inductance (Le) 1 kHz / 20 kHz		2.39mH/1.02mH	3.79mH/1.93mH	2.41mH/1.02mH	3.85mH/1.92mH
Résonance à l'air libre (Fs)		29Hz	31Hz	28Hz	31Hz
Raideur équivalente (Vas)		26L (0.92 pi ³)	21L (0.75 pi ³)	43L (1.5 pi ³)	38L (1.5 pi ³)
Q mécanique (Qms)		8.7	7.9	8.5	7.9
Q électrique (Qes)		0.53	0.57	0.50	0.57
Q total (Qts)		0.50	0.53	0.47	0.53
Xmax ₁₀ (à sens unique Xmax @ 10% Distorsion)		20mm	20mm	20 mm	20 mm
Déplacement mécanique, crête à crête		70mm	70mm	72mm	72mm
Hauteur de l'écartement (Hag)		10 mm	10 mm	10 mm	10 mm
Hauteur de la bobine (Hvc)		44mm	44mm	44mm	44mm
Surface du diaphragme (Sd)		332 cm ²	332 cm ²	480 cm ²	480 cm ²
Diamètre de la bobine		65 mm (2.6 po)	65 mm (2.6 po)	65 mm (2.6 po)	65 mm (2.6 po)
Poids de l'aimant		128 oz	128 oz	144 oz	144 oz

Notes:

Remarque : Les spécifications peuvent changer sans préavis.

Paramètres T/S mesurés/calculés avec bobines reliées en série, après rodage.

* Ne pas utiliser cette spécification souvent mal comprise comme référence pour la puissance du haut-parleur d'extrêmes graves.

** Panneau de 0.75 po (19 mm) d'épaisseur, ouverture correspondant environ au diamètre intérieur du joint d'étanchéité.

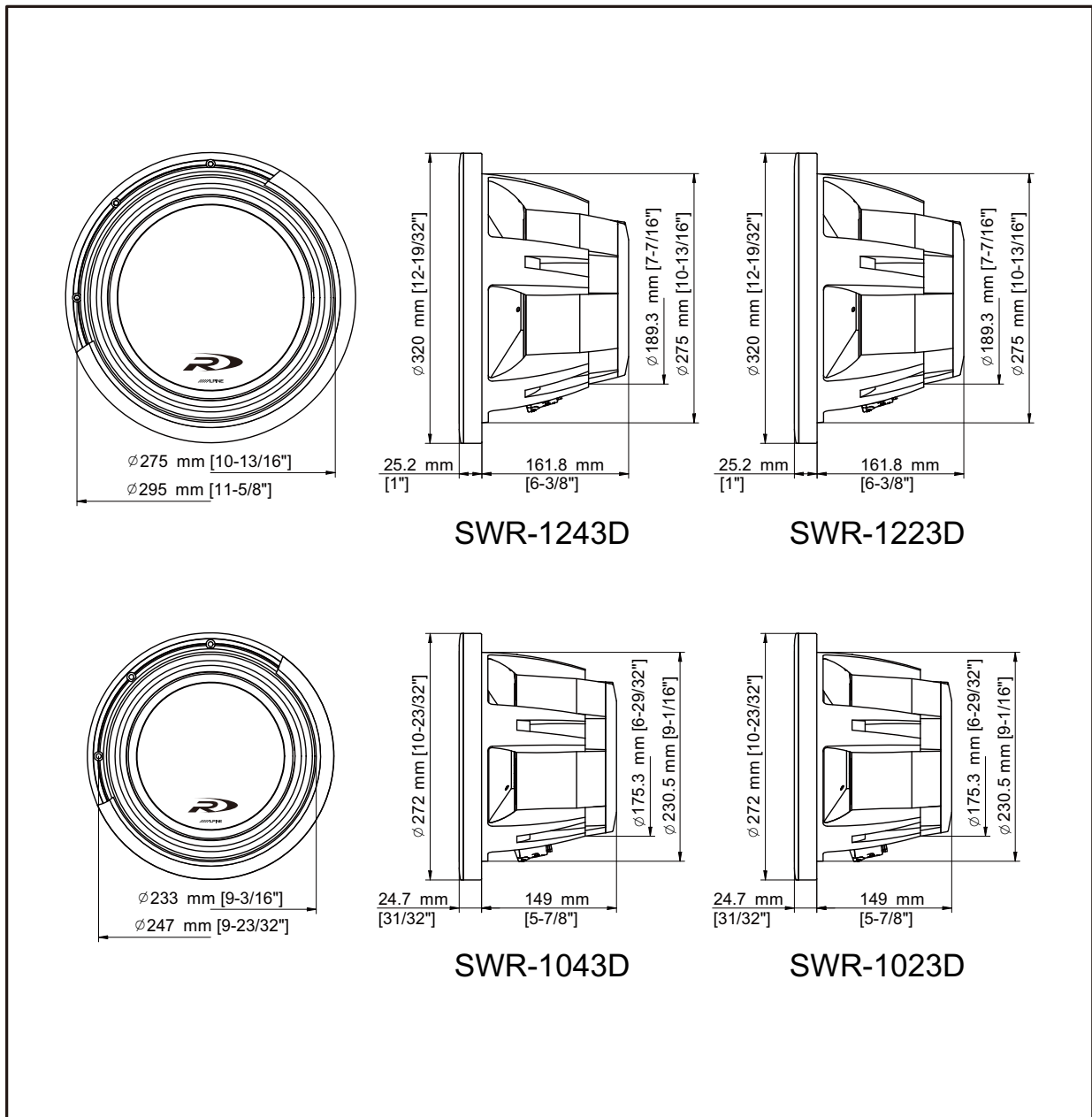

ALPINE ELECTRONICS, INC.
Tokyo office: 1-1-8 Nishi Gotanda,
Shinagawa-ku, Tokyo 141, Japan
Tel: (03) 3494-1101

ALPINE ELECTRONICS OF AMERICA, INC.
19145 Gramercy Place, Torrance,
California 90501, U.S.A.
Tel: (310) 326-8000

ALPINE ELECTRONICS OF CANADA, INC.
777 Supertest Road, Toronto,
Ontario M3J 2M9, Canada
Tel: (416) 736-6211

ALPINE ELECTRONICS OF AUSTRALIA PTY. LTD.
6-8 Fiveways Boulevard Keysborough,
Victoria 3173, Australia
Tel: 61 (3) 9769-0000

ALPINE ELECTRONICS DE ESPAÑA, S.A.
Portal de Gamarra 36, Pabellón 32, 01013
Vitoria (Alava). Apdo: 133, Spain
Tel: 34 (945) 283588

ALPINE ELECTRONICS GmbH
Frankfurter Ring 117, 80807 Monchen
Germany
Tel: 089-32 42 640

ALPINE ELECTRONICS MANUFACTURING OF EUROPE
H-2051 Biatorbagy, orfzag ut. 2, Hungary
Tel: 36 (23) 311-923

ALPINE ELECTRONICS OF U.K., LTD.
13 Tanners Drive, Blakelands, Milton Keynes,
Mk 14 5BU, U.L.
Tel: 44 (1908) 611556

ALPINE ELECTRONICS FRANCE S.A.R.L.
98, Rue de la Bella Etoile, Z.I. Paris Nord II
B.P. 50016, 95945, Roissy, C.D.G. Cédex,
France
Tel: 33 (1) 4863-8989

ALPINE ITALIA S.p.A.
Viale C. Colombo 8, 20090 Trezzano Sul
Naviglio, Italy
Tel: 39 (02) 484781

Printed in CHINA