



Blackbird Docking Adapter PMD-DOK2

INSTALLATION/OWNER'S MANUAL
Please read before using this equipment

INSTALLATIONS- UND BEDIENUNGSANLEITUNG

Bitte vor Verwendung des Produktes lesen

MANUEL D'INSTALLATION/D'UTILISATION

Veuillez lire ce manuel avant d'utiliser ce matériel

MANUALE DI ISTRUZIONI/GUIDA ALL'INSTALLAZIONE

Leggere il manuale prima di usare l'apparato

MANUAL DE INSTALACIÓN/DEL USUARIO

Lea el manual antes de utilizar este equipo

INSTALLATIE/GEbruikersHANDLEIDING

Lees aub alvorens dit apparaat te gebruiken

INSTALLATIONS-/ANVÄNDARMANUAL

Läs detta noga innan du använder utrustningen

INSTALLATIONS/BRUGERHÅNDBOG

Læses før produktet tages i brug



УСТАНОВКА/РУКОВОДСТВО ПОЛЬЗОВАТЕЛЯ

Внимательно прочитайте перед использованием оборудования

Points to Observe for Safe Usage

- Read this manual carefully before starting operation and use this system safely. We cannot be held responsible for problems resulting from failure to observe the instructions in this manual.
- This manual uses various pictorial displays to show how to use this product safely and to avoid harm to yourself and others and damage to your property. Here is what these pictorial displays mean. Understanding them is important for reading this manual.

- **Meaning of displays**

 Warning	This label is intended to alert the user to the presence of important operating instructions. Failure to heed the instructions will result in severe injury or death.
 Caution	This label is intended to alert the user to the presence of important operating instructions. Failure to heed the instructions can result in injury or material damage.

Warning

DO NOT DISASSEMBLE OR ALTER.

Doing so may result in an accident, fire or electric shock.

USE ONLY IN CARS WITH A 12 VOLT NEGATIVE GROUND.

(Check with your dealer if you are not sure.) Failure to do so may result in fire, etc.

DO NOT SPLICE INTO ELECTRICAL CABLES.

Never cut away cable insulation to supply power to other equipment. Doing so will exceed the current carrying capacity of the wire and result in fire or electric shock.

DO NOT INSTALL IN LOCATIONS WHICH MIGHT HINDER VEHICLE OPERATION, SUCH AS THE STEERING WHEEL OR GEARSHIFT.

Doing so may obstruct forward vision or hamper movement etc. and result in serious accident.

DO NOT ALLOW CABLES TO BECOME ENTANGLED IN SURROUNDING OBJECTS.

Arrange wiring and cables in compliance with the manual to prevent obstructions when driving. Cables or wiring that obstruct or hang up on places such as the steering wheel, gear lever, brake pedals, etc. can be extremely hazardous.

MAKE THE CORRECT CONNECTIONS.

Failure to make the proper connections may result in fire or product damage.

Caution

USE SPECIFIED ACCESSORY PARTS AND INSTALL THEM SECURELY.

Be sure to use only the specified accessory parts. Use of other than designated parts may damage this unit internally or may not securely install the unit in its place. This may cause parts to become loose resulting in hazards or product failure.

DO NOT INSTALL IN LOCATIONS WITH HIGH MOISTURE OR DUST.

Avoid installing the unit in locations with high incidence of moisture or dust. Moisture or dust that penetrates into this unit may result in product failure.

HAVE THE WIRING AND INSTALLATION DONE BY EXPERTS.

The wiring and installation of this unit require special technical skill and experience. To ensure safety always contact the dealer where you purchased this product to have the work done.

ARRANGE THE WIRING SO IT IS NOT CRIMPED OR PINCHED BY A SHARP METAL EDGE.

Route the cables and wiring away from moving parts (like the seat rails) or sharp or pointed edges. This will prevent crimping and damage to the wiring. If wiring passes through a hole in metal, use a rubber grommet to prevent the wire's insulation from being cut by the metal edge of the hole.

Installation

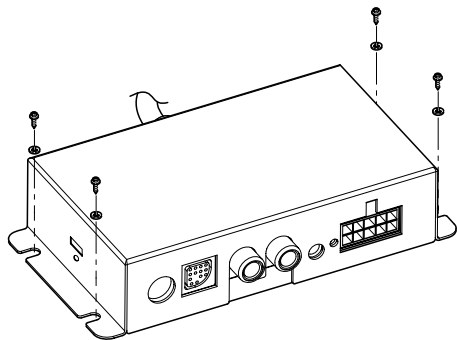

- To protect against vehicle noise, leave a space of 10 to 20 cm between the vehicle wiring and wiring for the Docking Adapter when installing.
- The Docking Adapter should be mounted in a convenient location using the mounting screws provided.

Connections

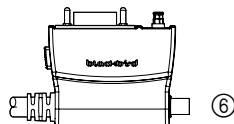
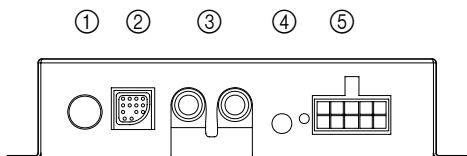
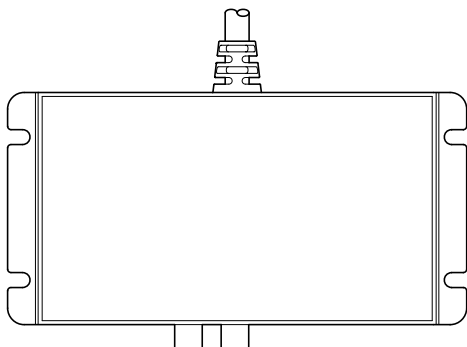

1. ANTENNA INPUT (OPTIONAL)

FM antenna input (RDS-TMC traffic tuner reception).
Optional film antenna (KAE-500FM) available. See your Alpine dealer for details.

2. DISPLAY (RGB Output)

Connects to the display connector of Alpine Multimedia Stations.

3. AUDIO OUTPUT

Connects to AUX input of Alpine Multimedia Stations (RCA not included).

4. MICROPHONE

External microphone input.

5. POWER

Connects 10-pin power input harness.

6. GPS ANTENNA

GPS antenna is located on the connector to the Blackbird.

Wiring Diagram With IVA-D106R

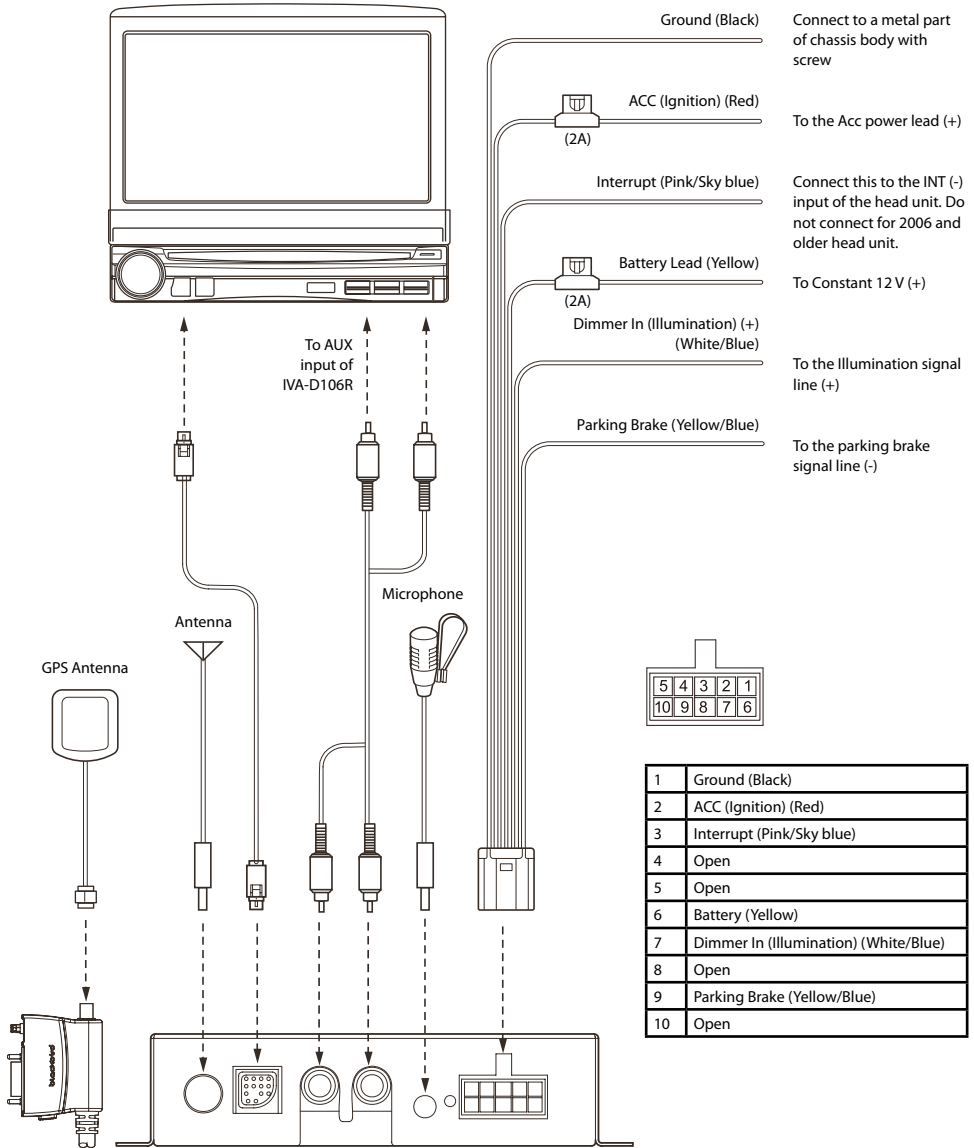

1	Ground (Black)
2	ACC (Ignition) (Red)
3	Interrupt (Pink/Sky blue)
4	Open
5	Open
6	Battery (Yellow)
7	Dimmer In (Illumination) (White/Blue)
8	Open
9	Parking Brake (Yellow/Blue)
10	Open

Operating Blackbird from the Multimedia Station (using IVA-D106R as an example)

1. Connect Blackbird to the Docking Adapter, with Blackbird turned off.
2. Power on the Multimedia Station and select Navigation as source.

To listen to music from Blackbird

3. Press source and select AUX as input.
4. Press V.SEL and select Navigation as video source.

• Using V.SEL, you can still use functions of the Multimedia Station while Blackbird is on the screen.

• Blackbird's music feature is also available from the Navi menu. See Blackbird Owner's Manual for more details.

Note: Please ensure your Blackbird is turned OFF before connecting to the docking adapter. In the event navigation does not display on the Multimedia Station screen, please reset the Blackbird.

Specifications



- External dimensions.....118 (w) x 30 (h) x 70 (d) mm
- Weight 360 g
- Included in the box:
 - PMD-DOK2 Docking Adapter..... 1
 - 10 pin Power harness..... 1
 - 13 pin RGB Video cable..... 1
 - Audio cable..... 1
 - Mounting screws 4
 - Installation/Owner's Manual..... 1
- Product specifications and appearance are subject to change without notice for the purpose of improvement.

Features

- Navigation map display output to Multimedia Station
- Full Touch Control with compatible Multimedia Station
- Voice guidance output
- Stereo MP3/WMA audio output

Confirming Proper Installation

The vehicle connections screen allows you to ensure proper installation of PMD-DOK2.

1. Touch NAVI. The Multimedia Station will display the Blackbird screen.
2. Touch MAIN MENU .
3. Touch INFORMATION .
4. Select VEHICLE CONNECTIONS. The connection status will appear on the screen.

Illumination - Toggle the parking lamp switch on and off to confirm this connection. This will allow the navigation display to change between night and day mode.

Parking Brake - Toggle the parking brake on and off to confirm this connection. This will allow access to the Edit and Setup menu while the vehicle is parked.

Additional On-Screen Buttons

When Blackbird is docked, two additional on-screen buttons allow you to conveniently access system features.



Touching this button will give you access to the Multimedia Station's display control.

Note: If left idle for more than 5 seconds, the system will automatically return to the Blackbird navigation screen.



Touching this button will display the Blackbird's music screen. Refer to the Blackbird Owner's Manual for help using the music functions.



In Case of Difficulty

If you encounter a problem, please turn the power off, then on again. If the unit is still not functioning normally, please review the items in the following checklist. This guide will help you isolate the problem. Otherwise make sure the rest of your system is properly connected, or consult your authorised Alpine dealer.

No function or display.

- Blown fuse.
 - Check the fuse on the battery and ACC lead of the dock; replace with the proper value fuse (2 A blade fuse) if necessary.

Touch screen not working.

- Monitor is not touch panel enabled.
 - The touch screen feature will work only with an Alpine touch panel monitor.
- Connection failure
 - In some vehicles it may be necessary to connect the Multimedia Station's remote turn-on lead (blue/white) to the ignition lead of the dock.
- Not supported
 - The docking adapter does not support PMD-B100 or PMD-B100P. For those units please use PMD-DOK1.

No GPS signal.

- GPS antenna not connected.
 - Connect the provided GPS antenna. For best reception, ensure that it has a good open view to the sky and make sure the antenna is not covered (obstructed) by any metallic surface or object.

Cannot access certain functions.

- Certain functions are disabled while driving.
 - Certain menu and functions are disabled while driving. Pull over and engage the parking brake to enable these features.
- Certain functions are disabled in docking mode.
 - Remove the Blackbird from the dock, and power it on in the cradle or in standalone mode to enable these functions.

Unable to receive traffic information.

- Antenna disabled.
 - If using a stock antenna with an active splitter system, it might be necessary to use the Multimedia Station's remote turn-on lead (blue/white) instead of the power antenna out wire to continuously activate the power antenna and/or antenna booster.
- No antenna.
 - Make sure an FM antenna is properly connected; replace the antenna or cable if necessary.

Bluetooth Handsfree is not working.

- Interrupt icon pops up whenever there is a call.
 - Please go into the Setup Menu of your Alpine Multimedia Station. In System Setup, change Bluetooth setting to NAV. For 2006 and older head units without a Bluetooth setting DO NOT connect the Interrupt wire.
- No Audio can be heard during a call.
 - Please make sure the Docking Adapter is connected to the AUX input of your Alpine Multimedia Station. For 2006 and older head units make sure to select AUX as source, and answer with your phone.