

FOR CAR USE ONLY/NUR FÜR AUTOMOBIL GEBRAUCH/POUR APPLICATION AUTOMOBILE UNIQUEMENT/  
PARA USO EN AUTOMÓVILES/SOLO PER L'UTILIZZO IN AUTOMOBILE/ENDAST FÖR BILBRUK

# ALPINE®

## DVD-VIDEO Player DVE-5207

**MP3**



- **OWNER'S MANUAL**  
Please read before using this equipment.
- **BEDIENUNGSANLEITUNG**  
Lesen Sie diese Bedienungsanleitung bitte vor  
Gebrauch des Gerätes.
- **MODE D'EMPLOI**  
Veuillez lire avant d'utiliser cet appareil.
- **MANUAL DE OPERACIÓN**  
Léalo antes de utilizar este equipo.
- **ISTRUZIONI PER L'USO**  
Si prega di leggere prima di utilizzare  
l'attrezzatura.
- **ANVÄNDARHANDLEDNING**  
Innan du använder utrustningen bör du läsa  
igenom denna användarhandledning.

**ALPINE ELECTRONICS MARKETING, INC.**  
1-1-8 Nishi Gotanda,  
Shinagawa-ku,  
Tokyo 141-0031, Japan  
Phone 03-5496-8231

**ALPINE ELECTRONICS OF AMERICA, INC.**  
19145 Gramercy Place, Torrance,  
California 90501, U.S.A.  
Phone 1-800-ALPINE-1 (1-800-257-4631)

**ALPINE ELECTRONICS OF CANADA, INC.**  
777 Superfund Road, Toronto,  
Ontario M3J 2M9, Canada  
Phone 1-800-ALPINE-1 (1-800-257-4631)

**ALPINE ELECTRONICS OF AUSTRALIA PTY. LTD.**  
161-165 Princes Highway, Hallam  
Victoria 3803, Australia  
Phone 03-8787-1200

**ALPINE ELECTRONICS GmbH**  
Frankfurter Ring 117,  
80807 München, Germany  
Phone 089-32 42 640

**ALPINE ELECTRONICS OF U.K. LTD.**  
Alpine House  
Fletchamstead Highway, Coventry CV4 9TW, U.K.  
Phone 0870-33 33 763

**ALPINE ELECTRONICS FRANCE S.A.R.L.**  
(RCS PONTOISE B 338 101 280)  
98, Rue de la Belle Etoile, Z.I. Paris Nord II,  
B.P. 50016, 95945 Roissy Charles de Gaulle  
Cedex, France  
Phone 01-48638989

**ALPINE ITALIA S.p.A.**  
Viale C. Colombo 8, 20090 Trezzano  
Sul Naviglio (MI), Italy  
Phone 02-484781

**ALPINE ELECTRONICS DE ESPAÑA, S.A.**  
Portal de Gamarra 36, Pabellón, 32  
01013 Vitoria (Alava)-APDO 133, Spain  
Phone 945-283588

EN

DE

FR

ES

IT

SE

# Contents

## Operating Instructions

### WARNING

<b>WARNING</b> .....	<b>3</b>
<b>CAUTION</b> .....	<b>3</b>
<b>PRECAUTIONS</b> .....	<b>4</b>
<b>Discs playable on this unit</b> .....	<b>5</b>

### Getting Started

When Using the Remote Control .....	7
Battery Replacement .....	7
Turning Power On and Off .....	8
Initial System Start-Up .....	9
Loading and Unloading Discs .....	9
Setting the Wallpaper .....	9

### DVD/Video CD

Playing DVD/Video CD .....	10
Stopping Playback (PRE-STOP) .....	10
Stopping Playback .....	10
Fast-forwarding/Fast-reversing .....	10
Finding the Beginning of Chapters or Tracks ...	11
Playing Still Frames (pausing) .....	11
Frame-by-frame Playback .....	11
Slow Motion Playback .....	11
Searching by Title Number (DVD only) .....	11
Searching Directly by Chapter or Track Number ...	11
Chapter/Track/Title Repeat Playback .....	12
Switching the Audio Tracks .....	12
Switching the Angle (DVD only) .....	12
Switching the Subtitles (subtitle language) (DVD only) .....	12
Displaying the Disc Status (DVD only) .....	13
Displaying the Disc Status (Video CD only) ....	13

### CD

Playback .....	14
M.I.X. (Random Play) .....	14
Repeat Play .....	14

### MP3

Playback .....	15
Selecting Folders .....	15
M.I.X. (Random Play) .....	15
Repeat Play .....	15
Folder/File Name Search .....	15
About MP3 .....	16

### DVD Setup

DVD Setup Operation .....	17
Setting the Language .....	17
Setting the TV Screen .....	17
Setting the Country Code .....	18
Setting the Rating Level (Parental Lock) .....	18
Setting the Digital Output .....	19

### Custom Setup

Custom Setup Operation .....	20
Setting the CD Play Mode .....	20
Setting the Video CD Play Mode .....	20
Setting the Pause Mode .....	20
Setting the Downmix Mode .....	20

### Information

About DVDs .....	21
Terminology .....	22
List of Language Codes .....	23
List of Country Codes .....	24
In Case of Difficulty .....	26
Specifications .....	27

---

# Installation and Connections

## WARNING

---

<b>WARNING .....</b>	<b>28</b>
<b>CAUTION .....</b>	<b>28</b>
<b>PRECAUTIONS .....</b>	<b>28</b>
Installation .....	29
Connections .....	32
System Example .....	33
Operating the DVE-5207 Video Player .....	35

---

---

# Operating Instructions

## WARNING

### WARNING

This symbol means important instructions. Failure to heed them can result in serious injury or death.

---

#### **DO NOT WATCH VIDEO WHILE DRIVING.**

Watching the video may distract the driver from looking ahead of the vehicle and cause an accident.

---

#### **DO NOT OPERATE ANY FUNCTION THAT TAKES YOUR ATTENTION AWAY FROM SAFELY DRIVING YOUR VEHICLE.**

Any function that requires your prolonged attention should only be performed after coming to a complete stop. Always stop the vehicle in a safe location before performing these functions. Failure to do so may result in an accident.

---

#### **KEEP THE VOLUME AT A LEVEL WHERE YOU CAN STILL HEAR OUTSIDE NOISE WHILE DRIVING.**

Failure to do so may result in an accident.

---

#### **MINIMIZE DISPLAY VIEWING WHILE DRIVING.**

Viewing the display may distract the driver from looking ahead of the vehicle and cause an accident.

---

#### **DO NOT DISASSEMBLE OR ALTER.**

Doing so may result in an accident, fire or electric shock.

---

#### **USE ONLY IN CARS WITH A 12 VOLT NEGATIVE GROUND.**

(Check with your dealer if you are not sure.) Failure to do so may result in fire, etc.

---

#### **KEEP SMALL OBJECTS SUCH AS BATTERIES OUT OF THE REACH OF CHILDREN.**

Swallowing them may result in serious injury. If swallowed, consult a physician immediately.

---

#### **USE THE CORRECT AMPERE RATING WHEN REPLACING FUSES.**

Failure to do so may result in fire or electric shock.

---

#### **DO NOT BLOCK VENTS OR RADIATOR PANELS.**

Doing so may cause heat to build up inside and may result in fire.

---

#### **USE THIS PRODUCT FOR MOBILE 12V APPLICATIONS.**

Use for other than its designed application may result in fire, electric shock or other injury.

---

#### **DO NOT PLACE HANDS, FINGERS OR FOREIGN OBJECTS IN INSERTION SLOTS OR GAPS.**

Doing so may result in personal injury or damage to the product.

---

### CAUTION

This symbol means important instructions. Failure to heed them can result in injury or material property damage.

---

#### **HALT USE IMMEDIATELY IF A PROBLEM APPEARS.**

Failure to do so may cause personal injury or damage to the product. Return it to your authorized Alpine dealer or the nearest Alpine Service Centre for repairing.

---

#### **DO NOT MIX NEW BATTERIES WITH OLD BATTERIES. INSERT WITH THE CORRECT BATTERY POLARITY.**

When inserting the batteries, be sure to observe proper polarity (+ and -) as instructed. Rupture or chemical leakage from the battery may cause fire or personal injury.

---

#### **KEEP FINGERS AWAY WHILE THE MOTORIZED FRONT PANEL OR MOVING MONITOR IS IN MOTION.**

Failure to do so may result in personal injury or damage to the product.

# PRECAUTIONS

## Product Cleaning

Use a soft dry cloth for periodic cleaning of the product. For more severe stains, please dampen the cloth with water only. Anything else has the chance of dissolving the paint or damaging the plastic.

## Temperature

Do not operate your unit in ambient temperature above +60°C (+140°F) or below -10°C (+14°F).

## Moisture Condensation

You may notice the disc playback sound wavering due to condensation. If this happens, remove the disc from the player and wait about an hour for the moisture to evaporate.

## Damaged Disc

Do not attempt to play cracked, warped, or damaged discs. Playing a bad disc could severely damage the playback mechanism.

## Maintenance

If you have problems, do not attempt to repair the unit yourself. Return it to your Alpine dealer or the nearest Alpine Service Station for servicing.

## Never Attempt the Following

Do not grip or pull out the disc while it is being pulled back into the player by the automatic reloading mechanism.

Do not attempt to insert a disc into the unit when the unit power is off.

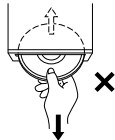

## Inserting Discs

Your player accepts only one disc at a time for playback. Do not attempt to load more than one disc.

Make sure the label side is facing up when you insert the disc.

Press  to eject any disc that is inserted incorrectly.

Playing a disc while driving on a very bumpy road may result in skips, but this will not scratch the disc or damage the player.

## New Discs

As a protective measure to prevent the disc from jamming, press  to eject any disc with irregular surface or inserted incorrectly.

When a new disc is inserted into the player and ejected after initial loading, using your finger, feel around the inside of the centre hole and outside edge of the disc. If you feel any small bumps or irregularities, this could inhibit proper loading of the disc. To remove the bumps, rub the inside edge of the hole and outside edge of the disc with a ball-point pen or other such instrument, then insert the disc again.

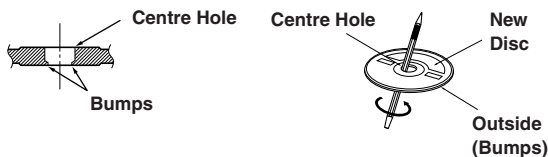

## Irregular Shaped Discs

Be sure to use round shaped discs only for this unit and never use any special shaped discs.

Use of special shaped discs may cause damage to the mechanism.

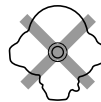

## Installation Location

Make sure the DVE-5207 will not be installed in a location subjected to:

- Direct sun and heat
- High humidity and water
- Excessive dust
- Excessive vibrations

## Correct Handling

Do not drop the disc while handling. Hold the disc so you will not leave fingerprints on the surface. Do not affix tape, paper, or gummed labels to the disc. Do not write on the disc.



INCORRECT

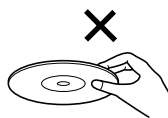

CORRECT



CORRECT



## Disc Cleaning

Fingerprints, dust, or soil on the surface of the disc could cause the DVD player to skip. For routine cleaning, wipe the playing surface with a clean, soft cloth from the centre of the disc to the outer edge. If the surface is heavily soiled, dampen a clean, soft cloth in a solution of mild neutral detergent before cleaning the disc.



## Disc Accessories

There are various accessories available on the market for protecting the disc surface and improving sound quality. However, most of them will influence the thickness and/or diameter of the disc. Using such accessories can cause operational problems. We recommend not using these accessories on discs played in Alpine DVD players.

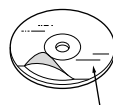

Transparent Sheet

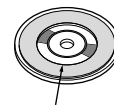

Disc Stabilizer

# Discs playable on this unit

## Playable Discs

The discs listed below can be played on this unit.

	Mark (logo)	Recorded content	Disc size	Max. playing time
DVD Video		Audio + Video (Moving pictures)	12 cm*	One-sided disc Approx. 4 hours
				Two-sided disc Approx. 8 hours
			8 cm	One-sided disc Approx. 80 Minutes
				Two-sided disc Approx. 160 Minutes
Video CD		Audio + Video (Moving pictures)	12 cm	Approx. 74 Minutes
			8 cm	Approx. 20 Minutes
Music CD		Audio	12 cm	Approx. 74 Minutes
			8 cm (CD single)	Approx. 20 Minutes

\* Two-layer DVD disc compatible

## Discs that cannot be played

DVD-ROMs, DVD-RAMs, DVD + Rs, DVD + RWs, CD-ROMs (excluding MP3 files), photo CDs, etc.

## DVD region number (playable region number)

This DVD player will play back any disc whose region number is 2 (or All). DVDs with a region number other than those listed below, cannot be played on this DVD player.



## Video CDs

This DVD unit is compatible with playback control (PBC) compatible video CDs (version 2.0).

“PBC” is a function by which you can use menu screens recorded on the disc to find the scene you want to watch and view various types of information in dialog style.

## Using compact discs (CD/CD-R/CD-RW)

If you use unspecified compact discs, correct performance cannot be guaranteed.

You can play CD-Rs (CD-Recordable)/CD-RWs (CD-ReWritable) which have been recorded only on audio devices. You can also play CD-Rs/CD-RWs containing MP3 formatted audio files.

- Some of the following discs may not play on this unit:
  - Flawed discs, discs with fingerprints, discs exposed to extreme temperatures or sunlight (e.g., left in the car or this unit), discs recorded under unstable conditions, discs on which a recording failed or a re-recording was attempted, copy-protected CDs which do not conform to the audio CD industry standard.
- Use discs with MP3 files written in a format compliant with ISO9660 level 1 or level 2. For details, see page 16.

To customers using CD-R/CD-RW

- If a CD-R/CD-RW cannot be played back, make sure the last recording session was closed (finalized).
- Finalize the CD-R/CD-RW if necessary, and attempt playback again.

## Tips for making your own CDs

The DVE-5207 plays DVD Video, Video CD, Audio CD and has a built in MP3 decoder.

The following information is designed to help you create your own music CDs (either Audio CD or MP3 encoded CD-R/RW files).

### What is the difference between an Audio and MP3 CD?

An Audio CD is the same format as the commercial CDs you buy in the store (also known as CD-DA). MP3 (MPEG-1 Audio Layer 3) is a data file that uses a compression scheme to reduce the size of the music file.\*

### Hybrid Audio CD and Data (MP3) CD-R/RW discs:

The DVE-5207 can read either sector on the disc. Choose CD-DA to play the CD audio section or MP3 to play the MP3 section.\*

*Continued*

### Multisession CD-R/RW:

Once a recording has been stopped, this is considered one session. If the disc is not closed (finalized), additional data may be added. Once this additional data has been recorded, this becomes a "multisession" CD. The DVE-5207 can only read multisession DATA Formatted discs (MP3 files - Not Audio CD files).

### Properly formatted MP3 Discs:

Use ISO9660 formatting to insure proper playback. You may use standard ISO naming Level 1 (8.3 DOS standard), Level 2 (32 characters) or Joliet (Windows or Macintosh long filenames) file naming conventions\*.

\*Please consult the Owner's manual for additional information.

#### On handling compact discs (CD/CD-R/CD-RW)

- Do not touch the surface.
- Do not expose the disc to direct sunlight.
- Do not affix stickers or labels.
- Clean the disc when it is dusty.
- Make sure that the disc is smooth and flat.
- Do not use commercially available disc accessories.

**Do not leave the disc in the car or the unit for a long time.**

**Never expose the disc to direct sunlight.**

Heat and humidity may damage the disc and you may not be able to play it again.

### Using DVD-Rs/DVD-RWs

- This unit is compatible only with discs recorded in the DVD-Video mode. Discs recorded in the DVD-VR mode cannot be played back.
- Note that discs not finalized (processed to enable to play on playback-only DVD players) cannot be played on this DVD player.
- Some discs may not play back, depending on the recording device. (This unit has a copy protection function. Discs copied illegally will not be played back. Some files recorded by a software using an improper recording system may be recognized as illegally copied.)
- In the following cases, the disc may not play on this unit: discs recorded by certain DVD recorders, certain irregular discs, flawed discs, dirty discs, when the pickup lens of this DVD player is dirty, or when moisture condensation has occurred inside the unit.
- Be sure to follow all cautions included with your DVD-Rs/DVD-RWs discs.
- Do not put stickers, seals, or tape on the label side of DVD-Rs/DVD-RWs.
- Compared to the regular discs, DVD-Rs/DVD-RWs are more affected by heat, moisture, and direct sunlight. If left in a car, etc., damage may occur and it might not play on this unit.

---

### Disc terminology

#### Title

If titles are programmed for the DVD, these are the largest units of division of the information recorded on the disc.

#### Chapter

Each Title may also be divided into smaller divisions, called chapters. These can be specific scenes or musical selections.

- *This product incorporates copyright protection technology that is protected by method claims of certain U.S. patents and other intellectual property rights owned by Macrovision Corporation and other rights owners. Use of this copyright protection technology must be authorized by Macrovision Corporation, and is intended for home and other limited viewing uses only unless otherwise authorized by Macrovision Corporation. Reverse engineering or disassembly is prohibited.*
- *Manufactured under license from Dolby Laboratories. "Dolby," "Pro Logic" and the double-D symbol are trademarks of Dolby Laboratories.*
- *"DTS" and "DTS2.0 + Digital Out" are trademarks of Digital Theater Systems, inc.*

# Getting Started

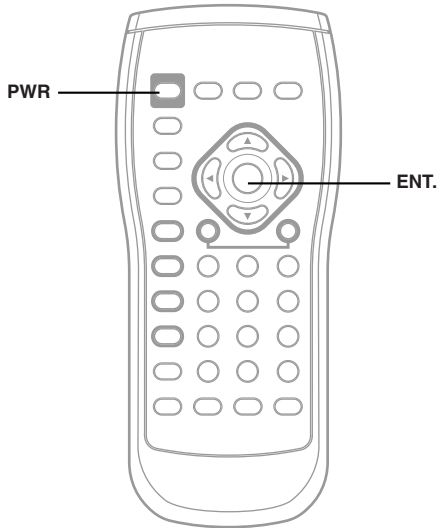

## When Using the Remote Control

- Point the remote control at the remote sensor within about 2 meters.
- It may not be possible to operate the remote control if the remote control sensor is exposed to direct sunlight.
- The remote control is a small, lightweight precision device. To avoid damage, short battery life, operational errors and poor response, observe the following.
  - Do not subject the remote control to excessive shock.
  - Do not put in a trouser pocket.
  - Keep away from food, moisture and dirt.
  - Do not place in direct sunshine.

## Battery Replacement

Battery type: CR2025 battery or equivalent.

### 1 Opening the battery case

Slide out the battery cover while firmly pressing in the direction of the arrow.

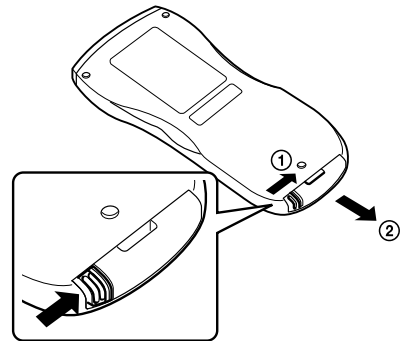

### 2 Replacing the battery

Put the battery in the case with the (+) indication upward as shown in the illustration.

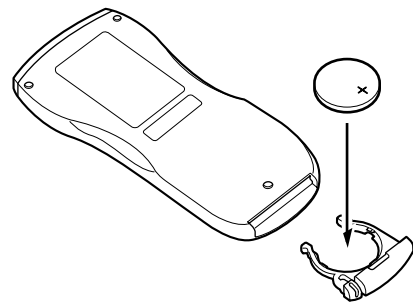

- Placing a battery in backwards way may cause a malfunction.

**Continued**



### 3 Closing the cover

Slide the cover as illustrated until a click is heard.

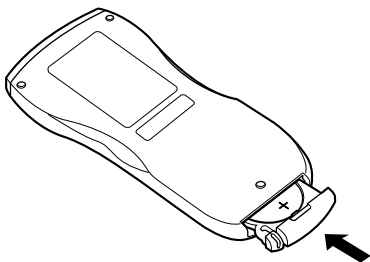

### Warning

**DO NOT OPERATE ANY FUNCTION THAT TAKES YOUR ATTENTION AWAY FROM SAFELY DRIVING YOUR VEHICLE.**

Any function that requires your prolonged attention should only be performed after coming to a complete stop. Always stop the vehicle in a safe location before performing these functions. Failure to do so may result in an accident.

## Turning Power On and Off

### Play Position Memory Function

If you turn power off or switch the ignition key to OFF during playback, playback will continue from the point where playback stopped when the power is turned ON again. The play position memory is cancelled when the disc is removed.

- 1 Press PWR of the remote control.**  
The power turns on.
- 2 To turn the power off, press PWR again.**

## Initial System Start-Up

Be sure to press the RESET button when using the unit for the first time, after changing the car battery, etc.

- 1 Turn off the unit power.
- 2 Press **RESET** with a ball-point pen or similar pointed object.

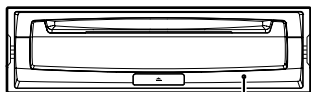

RESET

## Loading and Unloading Discs

Turn on the power before loading and unloading discs. (Refer to "Turning the Power On and Off" on page 8.)

### Loading discs

**Insert the disc with the label side facing upwards.**  
Once the disc is partially inserted, it is drawn in automatically. Playback starts.

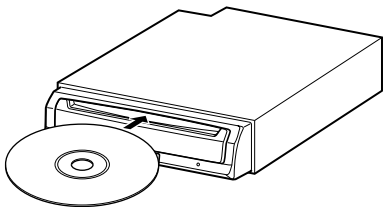

- If the ignition key is on ACC or ON, a disc can be inserted even when the power is OFF.
- For two-sided DVDs, play one side of the disc to the end, then unload the disc, turn it over and reload it to play the other side.
- Never insert map discs for navigation purposes as they could damage the equipment.
- If wrong disc, upside-down discs or dirty discs have been inserted, "DISC ERROR" is displayed. Press ▲ and eject the disc.

### Unloading discs

Press ▲.

Be sure to remove the disc.

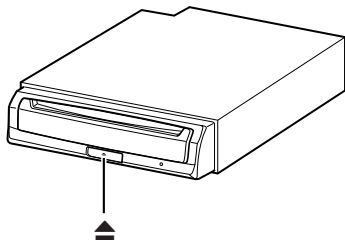

- If the disc is not removed within a few moments, it will be reloaded automatically.
- If the ignition key is set to ACC or ON, a disc can be removed even when the power is OFF. After removing the disc, the power turns OFF again automatically.
- During ACC OFF or while the disc is being loaded ("LOADING" is displayed), the disc will not be ejected even if you press ▲.

## Setting the Wallpaper

A data file downloaded from the ALPINE Owner's website is written to a CD-R/CD-RW disc, and automatically uploaded when the disc is inserted into the DVE-5207.

The wallpaper file can be saved and displayed only if the current disc is not playing back pictures or CD/MP3 audio.

- If several files are stored in a disc, only the first file will be stored on the unit.

### 1 Insert a CD-R/CD-RW disc containing data.

After sensing the disc, the DATA DOWNLOAD screen is displayed.

### 2 Press and hold ENT. for at least 2 seconds to change the wallpaper.

- Up to 2 files can be stored on this unit. If a third file is downloaded, the first file is overwritten and new one memorized.
- To change the wallpaper, press and hold ENT. for at least 2 seconds while displaying it.
- Even if the battery power cable is removed, the downloaded data is not cleared.

# DVD/Video CD

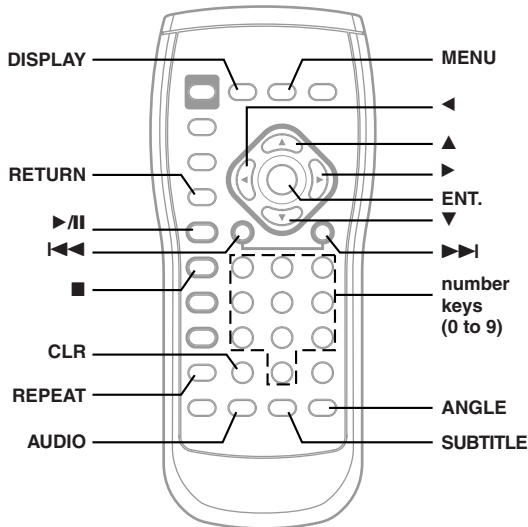

## Playing DVD/Video CD

### Caution

- Not all functions will operate for every DVD. See the individual DVD's instructions for details on the features supported.
- Fingerprints on a disc may adversely affect playback. If a problem occurs, remove the disc and check for fingerprints on the playback side. Clean the disc if necessary.
- When using the remote control, be careful to press one button at a time. Pressing multiple buttons at the same time may cause erroneous operation.
- If you switch the power or ignition key OFF during playback, playback will continue where you left off when you resume playback.
- If you try to perform an invalid operation (based on the type of disc being played), the following mark is displayed on the monitor screen: 
- DVE-5207 automatically changes the video output signal (NTSC or PAL), according to the disc. To set NTSC or PAL on the connected monitor, refer to the Owner's Manual of the monitor.

### Insert a disc with the label side facing up.

To load discs, see "Loading and Unloading Discs" on page 9. Playback starts.

- The reverse side of a double-sided DVD will not be played automatically. Remove the disc, turn it over, and reinsert it.
- It may take some time before playback starts after loading a disc.

## If a menu screen appears

On DVDs and video CDs with playback control (PBC), menu screens may appear automatically. If this happens, perform the operation described below to start playback.

- For many discs, the menu screen can also be displayed by pressing **MENU**.

### DVD menu

Press **▲**, **▼**, **◀** or **▶** to select the desired item, then press **ENT.**

- For some discs it is possible to select items directly from the menu screen using the **number keys** ("0" to "9").

### Video CD menu

Use the **number keys** ("0" to "9") to select the desired number, then press **ENT.**

- The menu screen does not appear when the PBC function is turned off. In this case, set **VCD PLAY MODE** to turn on the PBC function. For details, Refer to "Setting the Video CD Play Mode" (page 20).

## Stopping Playback (PRE-STOP)

Press **■** during playback to stop playback. That position is stored in memory.

- 1 Press **■** during playback.  
"PRE-STOP" is displayed.
  - 2 Press **►/II** in the PRE-STOP mode.  
Playback starts from the position at which it was stopped.
- For some discs, the position at which playback was stopped may not be accurate.

## Stopping Playback

Press **■** twice during playback.

"STOP" is displayed, and playback stops.

- Playback stops also when **■** is pressed for more than 2 seconds.
- Playback starts from the beginning when **►/II** is pressed while playback is stopped.

## Fast-forwarding/Fast-reversing

- 1 During playback, press and hold **I◀◀** (fast-reverse) or **▶▶I** (fast-forward).

When pressed for more than 1 second, the disc is forwarded/reversed at double speed.

When held in 5 more seconds, the disc is forwarded/reversed at 8 times the normal speed.

- 2 Release **I◀◀** or **▶▶I** to return to normal playback.

- No sound appears during fast-forward/fast-reverse.
- fast-forwarding/fast-reversing of only a track being played back can be made on the Video CD equipped with PBC (playback control).
- For DVDs and video CDs with playback control (PBC), the menu screen may reappear during fast-forwarding/fast-reversing.

---

## Finding the Beginning of Chapters or Tracks

---

During playback, press **◀◀** or **▶▶**.

The chapter/track switches each time the button is pressed, and playback of the selected chapter/track starts.

**▶▶**: Press this to start playback from the beginning of the following chapter or track.

**◀◀**: Press this to start playback from the beginning of the current chapter or track.  
Press **◀◀** repeatedly to start playback from the beginning of a previous chapter or track.

- Some DVDs do not have chapters.
- The beginning of a track may not be found on the Video CD equipped with PBC (playback control). Set VCD PLAY MODE to turn the PBC function off. Refer to "Setting the video CD Play Mode" (page 20).

### Supplementary explanation

"Chapters" are divisions of movies or musical selections on DVDs.

"Tracks" are divisions of movies or musical selections on video and music CDs.

---

## Playing Still Frames (pausing)

---

**1** During playback, press **▶/II**.

**2** Press **▶/II** to resume playback.

- No sound is played during the still mode.
- The image or sound may stop temporarily when playback starts from the pause mode. This is not a malfunction.

---

## Frame-by-frame Playback

---

**1** In the pause mode, press **◀◀** or **▶▶**.

The picture advances or reverses by one frame each time the button is pressed.

**2** Press **▶/II** to resume normal playback.

- No sound is played during frame-by-frame playback.
- For video CD, reverse frame-by-frame playback is not available.

---

## Slow Motion Playback

---

**1** Press and hold **◀◀** or **▶▶** while in the pause mode to set 1/8 normal speed slow motion playback mode/reverse slow motion playback mode. Hold for a further 5 seconds to set half speed.

**2** Release **◀◀** or **▶▶** to pause, and press **▶/II** to playback.

- No sound is played during slow motion playback/reverse slow motion playback.
- Slow playback/reverse slow playback is not available when playing back a slide show.
- 1/2, 1/8 are approximate speeds. The actual speed differs from disc to disc.
- For video CD, reverse slow motion playback is not available.

---

## Searching by Title Number (DVD only)

---

Use this function to easily find positions on the DVD using the DVD's title.

**1** When playback stops, input the number of the title you want to play using the number keys ("0" to "9").

**2** Press **ENT**.

Playback starts from the selected title number.

- This function cannot be used on discs on which no title numbers are recorded.
- Press **CLR** to delete the last digit in the title number. Press and hold **CLR** for at least 2 seconds to clear all title numbers.
- Press **RETURN** to cancel the title search mode and resume normal playback.
- The playback starts automatically for two digit title numbers even if **ENT**, in procedure 2 is not pressed.
- Playback starts from the beginning of the chapter/track number in the state of **PRE-STOP**.

---

## Searching Directly by Chapter or Track Number

---

Use this function to easily move to the beginning of the chapters or tracks on the disc.

**1** During playback or pre-stop, input the number of chapter or track you desire by using the number keys ("0" to "9").

**2** Press **ENT**.

Playback starts from the selected chapter or track.

- This function cannot be used on discs on which no chapter numbers are recorded.
- The beginning of a track number cannot be directly found on the Video CD equipped with PBC (playback control). Set VCD PLAY MODE to turn the PBC function off. Refer to "Setting the video CD Play Mode" (page 20).
- Depending on the number of digits input, playback may start automatically even if **ENT**, is not pressed in step 2.
- Press **CLR** to delete the last digit in the chapter/track number. Press and hold **CLR** for at least 2 seconds to clear "Chapter" and "Track" numbers.
- Press **RETURN** to cancel the chapter/track search mode and resume normal playback.

## Chapter/Track/Title Repeat Playback

Use this function to play the disc's titles, chapters or tracks repeatedly.

### During playback, press **REPEAT**.

The repeat mode switches each time the button is pressed.

#### DVD

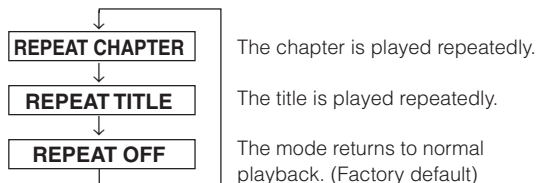

#### VIDEO CD

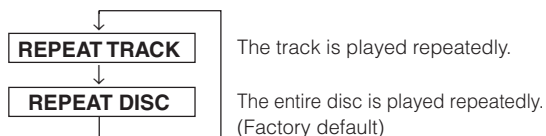

- The track/disc repeat modes cannot be used on video CDs with playback control (PBC). Set VCD PLAY MODE to turn the PBC function off. Refer to "Setting the video CD Play Mode" (page 20).
- For some discs it is not possible to switch the repeat mode.

## Switching the Audio Tracks

DVDs can have up to 8 different audio tracks. These alternate tracks can be switched during playback.

### During playback, press **AUDIO**.

The sound switches between the alternate audio tracks recorded on the disc each time the button is pressed.

- The selected alternate track becomes the default setting every time the power is turned on or the disc is replaced. If the disc does not include that track, the disc's default language is selected instead.
- Not all discs will allow changing the alternate audio tracks during playback. In these cases, select audio tracks from the DVDs menu.
- There may be a delay before the selected alternate track begins to play.

#### Video CDs with multiplex audio

### During playback, press **AUDIO**.

The left and right channels will be output as shown in the figure below, each time the button is pressed.

LR → LL → RR → LR

## Switching the Angle (DVD only)

On DVDs in which scenes have been filmed from multiple angles, the angle can be switched during playback.

### During playback, press **ANGLE**.

The angle switches between the angles recorded on the disc each time the button is pressed.

- Some time may be required for the angle to change.
- Depending on the disc, the angle may switch in one of two ways.
  - Seamless: The angle switches smoothly.
  - Non-seamless: When the angle is switched, a still picture is displayed first, after which the angle switches.

## Switching the Subtitles (subtitle language) (DVD only)

With multiple subtitle language DVDs, the subtitle language can be switched during playback, or subtitles can be hidden.

### During playback, press **SUBTITLE**.

The subtitle switches between the languages recorded on the disc and OFF each time the button is pressed.

- There may be a delay before the selected subtitle appears.
- Not all discs will allow changing the subtitles during playback. In these cases, select subtitles from the DVD's menu.
- The selected subtitle language becomes the default setting every time the power is turned on or the disc is replaced. If the disc does not include that language, the disc's default language is selected instead.
- For some discs, the subtitles will be displayed even when this is set to off.

#### Tips

##### Switching from the disc menu

For some discs, the audio language, angle and subtitles can be switched from the disc menu.

- 1 Press MENU, select the item, then press ENT.
- 2 Press ▲, ▼, ◀ or ▶ to select the language or angle, then press ENT.  
(For some discs, they can be selected using the number keys ("0" to "9") while the language or the angle menu is displayed.)

## Displaying the Disc Status (DVD only)

Use the procedure described below to display the status (title number, chapter number, etc.) of the currently playing DVD on the monitor screen.

### During playback, press **DISPLAY**.

The playback status is displayed.

The playback status display closes when pressed **DISPLAY** again.

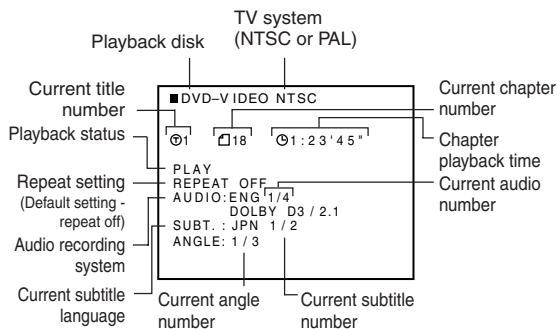

## Displaying the Disc Status (Video CD only)

Use the procedure described below to obtain an on-screen display of the status (track number, etc.) of the currently playing video CD on the monitor screen.

### During playback, press **DISPLAY**.

The playback status is displayed.

The playback status display closes when pressed **DISPLAY** again.

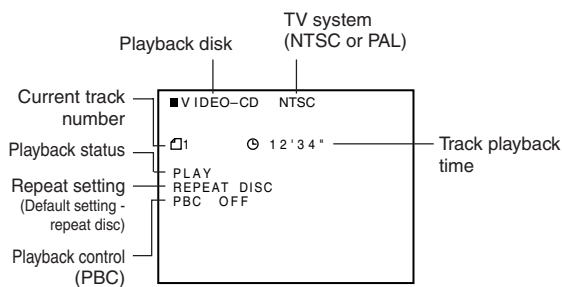

- When PBC is set to ON, the current track number and track playback time is not displayed.

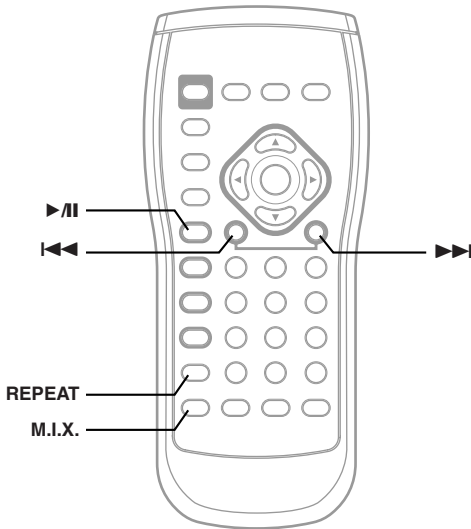

## Repeat Play

Press **REPEAT** to play back repeatedly the track being played.

The track will be played repeatedly.

Press **REPEAT** again and select OFF to deactivate repeat play.

## Playback

### 1 Insert a disc with the label side facing up.

To load discs, see "Loading and Unloading Discs" on page 9.

Playback starts.

### 2 During playback, press **◀◀** or **▶▶** to select the desired track.

**Returning to the beginning of the current track :**

Press **◀◀**.

Press **◀◀** repeatedly to start playback from the beginning of a previous track.

**Fast backward :**

Press and hold **◀◀**.

**Advancing to the beginning of the next track :**

Press **▶▶**.

**Fast forward :**

Press and hold **▶▶**.

### 3 To pause playback, press **▶||**.

Pressing **▶||** again will resume playback.

- CD playback information (track no., TEXT etc.) will be displayed on the monitor during playback.
- Three-inch (8cm) CD's can be used.

## M.I.X. (Random Play)

Press **M.I.X.** in the play or pause mode.

The tracks on the disc will be played back in random sequence.

To cancel M.I.X. play, press **M.I.X.** again.

# MP3

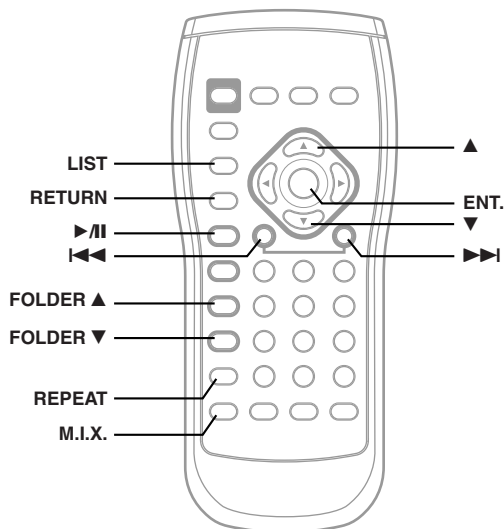

## Playback

The DVE-5207 will play back MP3 files stored on CD-ROMs, CD-Rs, and CD-RWs. The format used must be compliant with ISO9660 level 1 or level 2.

For further information about playing or storing MP3 files, refer to pages 16 before using the unit.

### 1 Insert a disc containing an MP3 file with the label side facing up.

To load discs, see "Loading and Unloading Discs" on page 9.

### 2 Press ◀◀ or ▶▶ to select the desired track.

#### Returning to the beginning of the current track :

Press ◀◀.

Press ◀◀ repeatedly to start playback from the beginning of a previous track.

#### Fast backward :

Press and hold ◀◀.

#### Advancing to the beginning of the next track :

Press ▶▶.

#### Fast forward :

Press and hold ▶▶.

### 3 To pause playback, press >/II.

Pressing >/II again will resume playback.

- MP3 playback information (folder no., file no., tag information, etc.) will be displayed on the monitor during playback.
- The CD-player can play discs containing audio data and MP3 data.
- For MP3 discs, some time may be required until playback starts.
- Some discs will not play back depending on the writing or MP3 conversion software used for the disc. In that case, try other software.
- During playback of a VBR (Variable Bit rates) file, the file or elapsed time may not be correctly displayed.

## Selecting Folders

Press **FOLDER ▲** or **FOLDER ▼** to select the folder.

- If **FOLDER ▲** is pressed during *M.I.X. DISC* playback, new files will be played back in a random sequence. If **FOLDER ▼** is pressed, the beginning of the current file will be played back.

## M.I.X. (Random Play)

Press **M.I.X.** in the play or pause mode.

The M.I.X. mode switches each time the button is pressed.

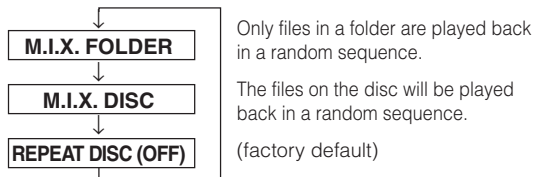

Press M.I.X. again and select REPEAT DISC (OFF) to deactivate the M.I.X. play.

## Repeat Play

During playback, press **REPEAT**.

The repeat mode switches each time the button is pressed.

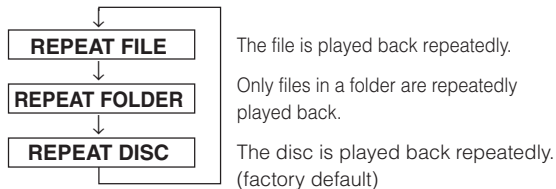

Press REPEAT again and select REPEAT DISC to deactivate the repeat play.

## Folder/File Name Search

You can display the names of folders/files and search for a folder/file to play.

### 1 Press LIST during playback.

The Folder Name list is displayed.

### 2 Press ▲ or ▼ to select a folder name, then press ENT.

The File Name list of the selected folder is displayed.

### 3 Press ▲ or ▼ to select a file name, then press ENT.

The selected file is played back.

- When there are 9 or more names on the list, a page number is displayed. Press ◀ or ▶ to change the page.
- Press RETURN to deactivate the Search mode during the Folder Name Search mode.
- While in File Name Search mode, press RETURN to switch to Folder Name Search mode.
- While in Folder Name Search/File Name Search mode, press LIST to cancel the Folder Name Search/File Name Search mode.



## About MP3

### CAUTION

Except for private use, duplicating audio data (including MP3 data) or distributing, transferring, or copying it, whether for free or for a fee, without permission of the copyright holder is strictly prohibited by the Copyright Act and by international treaty.

### What is MP3?

MP3 (MPEG-1 Audio Layer 3) is a compression standard prescribed by the ISO, the International Standardization Organization and MPEG, which is a joint activity institution of the IEC.

MP3 files contain compressed audio data. MP3 encoding is capable of compressing audio data at extremely high ratios, reducing the size of music files to as much as one-tenth their original size. This is achieved while still maintaining near CD quality. The MP3 format realizes such high compression ratios by eliminating the sounds that are either inaudible to the human ear or masked by other sounds.

### Method for creating MP3 files

Audio data is compressed by using MP3 specified software. For details on creating MP3 files, refer to the user's manual for that software.

MP3 files that can be played back by this device have the file extension "mp3." Files with no extension cannot be played back.

### Supported playback sampling rates and bit rates

#### MP3

Sampling rates: 32 kHz - 48 kHz

Bit rates: 32 - 320 kbps

Note that for sampling rates, this device may not display correctly.

This device may not playback correctly depending on sampling rates.

### ID3 tags

If tag data is in an MP3 file, this device can display the title (track title), artist name, and album name ID3 tag data.

This device can only display single-byte alphanumeric characters and the underscore.

However, the number of characters may be limited, or not correctly displayed, depending on the tag information.

### Producing MP3 discs

MP3 files are prepared, then written to a CD-R or CD-RW using CD-R writing software. A disc can hold a maximum of 1,024 files, and 256 folders (including the Root Folder). Downloading a disc may take a long time, depending on the configuration of folders or files. In this case, decreasing the number of folders or files is recommended.

### Media supported

The media that this device can play back are CD-ROMs, CD-Rs, and CD-RWs.

### Corresponding File Systems

This device supports discs formatted with ISO9660 Level 1 or Level 2.

Under the ISO9660 standard, there are some restrictions to remember.

The maximum nested folder depth is 8 (including the root directory). The number of characters for a folder/file name is limited.

Valid characters for folder/file names are letters A-Z (all caps), numbers 0-9, and '\_' (underscore).

This device also can play back discs in Joliet, etc., and other standards that conform to ISO9660. However, sometimes the file names, folder names, etc., are not displayed correctly.

### Formats supported

This device supports CD-ROM XA, Mixed Mode CD, Enhanced CD (CD-Extra) and Multi-Session.

This device cannot correctly play back discs recorded with Track At Once or packet writing.

### Order of files

The unit plays the files in the order that the writing software writes them. Therefore, the playing order may not be the same as the order you input. The playback order of the folders and files is as follows. However, the folder and file playback order differs from the folder no. and file no. indicated on the display.

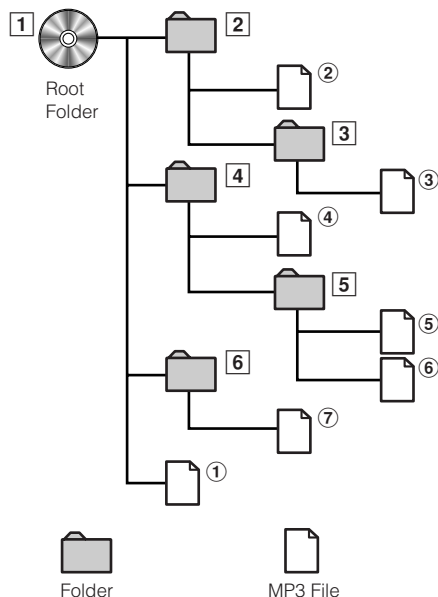

## Terminology

### Bit rate

This is the "sound" compression rate specified for encoding. The higher the bit rate, the higher the sound quality, but also the larger the files.

### Sampling rate

This value shows how many times per second the data is sampled (recorded). For example, music CDs use a sampling rate of 44.1 kHz, so the sound is sampled (recorded) 44,100 times per second. The higher the sampling rate, the higher the sound quality, but also the larger the volume of data.

### Encoding

Converting music CDs, WAVE (AIFF) files, and other sound files into the specified audio compression format.

### Tag

Song information such as track title, artist name, album name, etc., written into MP3 files.

MP3: ID3 tag

### Root folder

The root folder is found at the top of the file system. The root folder contains all folders and files.

# DVD Setup

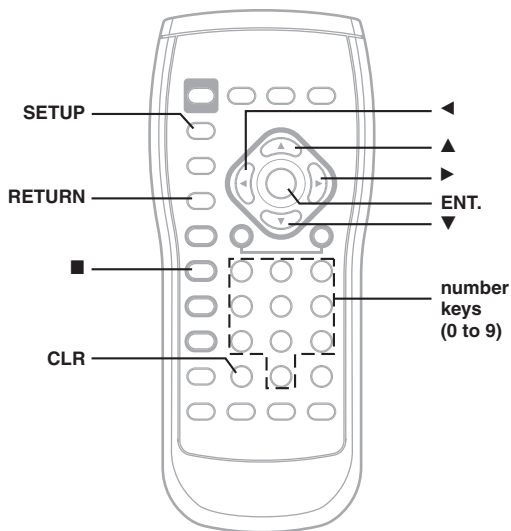

## Setting the language

The audio language, subtitle language and menu language can be set according to your preferences. Once set, this becomes the default language. This function is convenient when you always want to listen in English. (Not all discs allow changing the default language. If not, the factory default language applies.)

### Setting item: Language

Further setting items: AUDIO / SUBTITLE / MENU

**AUDIO:**  
Set the audio track language.

**SUBTITLE:**  
Set the language of the subtitles displayed on the screen.

**MENU:**  
Set the language used for the menus (title menu, etc.).

■ SETUP	
LANGUAGES	
AUDIO	AUTO
SUBTITLE	AUTO
MENU	AUTO

### Setting contents:

**AUTO**\*1 / **ENGLISH** / **JAPANESE** / **GERMAN** / **SPANISH** / **FRENCH** / **ITALIAN** / **PORTUGUESE** / **RUSSIAN** / **CHINESE** / **OTHERS**\*2

Press ▲, ▼, ◀ or ▶ to select the desired language, then press ENT.

- \*1 **AUTO:**  
The disc is played with the audio language or subtitle language set as the priority language for the disc.
- \*2 **OTHERS:**  
Set this to play the disc with a language other than one of the languages displayed. Press ENT. then use the **number keys** "0" to "9" to input the 4-digit language code. Then press ENT. again. For the language codes, refer to "List of Language Codes" (page 23).

- If you change the language setting when the disc is inside, the setting is decided with one of the following operations.  
- Disc eject  
- Turn OFF the main unit
- To temporarily change the language of the current disc, either do so from the DVD menu or using the operation described in the section "Switching the audio tracks" (page 12).
- If the disc does not include the selected language, the disc's default language is set.
- Languages set upon shipment from the factory:  
Audio language : AUTO  
Subtitle language : AUTO  
Menu language : AUTO
- Press **RETURN** to return to the previous display.

## DVD Setup Operation

The following steps 1 to 4 are common operations to each setting item of DVD settings. Refer to each section for details.

### 1 Press **SETUP** before inserting a disc, or when in stop mode.

The setup menu appears on the monitor.

■ SETUP	
LANGUAGES	
TV SCREEN	16:9 (WIDE)
COUNTRY CODE	DE-6869
PARENTAL	OFF
DIGITAL OUT	
CUSTOM SETUP	

### 2 Press ▲ or ▼ to select the desired setting item, then press **ENT.**

Further items will be displayed.

#### Setting items:

LANGUAGES / TV SCREEN / COUNTRY CODE / PARENTAL / DIGITAL OUT / CUSTOM SETUP\*1

\*1 Refer to "Custom Setup" on page 20.

### 3 Press ▲ or ▼ to change the setting item, then press **ENT.**

### 4 Press **SETUP.**

The settings are stored and the setup mode is deactivated.

- When settings are changed, old settings are overwritten. Make a note of the current settings before making changes. If the vehicle's battery is disconnected, the settings will be cleared and will return to the factory settings.

## Setting the TV Screen

Use the procedure described below to set the output screen according to the type of TV monitor being used.

### Setting item: TV SCREEN

Setting contents: 16:9 (WIDE) / 4:3 (LB) / 4:3 (PS)

- For some discs, the picture may not be set to the selected screen size. (For details, refer to the explanation on the disc's jacket.)
- Press **RETURN** to return to the previous screen.

**Continued**

### 16 : 9 WIDE

Select this when connected to a wide screen TV. This is selected upon shipment from the factory.

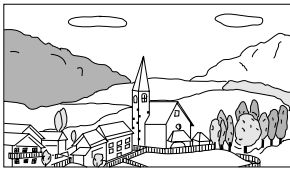

### 4 : 3 LB (LETTER BOX)

Select this when connected to a conventional 4 : 3 size (normal TV aspect ratio) monitor. There may be black bands visible at the top and bottom of the screen (when playing a 16 : 9 size movie). The width of these stripes will depend upon the original aspect ratio of the theatre release of the movie.



### 4 : 3 PS (PAN-SCAN)

Select this when connected to a conventional 4 : 3 size monitor. The picture will fill the entire TV screen. However, due to the mismatch in aspect ratio, parts of the movie at the extreme left and right sides will not be visible (when playing a 16 : 9 size movie).

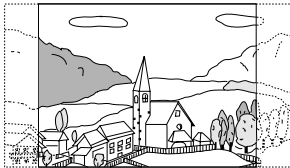

## Setting the Country Code

Set the country number of which you want to set the rating level (Parental lock).

### Setting item: COUNTRY CODE

#### Setting contents: CODE

- 1 Press ▲ or ▼ to select "COUNTRY CODE," then press ENT.

"COUNTRY CODE" will be reset.

#### COUNTRY CODE - - - -

- 2 Use the number keys "0" to "9" to input the 4-digit country code, then press ENT.  
Example: Germany "6869" is input

#### COUNTRY CODE 6 8 6 9

- If the input code is wrong, the unit returns to the country code input display, after displaying "CODE ERROR" for 5 seconds.
- For the country codes, refer to "List of Country Codes" (Pages 24 and 25).
- Can be erased one digit at a time each time CLR is pressed. Press CLR for at least 2 seconds to delete all digits.
- Press RETURN to return to the previous screen.

## Setting the Rating Level (Parental Lock)

Use this function to restrict the viewing of movies to children of appropriate age levels only.

### Setting item: PARENTAL

#### Setting contents: PASSWORD

- 1 Press ▲ or ▼ to select "PARENTAL," then press ENT.  
The password input mode is activated.

- 2 Use the number keys "0" to "9" to input the 4-digit password, then press ENT.

#### PASSWORD \* \* \* \*

Input numbers are displayed as "\*."

The default password is 1111 upon shipment from the factory.

The restriction level (PARENTAL LEVEL) input display appears.

- Can be erased one digit at a time each time CLR is pressed. Press CLR for at least 2 seconds to delete all digits.
- Press RETURN to return to the previous screen.
- If the password is wrong, the unit returns to the password input display, after displaying "PASSWORD ERROR" for 5 seconds.

- 3 Press ▲, ▼, ◀ or ▶ to select the rating level (1 to 8), then press ENT.

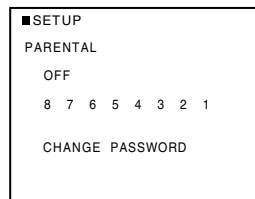

Select "OFF" to cancel the parental lock or if you do not want to set a rating level.

The lower the number, the higher the rating level.

- Press RETURN to return to the previous display.
- 4 Press SETUP.  
The settings are stored and the setup mode is deactivated.
- If you want to change the password, select "CHANGE PASSWORD," then input the new password (4 digits).
- Write down the password on a piece of paper and store the piece of paper somewhere in case you forget it.
- On unrated DVDs, playback will not be restricted even if the rating level is set.
- Once set, this rating level remains in memory until changed. To enable the play of discs of higher rating levels or to cancel the parental lock, the setting must be changed.
- Not all DVDs provide a Parental Lock feature. If you are unsure about a DVD, play it first to confirm. Do not leave DVDs accessible to young children for whom you deem them inappropriate.

### Tips

- **Changing the rating level temporarily**  
Some discs may request that you change the rating level set in the default settings during playback. In this case, the message appears on the monitor screen "PARENTAL LEVEL CHANGE OK?"
- **To change parental level and play, press ENT.**  
The password input mode is displayed. Input the 4-digit password in "Setting the Rating Level (Parental Lock)" you set, then press ENT.
- **To play without changing the parental level, press ■.**  
(When ■ is pressed, playback will be at the parental level set with "Setting the Rating Level (Parental Lock).")

## Setting the Digital Output

Use the following procedure to set the digital audio signal output from the DVE-5207.

### Setting item: DIGITAL OUT

#### Further setting items: DOLBY D / DTS / MPEG

Press ▲ or ▼ to select your desired setting item, then press ENT.

**DOLBY D:** Sets Dolby Digital output.  
The initial setting is BITSTREAM.

**DTS:** Sets DTS output.  
The initial setting is BITSTREAM.

**MPEG:** Sets MPEG audio output by converting 48 kHz/16 bit linear PCM (DVD) or 44.1 kHz (Video CD, CD).  
The initial setting is LPCM.

#### Setting contents: BITSTREAM / LPCM

Press ▲ or ▼ to select BITSTREAM or LPCM, then press ENT.

**BITSTREAM:** The digital output is switched automatically according to the type of audio signal being played.  
Be sure to select "BITSTREAM" when you want to connect a digital audio processor and play Dolby Digital audio.

**LPCM:** The audio signal recorded on the disc is converted to 48 kHz/16 bit (for DVDs) or 44.1 kHz (for video CDs and CDs) linear PCM audio signals for output.

- Press **RETURN** to return to the previous screen.

## Audio output/Optical digital audio output

Disc	Audio recording format	Digital output setting	Optical digital audio output (when a digital audio processor is connected)	Analog audio output (RCA output)	
DVD	DTS	AUTO	DTS Elementary Stream	OK	
		LPCM	LPCM Encode 2ch Down mix (44.1kHz or 48kHz/16bit)	OK	
	Dolby Digital	AUTO	Dolby Digital	OK	
		LPCM	LPCM (48kHz/16bit)	OK	
	Linear PCM	48kHz/16bit	AUTO or LPCM	LPCM (48kHz/16bit)	OK
		48kHz/20bit	AUTO or LPCM	LPCM (48kHz/16bit)	OK
		48kHz/24bit	AUTO or LPCM	LPCM (48kHz/16bit)	OK
		96kHz/16bit	AUTO or LPCM	LPCM (48kHz/16bit)	OK
		96kHz/20bit	AUTO or LPCM	LPCM (48kHz/16bit)	OK
		96kHz/24bit	AUTO or LPCM	LPCM (48kHz/16bit)	OK
MPEG2	AUTO or LPCM	LPCM (44.1kHz or 48kHz/16bit)	OK		
Video CD	MPEG1	AUTO or LPCM	LPCM (44.1kHz)	OK	
CD	Linear PCM	AUTO or LPCM	LPCM (44.1kHz)	OK	
		DTS	AUTO	DTS Elementary Stream	OK
		LPCM	LPCM Encode 2ch Down mix (44.1kHz/16bit)	OK	
MP3	MPEG-1 Audio Layer3 Bit Rate: 32kbps-320kbps	32kHz/16bit	AUTO or LPCM	LPCM Encode 2ch (32kHz/16bit)	OK
		44.1kHz/16bit	AUTO or LPCM	LPCM Encode 2ch (44.1kHz/16bit)	OK
		48kHz/16bit	AUTO or LPCM	LPCM Encode 2ch (48kHz/16bit)	OK

# Custom Setup

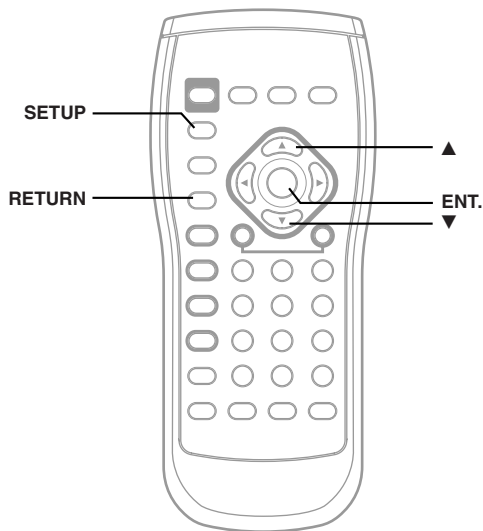

## Custom Setup Operation

The following steps (1 through 5) are common to each of the mode settings. Once the mode is selected under the CUSTOM SETUP menu, refer to the section for that mode for details.

### 1 Press **SETUP** before inserting a disc, or when in stop mode.

The setup menu appears on the monitor.

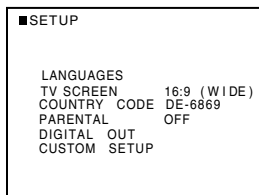

### 2 Press **▲** or **▼** to select "CUSTOM SETUP," then press **ENT.**

### 3 Press **▲** or **▼** to select your desired setting item, then press **ENT.**

#### **CUSTOM SETUP items:**

CD PLAY MODE / VCD PLAY MODE / PAUSE MODE / DOWNMIX MODE

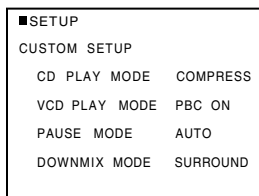

### 4 Press **▲** or **▼** to change the setting item, then press **ENT.**

### 5 Press **SETUP**.

The settings are stored and the setup mode is deactivated.

- Press **RETURN** to return to the previous display.
- When settings are changed, old settings are overwritten. Make a note of the current settings before making changes. If the vehicle's battery is disconnected, the settings will be cleared and will return to the factory settings.

#### Setting the CD Play Mode

The unit can be set to play only the audio data or only the MP3 files on discs containing both types of music data.

##### **Setting item: CD PLAY MODE**

**Setting contents: CD-DA / COMPRESSED AUDIO**

**CD-DA:** Only CD data can be played back. The initial setting at the factory is CD-DA.

**COMPRESSED AUDIO:** Only MP3 data can be played back.

- If a disc has already been inserted, perform the setting after you remove the disc.

#### Setting the Video CD Play Mode

When playing a Playback Control (PBC) enabled video CD, you can choose to set PBC ON or OFF.

##### **Setting item: VCD PLAY MODE**

**Setting contents: PBC ON / PBC OFF**

**PBC ON:** The PBC menu is displayed.

**PBC OFF:** The PBC menu is not displayed.

The initial setting at the factory is PBC ON.

#### Setting the Pause Mode

In pause mode, screen blurring may occur. To overcome this, set AUTO/FIELD/FRAME accordingly.

##### **Setting item: PAUSE MODE**

**Setting contents: AUTO / FIELD / FRAME**

If you experience blurring during pause mode, set to FIELD or FRAME.

The initial setting at the factory is AUTO.

#### Setting the Downmix Mode

This function applies to Dolby Digital, DTS stream sound.

##### **Setting item: DOWNMIX MODE**

**Setting contents: STEREO / SURROUND ENCODED**

**STEREO:** Stereo Downmix

**SURROUND ENCODED:** Surround compatible Downmix

The initial setting at the factory is SURROUND ENCODED.

# Information

## About DVDs

Music CDs and DVDs have grooves (tracks) in which the digital data is recorded. The data is represented as microscopic pits recorded into the track – these pits are read by a laser beam to play the disc. On DVDs, the density of the tracks and pits is twice that of CDs, so DVDs can contain more data in less space.

### CDs

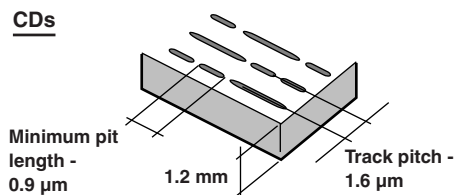

### DVDs

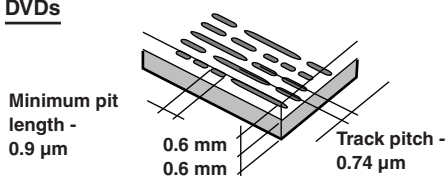

A 12 cm disc can contain one movie or about four hours of music. In addition, DVDs provide sharp picture quality with vivid colours thanks to a horizontal resolution of over 500 lines (compared to less than 300 for VHS tape). With the addition of an optional, digital audio processor (PXA-H510, PXA-H900, PXA-H701, etc.), you can recreate the power and presence of a movie theater with Dolby Digital 5.1-channel Surround.

## In addition, DVDs offer a variety of functions.

- **Multiple audio\*** (page 12)  
Movies can be recorded in up to eight languages. The desired language can be selected from the remote control.
  - **Multi angle function\*** (page 12)  
When the DVD contains a movie shot from multiple angles, the desired angle can be selected from the remote control.
  - **Subtitles function\*** (page 12)  
Movies can include subtitles in up to 32 languages. The desired subtitle language can be selected from the remote control.
  - **Multi story function\***  
With this function, a single movie includes various story lines. You can select different story lines to view various versions of the same movie. Operation differs from disc to disc. Story line selection screens including instructions appear during the movie. Just follow the instructions.
- \* *The functions, audio languages, subtitle languages, angles, etc., differ from disc to disc. For details, refer to the disc's instructions.*

## Terminology

### Dolby Digital

Dolby Digital is a digital audio compression technology developed by Dolby Laboratories that allows large quantities of audio data to be efficiently recorded on discs. It is compatible with audio signals from mono (1 channel) all the way up to 5.1-channel surround sound. The signals for the different channels are completely independent, and since the sound is high quality digital there is no loss of sound quality.

\* *The separately sold digital audio processor (PXA-H510, PXA-H900, PXA-H701, etc.) is required to enjoy full 5.1-channel surround sound.*

The DVE-5207 performs Dolby Digital decoding when it outputs analog audio signals; 2-channel audio, not 5.1-channel.

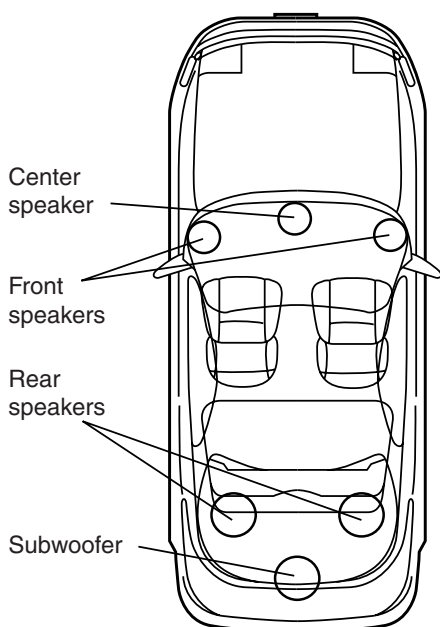

**Speaker layout for enjoying Dolby Digital sound/dts sound**

### DTS

This is a home-use digital sound format of the DTS Sound System. This is a high quality sound system, developed by Digital Theater Systems, Inc. for use in movie theaters. DTS has six independent sound tracks. The theater presentation is fully realized in the home, etc. DTS is the abbreviation for Digital Theater System.

\* *To enjoy DTS surround sound you need the separately sold DTS digital audio processor (PXA-H900, PXA-H701, etc.). The DVD video software must also have a DTS sound track.*

The DVE-5207 has a built-in DTS 2-channel audio decoder. Analog audio outputs are available.

### Dolby Pro Logic

Dolby Pro Logic is the technology used to decode programs encoded in Dolby Surround. Pro Logic decoding will provide you with four channels of sound (front left/right, centre and monaural rear surround) from a 2-channel (stereo) source.

\* *The separately sold digital audio processor (PXA-H510, PXA-H900) is required to enjoy Dolby Pro Logic surround sound.*

### Dolby Pro Logic II

Dolby Pro Logic II plays 2-channel sources in 5 channels over the entire frequency range.

This is done with an advanced, high sound quality matrix surround decoder which draws out the spatial properties of the original recording without adding any sounds to or changing the sound of the source.

\* *The separately sold digital audio processor (PXA-H701, etc.) is required to enjoy Dolby Pro Logic II surround sound.*

### Linear PCM audio (LPCM)

LPCM is a signal recording format used for music CDs. Whereas music CDs are recorded at 44.1 kHz/16 bits, DVDs are recorded at 48 kHz/16 bits to 96 kHz/24 bits, thereby achieving higher sound quality than music CDs.

### Rating levels (parental lock)

This is a DVD function for restricting the viewing age as stipulated by censorship laws in different countries. The way in which viewing is restricted differs from DVD to DVD. Sometimes the DVD cannot be played at all, other times certain scenes are skipped, and other times certain scenes are replaced with other scenes.

## List of Language Codes

(For details, see page 17.)

Abbreviation	Code	Language	Abbreviation	Code	Language	Abbreviation	Code	Language
AA	6565	Afar	IE	7369	Interlingue	RN	8278	Kirundi
AB	6566	Abkhazian	IK	7375	Inupiak	RO	8279	Romanian
AF	6570	Afrikaans	IN	7378	Indonesian	RU	8285	Russian
AM	6577	Amharic	IS	7383	Icelandic	RW	8287	Kinyarwanda
AR	6582	Arabic	IT	7384	Italian	SA	8365	Sanskrit
AS	6583	Assamese	IW	7387	Hebrew	SD	8368	Sindhi
AY	6589	Aymara	JA	7465	Japanese	SG	8371	Sangho
AZ	6590	Azerbaijani	JI	7473	Yiddish	SH	8372	Serbo-Croatian
BA	6665	Bashkir	JW	7487	Javanese	SI	8373	Singhalese
BE	6669	Byelorussian	KA	7565	Georgian	SK	8375	Slovak
BG	6671	Bulgarian	KK	7575	Kazakh	SL	8376	Slovenian
BH	6672	Bihari	KL	7576	Greenlandic	SM	8377	Samoan
BI	6673	Bislama	KM	7577	Cambodian	SN	8378	Shona
BN	6678	Bengali, Bangla	KN	7578	Kannada	SO	8379	Somali
BO	6679	Tibetan	KO	7579	Korean	SQ	8381	Albanian
BR	6682	Breton	KS	7583	Kashmiri	SR	8382	Serbian
CA	6765	Catalan	KU	7585	Kurdish	SS	8383	Siswati
CO	6779	Corsican	KY	7589	Kirghiz	ST	8384	Sesotho
CS	6783	Czech	LA	7665	Latin	SU	8385	Sundanese
CY	6789	Welsh	LN	7678	Lingala	SV	8386	Swedish
DA	6865	Danish	LO	7679	Laothian	SW	8387	Swahili
DE	6869	German	LT	7684	Lithuanian	TA	8465	Tamil
DZ	6890	Bhutani	LV	7686	Latvian, Lettish	TE	8469	Telugu
EL	6976	Greek	MG	7771	Malagasy	TG	8471	Tajik
EN	6978	English	MI	7773	Maori	TH	8472	Thai
EO	6979	Esperanto	MK	7775	Macedonian	TI	8473	Tigrinya
ES	6983	Spanish	ML	7776	Malayalam	TK	8475	Turkmen
ET	6984	Estonian	MN	7778	Mongolian	TL	8476	Tagalog
EU	6985	Basque	MO	7779	Moldavian	TN	8478	Setswana
FA	7065	Persian	MR	7782	Marathi	TO	8479	Tonga
FI	7073	Finnish	MS	7783	Malay	TR	8482	Turkish
FJ	7074	Fiji	MT	7784	Maltese	TS	8483	Tsonga
FO	7079	Faroese	MY	7789	Burmese	TT	8484	Tatar
FR	7082	French	NA	7865	Nauru	TW	8487	Twi
FY	7089	Frisian	NE	7869	Nepali	UK	8575	Ukrainian
GA	7165	Irish	NL	7876	Dutch	UR	8582	Urdu
GD	7168	Scots Gaelic	NO	7879	Norwegian	UZ	8590	Uzbek
GL	7176	Galician	OC	7967	Occitan	VI	8673	Vietnamese
GN	7178	Guarani	OM	7977	(Afan) Oromo	VO	8679	Volapuk
GU	7185	Gujarati	OR	7982	Oriya	WO	8779	Wolof
HA	7265	Hausa	PA	8065	Punjabi	XH	8872	Xhosa
HI	7273	Hindi	PL	8076	Polish	YO	8979	Yoruba
HR	7282	Croatian	PS	8083	Pashto, Pushto	ZH	9072	Chinese
HU	7285	Hungarian	PT	8084	Portuguese	ZU	9085	Zulu
HY	7289	Armenian	QU	8185	Quechua			
IA	7365	Interlingua	RM	8277	Rhaeto-Romance			



## List of Country Codes

(For details, see page 18.)

Abbreviation	Code	Country	Abbreviation	Code	Country	Abbreviation	Code	Country
AD	6568	Andorra	DM	6877	Dominica	KI	7573	Kiribati
AE	6569	United Arab Emirates	DO	6879	Dominican Republic	KM	7577	Comoros
AF	6570	Afghanistan	DZ	6890	Algeria	KN	7578	Saint Kitts and Nevis
AG	6571	Antigua and Barbuda	EC	6967	Ecuador	KP	7580	Korea, Democratic People's Republic of
AI	6573	Anguilla	EE	6969	Estonia			
AL	6576	Albania	EG	6971	Egypt	KR	7582	Korea, Republic of
AM	6577	Armenia	EH	6972	Western Sahara	KW	7587	Kuwait
AN	6578	Netherlands Antilles	ER	6982	Eritrea	KY	7589	Cayman Islands
AO	6579	Angola	ES	6983	Spain	KZ	7590	Kazakistan
AQ	6581	Antarctica	ET	6984	Ethiopia	LA	7665	Lao People's Democratic Republic
AR	6582	Argentina	FI	7073	Finland			
AS	6583	American Samoa	FJ	7074	Fiji	LB	7666	Lebanon
AT	6584	Austria	FK	7075	Falkland Islands	LC	7667	Saint Lucia
AU	6585	Australia	FM	7077	Micronesia, Federated States of	LI	7673	Liechtenstein
AW	6587	Aruba	FO	7079	Faroe Islands	LK	7675	Sri Lanka
AZ	6590	Azerbaijan	FR	7082	France	LR	7682	Liberia
BA	6665	Bosnia and Herzegovina	GA	7165	Gabon	LS	7683	Lesotho
BB	6666	Barbados	GB	7166	United Kingdom	LT	7684	Lithuania
BD	6668	Bangladesh	GD	7168	Grenada	LU	7685	Luxembourg
BE	6669	Belgium	GE	7169	Georgia	LV	7686	Latvia
BF	6670	Burkina Faso	GF	7170	French Guiana	LY	7689	Libyan Arab Jamahiriya
BG	6671	Bulgaria	GH	7172	Ghana	MA	7765	Morocco
BH	6672	Bahrain	GI	7173	Gibraltar	MC	7767	Monaco
BI	6673	Burundi	GL	7176	Greenland	MD	7768	Moldova, Republic of
BJ	6674	Benin	GM	7177	Gambia	MG	7771	Madagascar
BM	6677	Bermuda	GN	7178	Guinea	MH	7772	Marshall Islands
BN	6678	Brunei Darussalam	GP	7180	Guadeloupe	MK	7775	Macedonia, The former Yugoslav Republic of
BO	6679	Bolivia	GQ	7181	Equatorial Guinea			
BR	6682	Brazil	GR	7182	Greece	ML	7776	Mali
BS	6683	Bahamas	GS	7183	South Georgia and the South Sandwich Islands	MM	7777	Myanmar
BT	6684	Bhutan				MN	7778	Mongolia
BV	6686	Bouvet Island	GT	7184	Guatemala	MO	7779	Macau
BW	6687	Botswana	GU	7185	Guam	MP	7780	Northern Mariana Islands
BY	6689	Belarus	GW	7187	Guinea-Bissau	MQ	7781	Martinique
BZ	6690	Belize	GY	7189	Guyana	MR	7782	Mauritania
CA	6765	Canada	HK	7275	Hong Kong	MS	7783	Montserrat
CC	6767	Cocos (Keeling) Islands	HM	7277	Heard Island and McDonald Islands	MT	7784	Malta
CD	6768	Congo, the Democratic Republic of the	HN	7278	Honduras	MU	7785	Mauritius
CF	6770	Central African Republic	HR	7282	Croatia	MV	7786	Maldives
CG	6771	Congo	HT	7284	Haiti	MW	7787	Malawi
CH	6772	Switzerland	HU	7285	Hungary	MX	7788	Mexico
CI	6773	Cote d'Ivoire	ID	7368	Indonesia	MY	7789	Malaysia
CK	6775	Cook Islands	IE	7369	Ireland	MZ	7790	Mozambique
CL	6776	Chile	IL	7376	Israel	NA	7865	Namibia
CM	6777	Cameroon	IN	7378	India	NC	7867	New Caledonia
CN	6778	China	IO	7379	British Indian Ocean Territory	NE	7869	Niger
CO	6779	Colombia	IQ	7381	Iraq	NF	7870	Norfolk Island
CR	6782	Costa Rica	IR	7382	Iran, Islamic Republic of	NG	7871	Nigeria
CU	6785	Cuba	IS	7383	Iceland	NI	7873	Nicaragua
CV	6786	Cape Verde	IT	7384	Italy	NL	7876	Netherlands
CX	6788	Christmas Island	JM	7477	Jamaica	NO	7879	Norway
CY	6789	Cyprus	JO	7479	Jordan	NP	7880	Nepal
CZ	6790	Czech Republic	JP	7480	Japan	NR	7882	Nauru
DE	6869	Germany	KE	7569	Kenya	NU	7885	Niue
DJ	6874	Djibouti	KG	7571	Kyrgyzstan	NZ	7890	New Zealand
DK	6875	Denmark	KH	7572	Cambodia	OM	7977	Oman
						PA	8065	Panama

Abbreviation	Code	Country	Abbreviation	Code	Country	Abbreviation	Code	Country
PE	8069	Peru	SJ	8374	Svalbard and Jan Mayen	TW	8487	Taiwan, Province of China
PF	8070	French Polynesia	SK	8375	Slovakia	TZ	8490	Tanzania, United Republic of
PG	8071	Papua New Guinea	SL	8376	Sierra Leone	UA	8565	Ukraine
PH	8072	Philippines	SM	8377	San Marino	UG	8571	Uganda
PK	8075	Pakistan	SN	8378	Senegal	UM	8577	United States Minor Outlying Islands
PL	8076	Poland	SO	8379	Somalia	US	8583	United States
PM	8077	Saint Pierre and Miquelon	SR	8382	Suriname	UY	8589	Uruguay
PN	8078	Pitcairn	ST	8384	Sao Tome and Principe	UZ	8590	Uzbekistan
PR	8082	Puerto Rico	SV	8386	El Salvador	VA	8665	Holy See (Vatican City State)
PT	8084	Portugal	SY	8389	Syrian Arab Republic	VC	8667	Saint Vincent and the Grenadines
PW	8087	Palau	SZ	8390	Swaziland	VE	8669	Venezuela
PY	8089	Paraguay	TC	8467	Turks and Caicos Islands	VG	8671	Virgin Island, British
QA	8165	Qatar	TD	8468	Chad	VI	8673	Virgin Islands, U.S
RE	8269	Reunion	TF	8470	French Southern Territories	VN	8678	Viet Nam
RO	8279	Romania	TG	8471	Togo	VU	8685	Vanuatu
RU	8285	Russian Federation	TH	8472	Thailand	WF	8770	Wallis and Futuna
RW	8287	Rwanda	TJ	8474	Tajikistan	WS	8783	Samoa
SA	8365	Saudi Arabia	TK	8475	Tokelau	YE	8969	Yemen
SB	8366	Solomon Islands	TM	8477	Turkmenistan	YT	8984	Mayotte
SC	8367	Seychelles	TN	8478	Tunisia	YU	8985	Yugoslavia
SD	8368	Sudan	TO	8479	Tonga	ZA	9065	South Africa
SE	8369	Sweden	TP	8480	East Timor	ZM	9077	Zambia
SG	8371	Singapore	TR	8482	Turkey	ZW	9087	Zimbabwe
SH	8372	Saint Helena	TT	8484	Trinidad and Tobago			
SI	8373	Slovenia	TV	8486	Tuvalu			

## In Case of Difficulty

If you encounter a problem, please turn the power off, then on again. If the unit is still not functioning normally, please review the items in the following checklist. This guide will help you isolate the problem if the unit is at fault. Otherwise, make sure the rest of your system is properly connected or consult your authorized Alpine dealer.

### No function or display.

- Vehicle's ignition is off.
  - If connected following the instructions, the unit will not operate with the vehicle's ignition off.
- Improper power lead connections.
  - Check power lead connections.
- Blown fuse.
  - Replace the fuse on the battery lead of the unit with the proper value.

### Disc playback sound is wavering.

- Moisture condensation in the disc unit.
  - Allow enough time for the condensation to evaporate (about 1 hour).

### Disc insertion not possible.

- A disc is already in the DVD player.
  - Eject the disc and remove it.
- The disc is being improperly inserted.
  - Re-insert the disc following the instructions in the "Loading and Unloading Discs" section.

### Unable to fast forward or reverse the disc.

- The disc has been damaged.
  - Eject the disc and discard it; using a damaged disc in your unit can cause damage to the mechanism.

### Disc playback sound skips due to vibration.

- Improper mounting of the unit.
  - Securely re-mount the unit.
- The disc is very dirty.
  - Clean the disc.
- The disc has scratches.
  - Change the disc.
- The pick-up lens is dirty.
  - Do not use a commercial available lens cleaner disc. Consult your nearest ALPINE dealer.

### Disc playback sound skips without vibration.

- Dirty or scratched disc.
  - Clean the disc; damaged disc should be replaced.

### CD-R/CD-RW playback not possible.

- Close session (finalization) has not been performed.
  - Perform finalization and attempt playback again.

### Error displays

- Mechanical error
  - Press **▲**. After the error indication disappears, insert the disc again. If the above-mentioned solution does not solve the problem, consult your nearest ALPINE dealer.

### MP3 is not played back.

- Writing error occurred. The CD format is not compatible.
  - Make sure the CD has been written in a supported format. Refer to "About MP3" on pages 16, then rewrite in the format supported by this device.

### Unit does not operate.

- Monitor's power is not turned on.
  - Turn on the monitor's power.
- Condensation
  - Wait a while (about 1 hour) for the condensation to dry.

### No picture is produced.

- Monitor's mode is not switched to the mode you want to see.
  - Switch to the mode you want to see.
- Monitor's parking brake cord is not connected.
  - Connect the monitor's parking brake cord and set the parking brake. (For details, refer to the monitor's instructions.)
- Monitor's parking brake is not set.
  - Connect the monitor's parking brake cord and set the parking brake. (For details, refer to the monitor's instructions.)

### Playback does not start.

- Disc is loaded upside-down.
  - Check the disc and load it with the labeled side facing upward.
- The disc is dirty.
  - Clean the disc.
- A disc not able to playback with this unit is loaded.
  - Check if the disc is able to be played back.
- Parental lock is set.
  - Cancel the parental lock or change the rating level.
- Setup menu is displayed.
  - Press **SETUP** to turn the menu off.

### Picture is unclear or noisy.

- Disc is being fast-forwarded or fast-reversed.
  - The picture may be unclear, but this is normal.
- Vehicle's battery power is weak.
  - Check the battery power and wiring. (The unit may malfunction if the battery power is under 11 volts with a load applied.)
- Monitor's fluorescent tube is worn out.
  - Replace the monitor's fluorescent tube.

### Image stops sometimes.

- Disc is scratched.
  - Replace with a non-scratched disc.

## Indication

### DISC ERROR

- Mechanism error.
  - 1) Press **▲** and eject the disc.
    - If the disc does not eject, press **▲** again for at least 3 seconds and eject the disc.
    - If the disc still does not eject, consult your Alpine dealer.
  - 2) When the error indication remains after ejecting, press **▲** again.
    - If the error indication still does not turn off after pressing **▲** a few times, consult your Alpine dealer.
- The temperature in the car is too low.
  - Raise the temperature in the car to normal temperature.

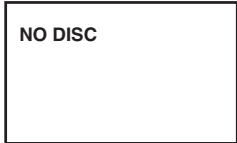

- No disc is inserted.
  - Insert a disc.
- Although a disc is inserted, "NO DISC" is displayed and the unit does not start to play or eject the disc.
  - Remove the disc by pressing **▲** again for at least 3 seconds.

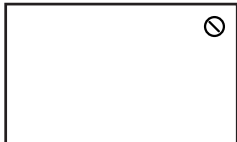

- Remote control operation is not possible.
  - For some discs or playing modes, certain operations are not possible. This is not a malfunction.

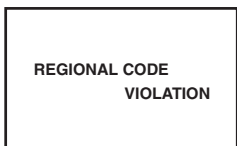

- Disc does not match regional code number.
  - Load a disc that matches the regional code number.



- Protective circuit is activated at high temperature.
  - The indicator will disappear when the temperature returns to within operation range.
  - Leave the power OFF until the temperature decreases and then turn the power ON again.



- Mechanism error.
  - 1) Press **▲** and eject the disc.
    - If the disc does not eject, press **▲** again for at least 3 seconds and eject the disc.
    - If the disc still does not eject, consult your Alpine dealer.
  - 2) When the error indication remains after ejecting, press **▲** again.
    - If the error indication still does not turn off after pressing **▲** a few times, consult your Alpine dealer.

## Specifications

### Frequency Response

DVD: 5 – 22,000 Hz (± 1 dB) (48 kHz sampling)  
 5 – 44,000 Hz (± 1 dB) (96 kHz sampling)  
 CD: 5 – 20,000 Hz (± 1 dB)

Wow & Flutter (% WRMS)	Below measurable limits
Total Harmonic Distortion	0.008 % (at 1 kHz)
Dynamic Range	95 dB (at 1 kHz)
Channel Separation	85 dB (at 1 kHz)
Signal system	NTSC/PAL
Horizontal resolution	500 lines or greater
Video output level	1 Vp-p (75 ohms)
Video S/N ratio	DVD: 60 dB
Audio S/N ratio	DVD: 95 dB
	CD: 105 dB

### PICKUP

Wave length	DVD: 665 nm
	CD: 800 nm
Laser power	CLASS II

### REMOTE CONTROL

Battery Type	CR2025 battery
Width	51 mm (2")
Height	119 mm (4-11/16")
Depth	13 mm (33/64")
Weight	50 g (1.75 oz) (battery excluded)

### GENERAL

Power Requirement	14.4 V DC (11–16 V allowable)
Operating Temperature	+14°F to +140°F (-10°C to + 60°C)
Audio Output Level	
Auxout:	1.2V/10k ohms

### CHASSIS SIZE

Width	178 mm (7")
Height	50 mm (2")
Depth	165 mm (6-1/2")
Weight	1.5kg (3 lbs. 5 oz)

- Due to continuous product improvement, specifications and design are subject to change without notice.

### CAUTION



(Bottom side of player)

CAUTION-Laser radiation when open, DO NOT STARE INTO BEAM

(Bottom side of player)

---

---

# Installation and Connections

Before installing or connecting the unit, please read the following and pages 3 and 4 of this manual thoroughly for proper use.

## Warning

---

---

### MAKE THE CORRECT CONNECTIONS.

Failure to make the proper connections may result in fire or product damage.

---

---

### USE ONLY IN CARS WITH A 12 VOLT NEGATIVE GROUND.

(Check with your dealer if you are not sure.) Failure to do so may result in fire, etc.

---

---

### BEFORE WIRING, DISCONNECT THE CABLE FROM THE NEGATIVE BATTERY TERMINAL.

Failure to do so may result in electric shock or injury due to electrical shorts.

---

---

### DO NOT ALLOW CABLES TO BECOME ENTANGLED IN SURROUNDING OBJECTS.

Arrange wiring and cables in compliance with the manual to prevent obstructions when driving. Cables or wiring that obstruct or hang up on places such as the steering wheel, gear lever, brake pedals, etc., can be extremely hazardous.

---

---

### DO NOT SPLICE INTO ELECTRICAL CABLES.

Never cut away cable insulation to supply power to other equipment. Doing so will exceed the current carrying capacity of the wire and result in fire or electric shock.

---

---

### DO NOT DAMAGE PIPE OR WIRING WHEN DRILLING HOLES.

When drilling holes in the chassis for installation, take precautions so as not to contact, damage or obstruct pipes, fuel lines, tanks or electrical wiring. Failure to take such precautions may result in fire.

---

---

### DO NOT USE BOLTS OR NUTS IN THE BRAKE OR STEERING SYSTEMS TO MAKE GROUND CONNECTIONS.

Bolts or nuts used for the brake or steering systems (or any other safety-related system), or tanks should NEVER be used for installations or ground connections. Using such parts could disable control of the vehicle and cause fire, etc.

---

---

### KEEP SMALL OBJECTS SUCH AS BATTERIES OUT OF THE REACH OF CHILDREN.

Swallowing them may result in serious injury. If swallowed, consult a physician immediately.

---

---

### DO NOT INSTALL IN LOCATIONS WHICH MIGHT HINDER VEHICLE OPERATION, SUCH AS THE STEERING WHEEL OR SHIFT LEVER.

Doing so may obstruct forward vision or hamper movement, etc., and result in a serious accident.

---

---

## Caution

---

---

### HAVE THE WIRING AND INSTALLATION DONE BY EXPERTS.

The wiring and installation of this unit requires special technical skill and experience. To ensure safety, always contact the dealer where you purchased this product to have the work done.

---

---

### USE SPECIFIED ACCESSORY PARTS AND INSTALL THEM SECURELY.

Be sure to use only the specified accessory parts. Use of other than designated parts may damage this unit internally or may not securely install the unit in place. This may cause parts to become loose resulting in hazards or product failure.

---

---

### ARRANGE THE WIRING SO IT IS NOT CRIMPED OR PINCHED BY A SHARP METAL EDGE.

Route the cables and wiring away from moving parts (like the seat rails) or sharp or pointed edges. This will prevent crimping and damage to the wiring. If wiring passes through a hole in metal, use a rubber grommet to prevent the wire's insulation from being cut by the metal edge of the hole.

---

---

### DO NOT INSTALL IN LOCATIONS WITH HIGH MOISTURE OR DUST.

Avoid installing the unit in locations with high incidence of moisture or dust. Moisture or dust that penetrates into this unit may result in product failure.

---

---

## Precautions

- Be sure to disconnect the cable from the (-) battery post before installing your DVE-5207. This will reduce any chance of damage to the unit in case of a short-circuit.
- Be sure to connect the colour coded leads according to the diagram. Incorrect connections may cause the unit to malfunction or damage to the vehicle's electrical system.
- When making connections to the vehicle's electrical system, be aware of the factory installed components (e.g. on-board computer). Do not tap into these leads to provide power for this unit. When connecting the DVE-5207 to the fuse box, make sure the fuse for the intended circuit of the DVE-5207 has the appropriate amperage. Failure to do so may result in damage to the unit and/or the vehicle. When in doubt, consult your ALPINE dealer.
- The DVE-5207 uses female RCA-type jacks for connection to other units (e.g. amplifier) having RCA connectors. You may need an adaptor to connect other units. If so, please contact your authorized ALPINE dealer for assistance.

---

---

### IMPORTANT

Please record the serial number of your unit in the space provided below and keep it as a permanent record. The serial number plate is located on the bottom of the unit.

SERIAL NUMBER: \_\_\_\_\_  
INSTALLATION DATE: \_\_\_\_\_  
INSTALLATION TECHNICIAN: \_\_\_\_\_  
PLACE OF PURCHASE: \_\_\_\_\_

# Installation

## Check accessory parts.

RCA-extension cable (for video signal 2m)



x 1

RCA-extension cable (for audio signal 2m)



x 1

Remote control

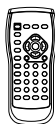

x 1

Battery (CR2025)



x 1

① Bracket



(1 each left and right)

② Floor base



x 2

③ Screw with double washer (M5 x 10)



x 4

④ Hex bolt (M6 x 50)



x 4

⑤ Flanged self-tapping screw (M5 x 15)



x 4

⑥ Spring washer (M6)



x 4

⑦ Flanged head hex nut (M6)



x 4

⑧ Wing nut (M6)



x 4

⑨ Velcro fastener



x 2

⑩ Mounting sleeve



x 1

⑪ Flat head screw (M5 x 8)



x 4

⑫ Front frame

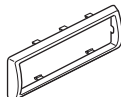

x 1

⑬ Hex nut (M5)



x 1

⑭ Bolt stud



x 1

⑮ Rubber cap



x 1

⑯ Hex bolt (M5 x 7)



x 1

## Installation Location

Before deciding on the mounting location, check that opening and closing the display will not hamper the gear shift in any position.

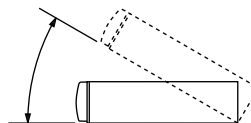

- Install at an angle of within 35 degrees from the horizontal.

Do not mount the unit in a location of extreme temperature fluctuations (such as near an air conditioner or heater vent). Disc read failures or other problems may result. If mounted in such location, failures such as "Disc can not read." or other failure may occur.

## When installing into the dash board

### Caution for installation

Be sure to remove the mounting sleeve squarely from the product, refer to "Removal" (page 30).

1

Mounting sleeve ⑩ (Included)

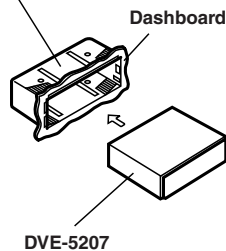

- Remove the wrapping from the unit.

2

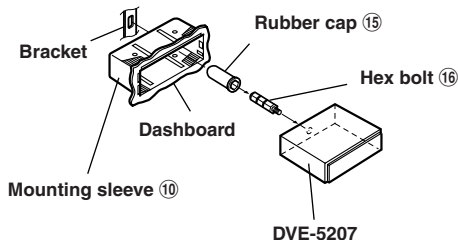

Slide the mounting sleeve into the dashboard and fix it with the metal shackles.

Continued

3

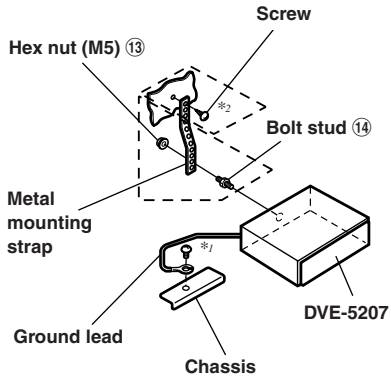

Reinforce the unit with the metal mounting strap (not supplied). Secure the ground lead of the unit to a clean metal spot using a screw\*1 already attached to the vehicle's chassis.

- For the screw marked\*2, use an appropriate screw for the chosen mounting location.

Connect each input lead coming from an amplifier or equalizer to the corresponding output lead coming from the left rear of the DVE-5207. Connect all other leads of the DVE-5207 according to details described in the "Connections" section.

4

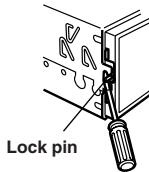

Slide the DVE-5207 into the dashboard. When the unit is in place, make sure the locking pins are fully seated in the down position. This can be done by pressing firmly in on the unit while pushing the locking pin down with a small screwdriver. This ensures that the unit is properly locked and will not accidentally come out from the dashboard. Install the Detachable Front Panel.

**Removal**

- 1 Use a small screwdriver (or similar tool) to push the locking pins to the "up" position (see above drawing). As each pin is unlocked, gently pull out on the unit to make sure it does not re-lock before unlocking the second pin.
- 2 Pull the unit out, keeping it unlocked as you do so.

**<JAPANESE CAR>**

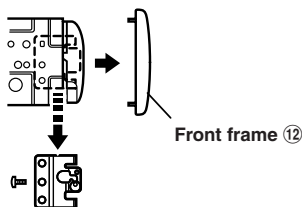

Screws (M5 × 8) (Included with the head unit)

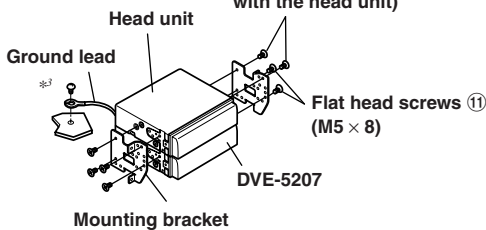

- Secure the ground lead of the unit to a clean metal spot using a screw\*3 already attached to the vehicle's chassis.

**When mounting using Velcro fastener**

- 1 **Place Velcro fastener ⑨.**  
Attach two pieces of Velcro fastener ⑨ with the rough side facing toward the DVD unit.
- 2 **Put on two pieces of Velcro fastener ⑨ on the mounting positions.**  
Put on two pieces of the Velcro fastener (soft one) ⑨ on the mounting positions and mount the unit.

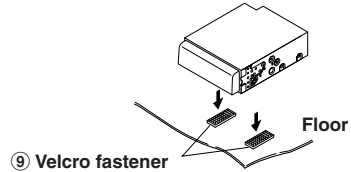

**When mounting to the rear deck**

- 1 **Mount the brackets ① on the unit.**  
Mount the brackets ① at both sides of the unit with screws with double washer (M5 × 10) ③.

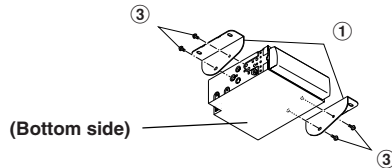

- 2 **Attach the unit to the rear deck.**  
Attach the unit securely with hex bolts (M6 × 50) ④, flanged head hex nut (M6) ⑦, spring washers (M6) ⑥, and wing nuts (M6) ⑧.

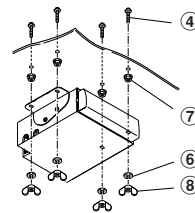

**When mounting the unit directly on the floor**

- 1 **Mount the brackets ① on the unit.**  
Mount the brackets ① at both sides of the unit with screws with double washer (M5 × 10) ③.

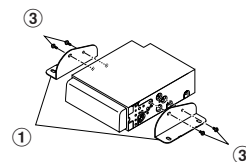

## 2 Mount the unit on the floor.

Mount the unit on the floor with flanged selftapping screws (M5 x 15) ⑤ and spring washers (M6) ⑥.

**Warning:** Do not damage pipe or wiring when drilling holes.

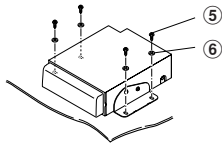

### When mounting with floor base brackets

## 1 Mount the brackets ① on the unit.

Mount the brackets ① at both sides of the unit with screws with double washer (M5 x 10) ③.

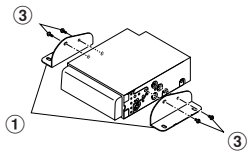

## 2 Determine mounting position of the unit under the carpet.

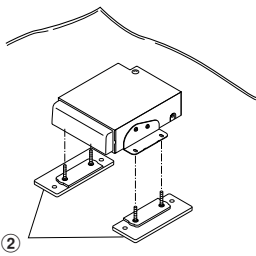

## 3 Cut the carpet in "x" shape with a cutter and insert the floor base ② from the underside of the carpet, peel off the protective seal on the back of the floor base, then put the floor base on the floor.

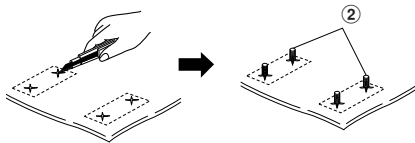

## 4 Mount the unit on the carpet with spring washer (M6) ⑥ and wing nuts (M6) ⑧.

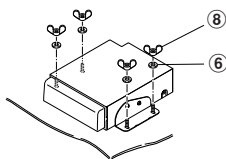



# Connections

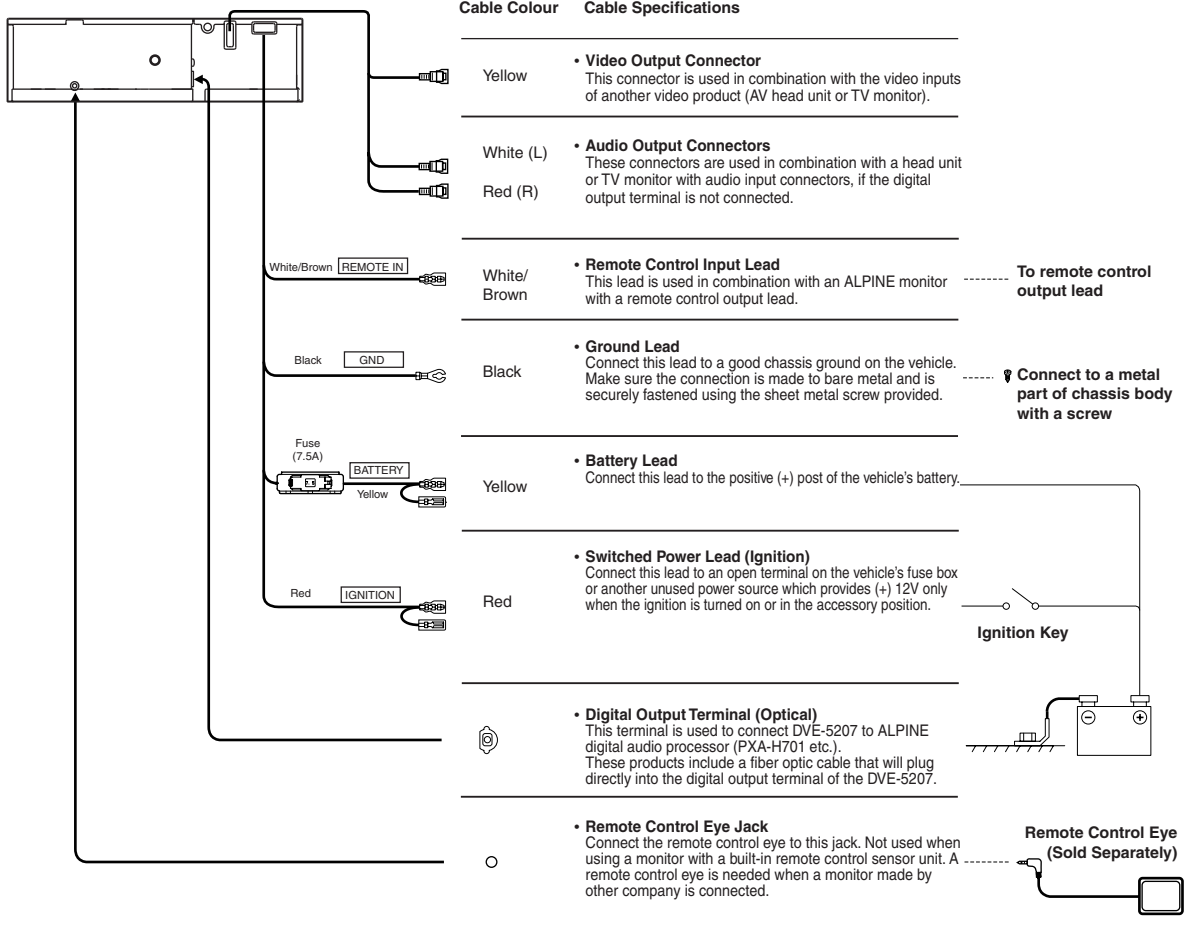

- Connect properly.  
Never connect to parts other than the ones indicated in these operating instructions.
- Also refer to the operating instructions of the other products in the system.
- A remote control eye is needed when a monitor made by another company is connected.

## System Example

### Connecting an Ai-NET compatible Head Unit, Digital Audio Processor (PXA-H701, PXA-H900, etc.) and ALPINE TV Monitor

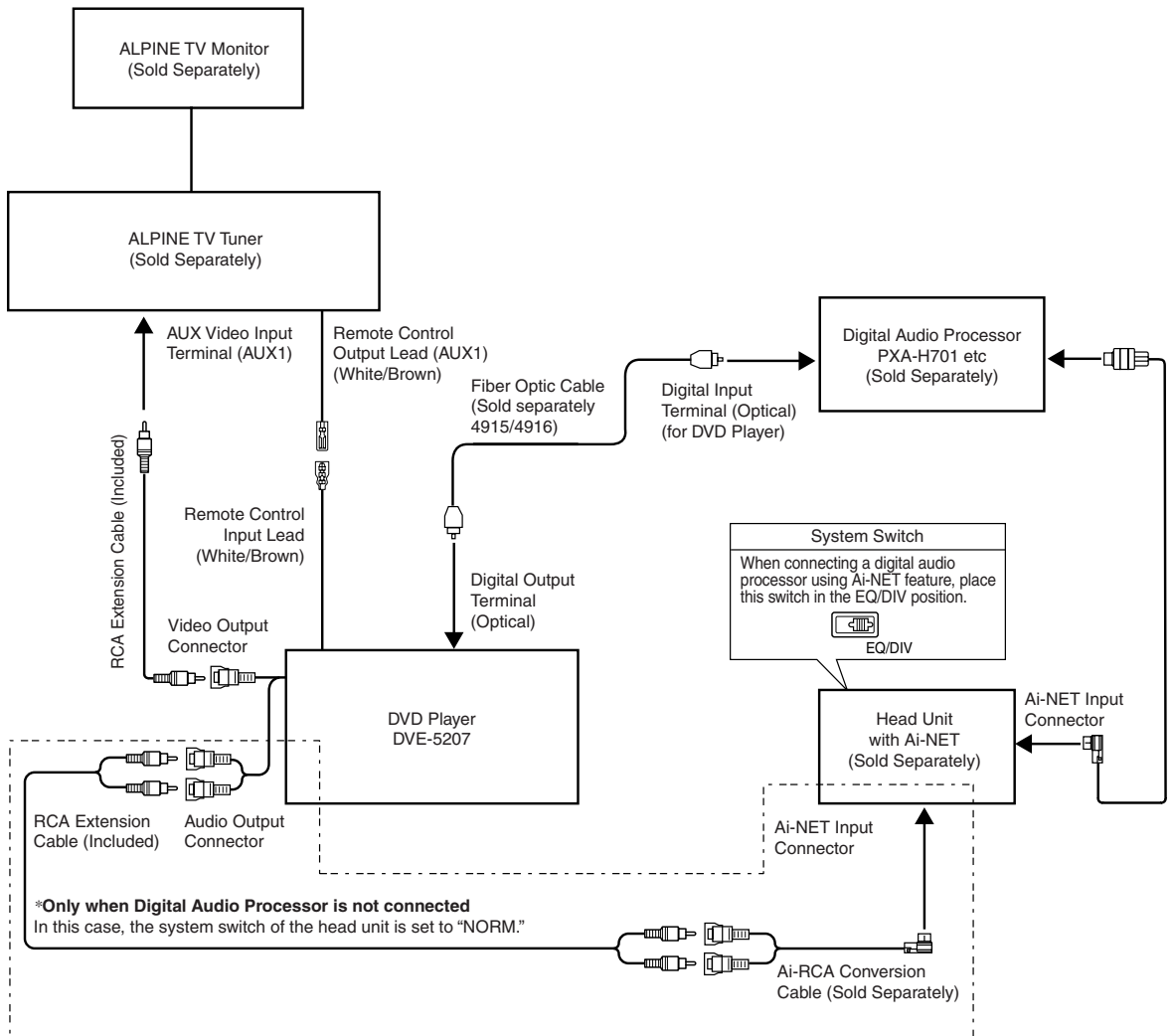

- Also refer to the operating instructions of the other products in the system.

## Connecting Another Manufacturer's TV Monitor

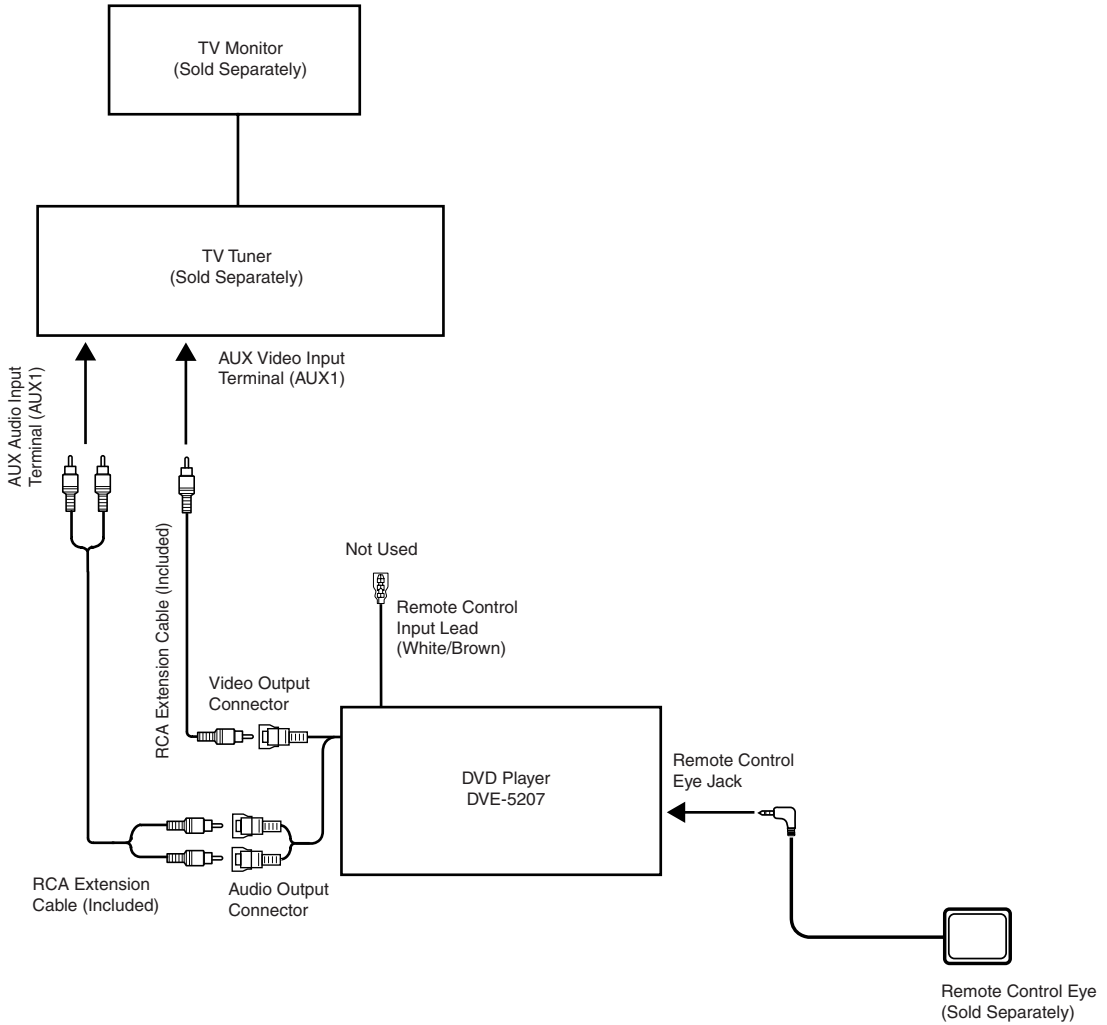

- Remote control eye is required.
- Also refer to the operating instructions of the other products in the system.
- When you connecting another manufacturer's TV monitor, the remote control input lead (White/Brown), is not used.

## Operating the DVE-5207 Video Player

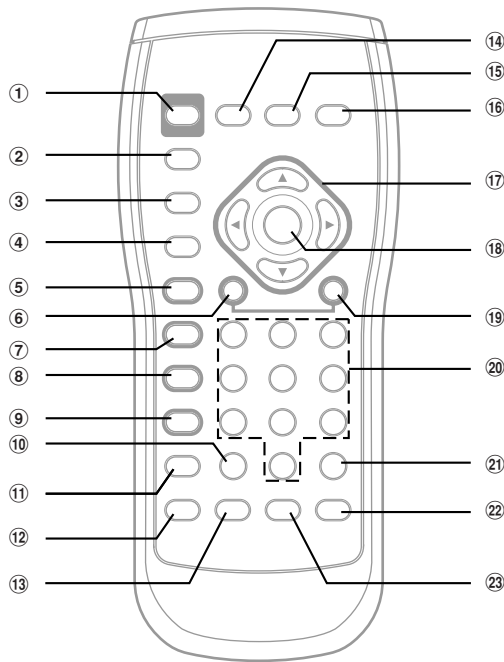

- ① **PWR button**  
Turns the power ON and OFF.
- ② **SETUP button**  
Displays the SETUP (initial setting) screen.
- ③ **LIST button**  
MP3 Folder and File Search.
- ④ **RETURN button**  
Returns to the selection screen just prior to the current screen.
- ⑤ **▶/II button**  
Switches between play and pause.
- ⑥ **◀◀ button**  
CD mode: Press the button to go back to the beginning of the current track. Press and hold to fast reverse.  
MP3 mode: Press the button to go back to the beginning of the current file. Press and hold to fast reverse.  
DVD/Video CD mode:
  - Move to the desired position on the disc.
  - During playback, press and hold for more than 1 second to reverse the disc at double speed. Hold for more than 5 seconds to reverse the disc at 8 times the normal speed.
  - When pressed and held in while in the pause mode, the disc is played in reverse slow motion at 1/8th the normal speed. When held in for 5 more seconds, the reverse slow motion speed switches to 1/2 the normal speed (DVD only).
  - The picture is reversed by one frame each time the button is pressed in the pause mode (DVD only).
- ⑦ **■ button**  
Performs PRE STOP. Press again to cancel PRE STOP and stop the playback.

- ⑧ **FOLDER ▲ button**  
Selects MP3 folders.
  - ⑨ **FOLDER ▼ button**  
Selects MP3 folders.
  - ⑩ **CLR (ALL CLR) button**  
Removes numbers (one character at a time) that have been selected and input. Press and hold for 2 seconds. All the characters which were selected and input are erased.
  - ⑪ **REPEAT button**  
Repeats playback.
  - ⑫ **M.I.X. button**  
M.I.X. play for CDs and MP3
  - ⑬ **AUDIO button**  
Switches the audio tracks.
  - ⑭ **DISPLAY button**  
Displays playback status on the screen.
  - ⑮ **MENU button**  
Displays the DVD menu.
  - ⑯ **TOP M. button**  
Displays the title Menu.
  - ⑰ **▲, ▼, ◀, ▶**  
Selects the items displayed on the screen.
  - ⑱ **ENT. button**  
Determines the selected item.
  - ⑲ **▶▶I button**  
CD mode: Press the button to advance to the beginning of the next track. Press and hold to fast forward.  
MP3 mode: Press the button to advance to the beginning of the next file. Press and hold to fast forward.  
DVD/Video CD mode:
    - Move to the desired position on the disc.
    - During playback, press and hold for more than 1 second to forward the disc at double speed. Hold for more than 5 seconds to forward the disc at 8 times the normal speed.
    - When pressed and held in while in the pause mode, the disc is played in slow motion at 1/8th the normal speed. When held in for 5 more seconds, the slow motion speed switches to 1/2 the normal speed.
    - The picture is forwarded by one frame each time the button is pressed in the pause mode.
  - ⑳ **Numeric Keypad**  
Inputs numbers
  - ㉑ **V.OUT button**  
This button is not used.
  - ㉒ **ANGLE button**  
Switches the angle.
  - ㉓ **SUBTITLE button**  
Switches the subtitle.
- Operation may not be possible depending on the type of disc and the playback conditions. At such a time the following mark is displayed on the screen: Ⓞ

# Appendix

## Product Information Card

## Produkt-Informationskarte

## Carte d'informations sur le produit

## Tarjeta de información del producto

### English

Filling in this Product Information Card is voluntary. If you fill in this card and send it to Alpine, your data will be tabulated into reference data for future Alpine product development. In addition, in the future you may receive information about new products or Survey Mail requesting additional opinions about Alpine products or services. If you agree to the above term, please sign your name in the indicated space and return the card. Any additional comments or inquiries may be sent to: Person in charge of Customer Service department Alpine Electronics (Europe) GmbH.  
Frankfurter Ring 117, 80807 München, Germany  
Phone: +49-(0)89-32 42 640

### Deutsch

Das Ausfüllen dieser Produktinformations-Karte ist freiwillig. Sollten Sie diese Karte vervollständigen, so werden die Daten für zukünftige Produktentwicklungen von Alpine als Referenzdaten herangezogen. Ebenso können Sie in der Zukunft Informationen über neue Alpine Produkte erhalten oder uns auch Ihre Meinung über Alpine Produkte und Dienstleistungen im Rahmen von Kunden-Befragungen mitteilen. Stimmen Sie dem Kontakt durch Alpine zu, so würden wir Sie bitten, in dem dafür vorgesehenen Feld zu unterschreiben und die Karte kostenfrei an uns zurückzuschicken. Zusätzliche Kommentare und Meinungen können Sie gerne an den zuständigen Kontakt im Kundendienst Alpine Electronics (Europe) GmbH senden.  
Frankfurter Ring 117, 80807 München, Germany  
Phone: 089-32 42 640

### Français

En remplissant volontairement cette fiche, et en l'envoyant à Alpine, vous acceptez que ces informations soient utilisées par Alpine, dans le cadre de développement de nouveaux produits. Par ailleurs, vous autorisez Alpine à solliciter votre opinion par mailing sur de nouveaux produits ou services. Si vous acceptez les termes ci-dessus, veuillez signer cette carte à l'endroit indiqué, et nous la retourner. Tout autre commentaire ou demande doit être adressé à l'attention de: Responsable du service consommateur Alpine Electronics (Europe) GmbH.  
Frankfurter Ring 117, 80807 München, Germany  
Phone: +49-(0)89-32 42 640

### Español

El envío de la información solicitada es voluntario. Si Vd. nos la remite, será utilizada de modo confidencial para el desarrollo de futuros productos Alpine. Si Vd. desea recibir información sobre nuevos productos de nuestra gama, indique su nombre en el espacio designado y remitanos la tarjeta. Cualquier solicitud adicional puede ser enviada a: Persona responsable del Servicio de Atención al Cliente de Alpine Electronics (Europe) GmbH.  
Frankfurter Ring 117, 80807 München, Germany  
Phone: +49-(0)89-32 42 640

#### Q1. PRODUCT PURCHASED

1. Cassette Player
2. CD Player
3. MD Player
4. DVD Player
5. CD Changer
6. Amplifier
7. Speaker
8. Subwoofer
9. Monitor Controller
10. Video Monitor
11. Navigation
12. Processor/Equalizer
13. CD/Video CD Changer
14. Other \_\_\_\_\_

#### Q2. MODEL NUMBER: \_\_\_\_\_

#### Q3. DATE OF PURCHASE:

Month: \_\_\_\_\_ Year: \_\_\_\_\_

#### Q4. If navigation system, which monitor?

1. Alpine → (Model No.) \_\_\_\_\_
2. Other → (Brand Name) \_\_\_\_\_

#### Q5. STORE TYPE WHERE PURCHASED:

1. Car Audio Specialist
2. Audio/Video Store
3. Electronics/Appliance Store
4. Car Accessories Shop
5. Other \_\_\_\_\_

#### Q6. Type of vehicle in which this unit is installed:

Make: \_\_\_\_\_ Model: \_\_\_\_\_  
Purchased: \_\_\_\_\_ Model: \_\_\_\_\_  
Year: \_\_\_\_\_ Year: \_\_\_\_\_

#### Q7. How was this vehicle purchased?

1. Purchase
2. Lease

#### Q8. Purpose of buying this unit?

1. Addition
  2. Replacement
- ↓
- Previous brand replaced?

1. Factory installed
2. Alpine
3. Other → (Brand Name) \_\_\_\_\_

#### Q9. Have you purchased Alpine products before?

1. First time
2. Two or More times

#### Q10. When you purchased this Alpine unit, did you compare it with other brand?

1. Yes → (Brand Name) \_\_\_\_\_
2. No

#### Q11. GENDER

1. Male
2. Female

#### Q12. AGE \_\_\_\_\_

#### Q13. MARITAL STATUS

1. Single
2. Married

#### Q14. OCCUPATION

1. Company Owner/Self-employed/  
Freelance
2. Manager
3. Company Employee
4. Civil Servant
5. Educator
6. Student
7. Other \_\_\_\_\_

#### Q15. Comments \_\_\_\_\_

#### Q1. gekauftes Gerät

1. Kassetten-Spieler
2. CD-Spieler
3. MD-Spieler
4. DVD-Spieler
5. CD-Wechsler
6. Verstärker
7. Lautsprecher
8. Subwoofer
9. Monitor-Controller
10. Video-Monitor
11. Navigationssystem
12. Prozessor/Equalizer
13. CD/Video-CD-Wechsler
14. andere \_\_\_\_\_

#### Q2. Modellnummer: \_\_\_\_\_

#### Q3. Kaufdatum:

Monat: \_\_\_\_\_ Jahr: \_\_\_\_\_

#### Q4. Falls Navigationssystem: Welcher Monitor?

1. Alpine → (Modellnr.) \_\_\_\_\_
2. Anderer Hersteller →  
(Herstellername) \_\_\_\_\_

#### Q5. Art des Geschäfts, in dem Sie das Gerät gekauft haben:

1. Spezialist für Auto-Audioanlagen
2. Audio/Video-Geschäft
3. Elektro-Geschäft
4. Autozubehör-Geschäft
5. Anderer Hersteller \_\_\_\_\_

#### Q6. Art des Fahrzeugs, in dem das Gerät installiert wurde:

Marke: \_\_\_\_\_ Modell: \_\_\_\_\_  
gekauft im \_\_\_\_\_  
Jahr: \_\_\_\_\_ Baujahr: \_\_\_\_\_

#### Q7. Wie haben Sie das Fahrzeug gekauft?

1. Kauf
2. Leasing

#### Q8. Zweck des Kaufs dieses Geräts?

1. Zusätzlich
  2. Austausch
- ↓
- Marke des ausgetauschten Geräts?

1. Serienmäßige Ausstattung
2. Alpine
3. Anderer Hersteller →  
(Herstellername) \_\_\_\_\_

#### Q9. War dies das erste Mal, dass Sie ein Alpine-Gerät gekauft haben?

1. Erstes Mal
2. Zweites Mal oder öfter

#### Q10. Haben Sie dieses Alpine-Gerät vor dem Kauf mit Geräten anderer Hersteller verglichen?

1. Ja → (Herstellername) \_\_\_\_\_
2. Nein

#### Q11. Geschlecht

1. Männlich
2. Weiblich

#### Q12. Alter \_\_\_\_\_

#### Q13. Familienstand

1. Ledig
2. Verheiratet

#### Q14. Beruf

1. Selbständige/Firmeninhaber/treiberberuflich  
Tätige
2. Leitende Angestellte
3. Sonstige Angestellte
4. Beamte
5. Schulbildung
6. Studium
7. Sonstige \_\_\_\_\_

#### Q15. Kommentar: \_\_\_\_\_

#### Q1. PRODUIT ACHETE

1. Lecteur de cassette
2. Lecteur de CD
3. Lecteur MD
4. Lecteur DVD
5. Changeur de CD
6. Amplificateur
7. Haut-parleur
8. Haut-parleur de graves
9. Station Multimedia
10. Moniteur Vidéo
11. Navigation
12. Processeur/Egaliseur
13. Changeur de CD/CD Vidéo
14. Autre \_\_\_\_\_

#### Q2. NUMERO DU MODELE: \_\_\_\_\_

#### Q3. DATE D'ACHAT:

Mois: \_\_\_\_\_ Année: \_\_\_\_\_

#### Q4. Si c'est un système de navigation, quel moniteur?

1. Alpine → (N° du modèle) \_\_\_\_\_
2. Autre → (Marque) \_\_\_\_\_

#### Q5. TYPE DE MAGASIN OU VOUS AVEZ ACHETE LE PRODUIT:

1. Spécialiste autoradio
2. Magasin audio/vidéo
3. Magasin d'électronique/appareils
4. Magasin d'accessoires automobiles
5. Autre \_\_\_\_\_

#### Q6. Type de véhicule dans lequel cet appareil est installé:

Marque: \_\_\_\_\_ Modèle: \_\_\_\_\_  
Année \_\_\_\_\_ Année du  
d'achat: \_\_\_\_\_ modèle: \_\_\_\_\_

#### Q7. Comment avez-vous acheté ce véhicule?

1. Achat
2. Location-bail

#### Q8. Pourquoi avez-vous acheté cet appareil?

1. Addition
  2. Remplacement
- ↓
- Marque précédente remplacée?

1. Installée en usine
2. Alpine
3. Autre → (Marque) \_\_\_\_\_

#### Q9. Aviez-vous déjà acheté des produits Alpine?

1. Première fois
2. Deux fois ou plus

#### Q10. Lorsque vous avez acheté ce produit Alpine, l'avez-vous comparé à une autre marque?

1. Oui → (Marque) \_\_\_\_\_
2. Non

#### Q11. SEXE

1. Masculin
2. Féminin

#### Q12. AGE \_\_\_\_\_

#### Q13. SITUATION DE FAMILLE

1. Célibataire
2. Marié

#### Q14. PROFESSION

1. Entrepreneur/Travailleur indépendant/  
Free-lance
2. Directeur
3. Employé de bureau
4. Fonctionnaire
5. Educateur
6. Etudiant
7. Autre \_\_\_\_\_

#### Q15. Commentaires \_\_\_\_\_

#### Q1. Producto Comprado

1. Radio/Cassette
2. Radio/CD
3. Reproductor de MD
4. Reproductor de DVD
5. Cambiador de CD
6. Amplificador
7. Altavoz
8. Subwoofer
9. Monitor de control
10. Monitor de video
11. Sistema de navegación
12. Procesador/Equalizador
13. Cambiador de CD/Video CD
14. Otros \_\_\_\_\_

#### Q2. Número de modelo: \_\_\_\_\_

#### Q3. Fecha de compra:

Mes: \_\_\_\_\_ Año: \_\_\_\_\_

#### Q4. En caso de sistema de navegación, ¿qué monitor?

1. Alpine → (N° de modelo) \_\_\_\_\_
2. Otro → (Nombre de marca) \_\_\_\_\_

#### Q5. TIPO DE TIENDA DONDE COMPRÓ:

1. Especialista en audio de automóviles
2. Tienda de audio/vidéo
3. Tienda de electrónica/electrodomésticos
4. Tienda de accesorios automovilísticos
5. Otros \_\_\_\_\_

#### Q6. Tipo de vehículo en que la unidad está instalada:

Marca: \_\_\_\_\_ Modelo: \_\_\_\_\_  
Año de \_\_\_\_\_ Año del  
compra: \_\_\_\_\_ modelo: \_\_\_\_\_

#### Q7. ¿Cómo fue comprado este vehículo?

1. compra
2. Leasing

#### Q8. ¿Propósito de comprar esta unidad?

1. Mejora del sistema
  2. Sustitución
- ↓
- ¿Sustitución de marca anterior?

1. Instalada en la fábrica
2. Alpine
3. Otros → (Nombre de marca) \_\_\_\_\_

#### Q9. ¿Ha comprado Vd. productos Alpine anteriormente?

1. Primera vez
2. Dos o más veces

#### Q10. Cuando usted compró esta unidad Alpine, ¿la comparó con otros fabricantes?

1. Si → (Nombre de marca) \_\_\_\_\_
2. No

#### Q11. SEXO

1. Masculino
2. Femenino

#### Q12. Edad \_\_\_\_\_

#### Q13. Estado civil

1. Soltero
2. Casado

#### Q14. Ocupación

1. Propietario de empresa/Autónomo/  
Profesional independiente
2. Gerente
3. Empleado de compañía
4. Empleado público
5. Profesor
6. Estudiante
7. Otros \_\_\_\_\_

#### Q15. Comentarios \_\_\_\_\_

# Scheda informazioni prodotto

## Italiano

La compilazione di questa formulario è volontaria. Se compilate questo formulario, ritornandolo ad Alpine, i Vostri dati saranno raccolti in un file di riferimento per lo sviluppo dei nuovi prodotti Alpine. In aggiunta Voi potrete ricevere in futuro informazioni riguardanti i nuovi prodotti o la richiesta di una Vostra opinione circa i prodotti o i servizi forniti da Alpine. Se siete d'accordo, Vi preghiamo di ritornarci il formulario compilato negli appositi spazi con i Vostri dati. In caso desideriate fornire altri commenti o richiedere informazioni aggiuntive, potete indirizzare il tutto a : Responsabile dipartimento Servizio Clienti Alpine Electronics (Europe) GmbH.  
Frankfurter Ring 117, 80807 München, Germany  
Phone: +49-(0)89-32 42 640

### Q1. PRODOTTO ACQUISTATO

1. Lettore di cassette
2. Lettore CD
3. Lettore MD
4. Lettore DVD
5. CD Changer
6. Amplificatore
7. Altoparlante
8. Subwoofer
9. Radio Monitor
10. Monitor video
11. Sistema di navigazione
12. Processore/equalizzatore
13. Cambia CD/Video CD
14. Altro \_\_\_\_\_

### Q2. NUMERO MODELLO: \_\_\_\_\_

### Q3. DATA DI ACQUISTO:

Mese: \_\_\_\_\_ Anno: \_\_\_\_\_

### Q4. In caso di acquisto di un sistema di navigazione, quale monitor possiede?

1. Alpine → (No. Modello) \_\_\_\_\_
2. Altro → Nome marca \_\_\_\_\_

### Q5. NEGOZIO DI ACQUISTO:

1. Specialista Car Stereo
2. Negozio di audio/video
3. Negozio di elettronica/elettrodomestici
4. Negozio accessori automobile
5. Altro \_\_\_\_\_

### Q6. Tipo di veicolo posseduto:

Marca: \_\_\_\_\_ Modello: \_\_\_\_\_

Anno \_\_\_\_\_ Anno \_\_\_\_\_

acquisto: \_\_\_\_\_ modello: \_\_\_\_\_

### Q7. Modalità acquisto

1. Acquisto
2. Leasing

### Q8. Scopo acquisto

1. Aggiunta
  2. Sostituzione
- ↓
- Marca sostituita
  - 1. Installato di fabbrica
  - 2. Alpine
  - 3. Altro → (Nome marca) \_\_\_\_\_

### Q9. Avevate già acquistato prodotti Alpine?

1. No
2. Due o tre volte

### Q10. Nell'acquistarlo, avete paragonato questo prodotto ad un'altra marca?

1. Sì → (Nome marca) \_\_\_\_\_
2. No

### Q11. SESSO

1. Maschile
2. Femminile

### Q12. ETÀ \_\_\_\_\_

### Q13. STATO CIVILE

1. Celibe/nubile
2. Coniugato/coniugata

### Q14. LAVORO

1. Proprietario di azienda/artigiano/libero professionista
2. Manager
3. Impiegato
4. Impiegato statale
5. Insegnante
6. Studente
7. Altro \_\_\_\_\_

### Q15. Commenti \_\_\_\_\_

- ◆ I agree to the above stated terms of the Alpine Product Information Card.
- ◆ Ich stimme dem Kontakt durch Alpine für Informations- und Befragungszwecke zu.
- ◆ J'accepte les termes de cette carte d'information produit Alpine.
- ◆ Estoy conforme con los términos de la tarjeta de información sobre producto de Alpine.
- ◆ Accetto i termini della scheda informazioni prodotti Alpine.

\_\_\_\_\_ (Date/Datum/Date/Fecha/Data)

\_\_\_\_\_ (Signature/Unterschrift/Signature/Firma)

### Name/Nom/Nombre/Nome

\_\_\_\_\_  
(First Name/Vorname/Prénom/Primer nombre/Nome)

\_\_\_\_\_  
(Surname/Familiennome/Nom de famille/Apellido/Cognome)

### Home Address/Privatanschrift/Adresse/Dirección/Indirizzo

\_\_\_\_\_  
(Street/Straße/Rue/Calle/Via) (Post Code/Postleitzahl/Code postal/Código postal/Codice postale)

\_\_\_\_\_  
(Town/City/Stadt/Ville/Ciudad/Città) (Country/Land/Pays/Pais/Paese)

**Telephone Number:** \_\_\_\_\_

**E-Mail/Correo electrónico:** \_\_\_\_\_

<b>Q1</b> NO. Other	<b>Q2</b>
------------------------	-----------

<b>Q3</b> Month 	Year 	<b>Q4</b> NO.1. Model No. 	NO.2. Brand Name 
---------------------	----------	-------------------------------	----------------------

<b>Q5</b> NO. Other	<b>Q6</b> Make: Purchased Year:	Model: ModelYear:
------------------------	------------------------------------	----------------------

<b>Q7</b> NO. 	<b>Q8</b> NO. 1 <input type="checkbox"/> Previous brand replaced. Brand Name 2 <input type="checkbox"/> 1. 2. 3. <input type="checkbox"/>
-------------------	--

<b>Q9</b> NO. 	<b>Q10</b> 1 <input type="checkbox"/> Brand Name NO. 2 _____	<b>Q11</b> NO. 
-------------------	---	--------------------

<b>Q12</b>                 years old	<b>Q13</b> NO. 	<b>Q14</b> NO. Other
--------------------------------------	--------------------	-------------------------

**Q15** Comments  
 \_\_\_\_\_  
 \_\_\_\_\_

**LUFTPORT**  
PAR AVION  
PRIORITAIRE

NE PAS AFFRANCHIR  
  
NICHT FREIMACHEN  
NO STAMP REQUIRED

---

REPOSE PAYEE/ WERBEANTWORT  
ALLEMAGNE

---

ALPINE ELECTRONICS (EUROPE) GmbH  
Frankfurter Ring 117, 80807 München,  
Germany