



KIT-700LEON

Seat Leon 2013>



INSTRUCTION MANUAL

Installation Guide



Part No: KIT-700LEON



1. Remove the plastic trim from around the head unit and air vents using a plastic removal tool.



2. Insert 4 release keys into the head unit (as shown in the picture) then remove the head unit making sure you disconnect all the wiring connectors from the back of the head unit.



3. Image of the head unit removed and all wiring connectors disconnected.



4. Fascia kit contents - Fascia Trim, Screws. Brackets.



5. Screw the brackets to the inside of the fascia using the screws provided.



6. Align the bracket screws holes up with the head units screw holes. Please make sure the head units face is flush with the fascia trim and then secure in position with the screws provided.

ABOUT

The Alpine APF-V1G7 Infodapter for VW MIB platform vehicles allows vehicle information such as climate control, parking sensors and heated seats and vehicle menus to be displayed on the Alpine iLX-700 head unit. The APF-V1G7 also allows the use of the steering wheel controls with the iLX-700 head unit.

DIP SWITCH SETTINGS

See Fig 1.

Up = Off, Down = On

1: Not applicable. (This should be kept in the Up/Off position)

2: Not applicable.

3: Resets the display settings back to default. If the display settings have been manipulated in a way that it is no longer possible to make adjustments, change the DIP switch #3 from Off to On and back. This will reset the screen settings to the factory defaults. During this procedure the screen background will change to red. While the background is red, no settings can be made.

4: Not applicable. (This should be kept in the Up/Off position)

Interface Connections

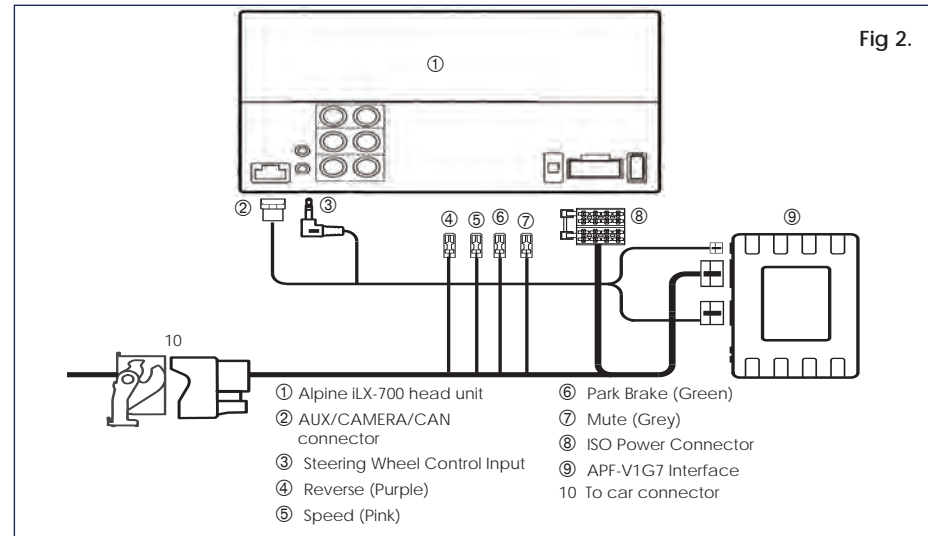
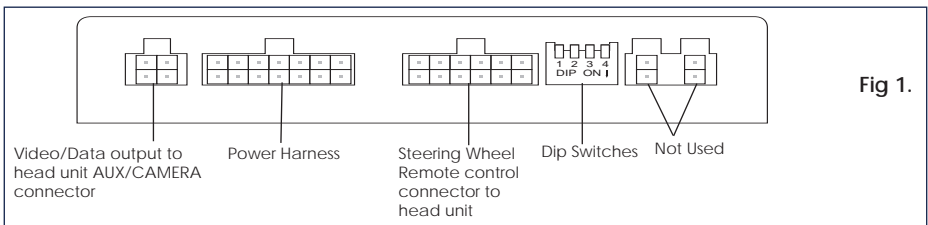

iLX-700 Setup

The iLX-700 must be configured for first time use with the APF-V1G7 interface:

1. From the home screen, enter Setup menu and select '**Application**'.
2. From the Application menu, select '**Auxilliary(AUX)**'.
3. From the Auxilliary (AUX) menu, go to '**Aux Name**' and select '**DVB-T**'.
Go to '**Direct Touch**' and select '**ON**'.
4. The iLX-700 is now setup to work with the APF-V1G7.

Configuration Menu

To access the APF-V1G7 menu, **push the iLX-700 'HOME' button on the front of the head unit**. Select the '**DVB-T**' icon and use the touchscreen to select items within the menu.

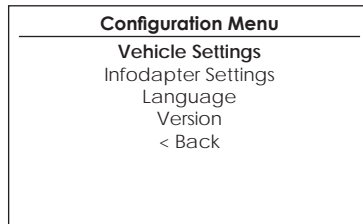

- **Vehicle Settings**
Vehicle settings can be adjusted via the menu. All vehicle setup options that were available with the original head unit, are now available through the iLX-700 head unit. See the vehicle handbook for more information regarding these features.

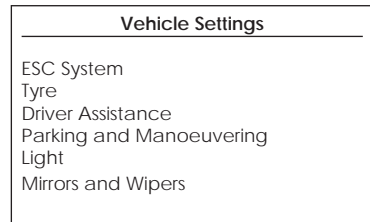

- **Infodapter Settings**
 - o **Screen Size/Position** -
The APF-V1G7 is setup by default for the iLX-700, however the screen size/ position can be adjusted to suit the user requirements.

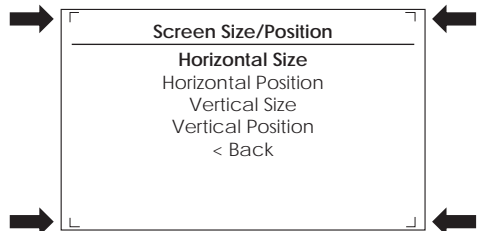

Configuration Menu...continued

- o Picture Settings - Adjust Brightness, contrast and colour saturation.

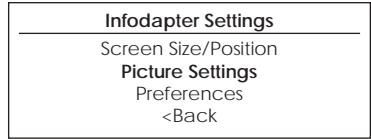

- o Preferences -

Driver Position - Select Left or Right depending upon vehicle configuration.

Park Brake Source - Set to Speed, Brake or Always On.

Climate - Select how long the climate display should be shown on the head unit when adjusted. Select between the range of 3 seconds and 30 seconds.

Restore factory settings - Reverts all Infodapter settings to factory defaults. (This does not restore vehicle settings)

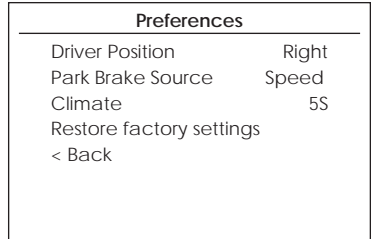

- o Driving Mode - The driving mode button can be used as normal. The graphic for the mode will be shown on the head unit.



- o Park Assist - The park assist button can be used as normal to activate/deactivate park assist. The graphic will be shown on the head unit.

Legal Information

Please consult the relevant road traffic laws governing the country in which this product is being operated. No liability is accepted for material damage, loss or personal injury, directly or indirectly, from installation and operation of this product. This product should only be operated when safe to do so.