

Contents

Operating Instructions



WARNING

WARNING	3
CAUTION	3
PRECAUTIONS	3

Getting Started

Turning Power On and Off	6
Initial System Start-Up	6
Opening and Closing the Movable Display	6
Display Tilt Adjustment	6
Adjusting Volume	6
Changing the Display Type (CDA-9833R only)	6
Switching the Display modes (CDA-9835R only)	6
Detaching and Attaching the Front Panel	7

Radio

Listening to Radio	7
Manual Storing of Station Presets	8
Automatic Memory of Station Presets	8
Tuning to Preset Stations	8
Station Title Search Function	8
Frequency Search Function	8

RDS

Setting RDS Reception Mode and Receiving RDS Stations	9
Recalling Preset RDS Stations	9
Receiving RDS Regional (Local) Stations	9
PI SEEK Setting	10
Receiving Traffic Information	10
PTY (Programme Type) Tuning	10
Receiving Traffic Information While Playing CD or Radio	11
Priority PTY (Programme Type)	11
Displaying Radio Text	12

CD/MP3/WMA

Playback	12
Playing back a Playlist	13
Repeat Play	14
M.I.X. (Random Play)	14
Scanning Programmes	15
Searching from CD Text	15
File/Folder Name Search (concerning MP3/ WMA)	15
Quick Search	15
About MP3/WMA	16

Sound Setting

Adjusting Balance (Between Left and Right)/ Fader (Between Front and Rear)/Defeat	17
Equalizer Presets	18
Adjusting and Storing the Equalizer Curve	18
Recalling the Stored Equalizer Curve	18
About the Crossover	18
Adjusting and Storing the Crossover Settings ...	19
Recalling the Stored Crossover Settings	20
About Time Correction	20
Bass Focus	21
Adjusting and Storing the Time Correction	22
Recalling the Stored Time Correction Settings	22
Setting the MX Mode	23

Other Functions

Displaying the Title/Text	23
Titling Discs/Stations	25
Erasing Disc Title/Station Title	25
Blackout Mode On and Off	25
Setting an Amplifier Link	26
Displaying the External Amplifier Information	26
Setting the Multicolour Illumination	27
Changing the Lighting Colour of All the Buttons	27
Verifying the Software Version	27

Windows Media and the Windows logo are trademarks, or registered trademarks of Microsoft Corporation in the United States and/or other countries.

i-Personalize™ Operation

About i-Personalize™	28
Data Downloading	28

SETUP

Sound Customizing

Adjusting Source Signal Levels	29
Switching the Tuner Mode	29
Subwoofer On and Off	29
Setting the Subwoofer Output	29
Setting the Response Slope for the High Range Speaker (TW SETUP)	29
Sound (Beep) Guide Function	29

Visual Customizing

Dimmer Control	29
Scroll Setting	30
Switching the Character Font (CDA-9833R only)	30
Adjusting Display Contrast (CDA-9833R only)	30
Switching the Animation Display type (CDA-9835R only)	30
Demonstration	30

MP3/WMA

Playing MP3/WMA Data	30
----------------------------	----

External Device

Turning Mute Mode On/Off	30
Setting the AUX Mode (V-Link)	30
Connecting to an External Amplifier	30
Setting the Temperature Display for the External Amplifier	30
Setting Tone Defeat for External Devices	30

MobileHub™ Link Operation (Optional)

About MobileHub™ Link	31
Telephone Mode ON/OFF	31
Incoming Calls	31
Setting the Automatic Calling	31
Calling	32
SMS (Short Message Service) Operation	32

Changer (Optional)

Controlling CD Changer (Optional)	33
Playing MP3 Files with the CD Changer (Optional)	33
Multi-Changer Selection (Optional)	33

Remote Control

Controls on Remote Control	34
Operating the Audio Processor	34
Battery Replacement	35

Information

In Case of Difficulty	35
Specifications	37

Installation and Connections

Warning	38
Caution	38
Precautions	38
Installation	39
Connections	40

Operating Instructions

WARNING

WARNING

This symbol means important instructions. Failure to heed them can result in serious injury or death.

DO NOT OPERATE ANY FUNCTION THAT TAKES YOUR ATTENTION AWAY FROM SAFELY DRIVING YOUR VEHICLE.

Any function that requires your prolonged attention should only be performed after coming to a complete stop. Always stop the vehicle in a safe location before performing these functions. Failure to do so may result in an accident.

KEEP THE VOLUME AT A LEVEL WHERE YOU CAN STILL HEAR OUTSIDE NOISE WHILE DRIVING.

Failure to do so may result in an accident.

DO NOT DISASSEMBLE OR ALTER.

Doing so may result in an accident, fire or electric shock.

USE ONLY IN CARS WITH A 12 VOLT NEGATIVE GROUND.

(Check with your dealer if you are not sure.) Failure to do so may result in fire, etc.

KEEP SMALL OBJECTS SUCH AS BATTERIES OUT OF THE REACH OF CHILDREN.

Swallowing them may result in serious injury. If swallowed, consult a physician immediately.

USE THE CORRECT AMPERE RATING WHEN REPLACING FUSES.

Failure to do so may result in fire or electric shock.

DO NOT BLOCK VENTS OR RADIATOR PANELS.

Doing so may cause heat to build up inside and may result in fire.

USE THIS PRODUCT FOR MOBILE 12V APPLICATIONS.

Use for other than its designed application may result in fire, electric shock or other injury.

DO NOT PLACE HANDS, FINGERS OR FOREIGN OBJECTS IN INSERTION SLOTS OR GAPS.

Doing so may result in personal injury or damage to the product.



CAUTION

This symbol means important instructions. Failure to heed them can result in injury or material property damage.

HALT USE IMMEDIATELY IF A PROBLEM APPEARS.

Failure to do so may cause personal injury or damage to the product. Return it to your authorized Alpine dealer or the nearest Alpine Service Centre for repairing.

DO NOT MIX NEW BATTERIES WITH OLD BATTERIES. INSERT WITH THE CORRECT BATTERY POLARITY.

When inserting the batteries, be sure to observe proper polarity (+ and -) as instructed. Rupture or chemical leakage from the battery may cause fire or personal injury.

KEEP FINGERS AWAY WHILE THE MOTORIZED FRONT PANEL OR MOVING MONITOR IS IN MOTION.

Failure to do so may result in personal injury or damage to the product.



PRECAUTIONS

Product Cleaning

Use a soft dry cloth for periodic cleaning of the product. For more severe stains, please dampen the cloth with water only. Anything else has the chance of dissolving the paint or damaging the plastic.

Temperature

Be sure the temperature inside the vehicle is between +60°C (+140°F) and -10°C (+14°F) before turning your unit on.

Moisture Condensation

You may notice the CD playback sound wavering due to condensation. If this happens, remove the disc from the player and wait about an hour for the moisture to evaporate.

Damaged Disc

Do not attempt to play cracked, warped, or damaged discs. Playing a bad disc could severely damage the playback mechanism.

Maintenance

If you have problems, do not attempt to repair the unit yourself. Return it to your Alpine dealer or the nearest Alpine Service Station for servicing.

PRECAUTIONS

Never Attempt the Following

Do not grip or pull out the disc while it is being pulled back into the player by the automatic reloading mechanism.

Do not attempt to insert a disc into the unit when the unit power is off.

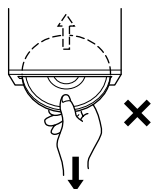

Inserting Discs

Your player accepts only one disc at a time for playback. Do not attempt to load more than one disc.

Make sure the label side is facing up when you insert the disc.

Your player will automatically eject any disc that is inserted incorrectly. If the player continues to eject a correctly inserted disc, push the RESET switch with a pointed object such as a ballpoint pen.

Playing a disc while driving on a very bumpy road may result in skips, but this will not scratch the disc or damage the player.

New Discs

As a protective measure to prevent the CD from jamming, the CD player will automatically eject discs with irregular surfaces or inserted incorrectly. When a new disc is inserted into the player and ejected after initial loading, using your finger, feel around the inside of the centre hole and outside edge of the disc. If you feel any small bumps or irregularities, this could inhibit proper loading of the disc. To remove the bumps, rub the inside edge of the hole and outside edge of the disc with a ballpoint pen or other such instrument, then insert the disc again.

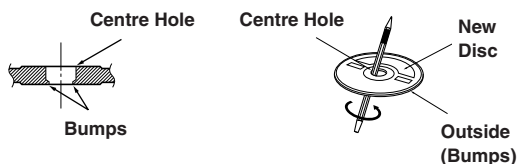

Irregular Shaped Discs

Be sure to use round shape discs only for this unit and never use any special shape discs.

Use of special shape discs may cause damage to the mechanism.

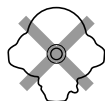

Installation Location

Make sure the CDA-9835R/CDA-9833R will not be installed in a location subjected to:

- Direct sun and heat
- High humidity and water
- Excessive dust
- Excessive vibrations

Correct Handling

Do not drop the disc while handling. Hold the disc so you will not leave fingerprints on the surface. Do not affix tape, paper, or gummed labels to the disc. Do not write on the disc.

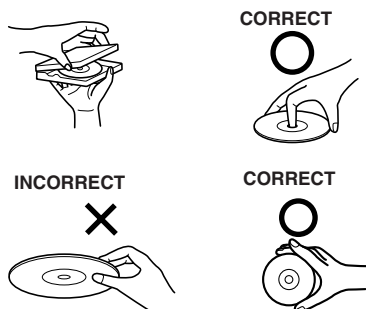

Disc Cleaning

Fingerprints, dust, or soil on the surface of the disc could cause the CD player to skip. For routine cleaning, wipe the playing surface with a clean, soft cloth from the centre of the disc to the outer edge. If the surface is heavily soiled, dampen a clean, soft cloth in a solution of mild neutral detergent before cleaning the disc.



Disc Accessories

There are various accessories available on the market for protecting the disc surface and improving sound quality. However, most of them will influence the thickness and/or diameter of the disc. Using such accessories can cause the disc to be out of standard specifications and may create operational problems. We recommend not using these accessories on discs played in Alpine CD players.

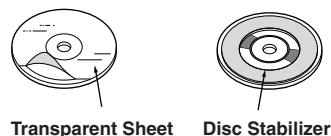

On handling Compact Discs (CD/CD-R/CD-RW)

- Do not touch the surface.
- Do not expose the disc to direct sunlight.
- Do not affix stickers or labels.
- Clean the disc when it is dusty.
- Make sure that there are no bumps around the disc.
- Do not use commercially available disc accessories.

Do not leave the disc in the car or the unit for a long time. Never expose the disc to direct sunlight. Heat and humidity may damage the CD and you may not be able to play it again.

To customers using CD-R/CD-RW

- If a CD-R/CD-RW cannot be played back, make sure the last recording session was closed (finalized).
- Finalize the CD-R/CD-RW if necessary, and attempt playback again.

About media that can be played.

Use only compact discs with the label side showing the CD logo marks below.



If you use unspecified compact discs, correct performance cannot be guaranteed.

You can play CD-Rs (CD-Recordable)/CD-RWs (CD-ReWritable) which have been recorded only on audio devices.

You can also play CD-Rs/CD-RWs containing MP3/WMA formatted audio files.

- Some of the following CDs may not play on this unit:
Flawed CDs, CDs with fingerprints, CDs exposed to extreme temperatures or sunlight (e.g., left in the car or this unit), CDs recorded under unstable conditions, CDs on which a recording failed or a re-recording was attempted, copy-protected CDs which do not conform to the audio CD industry standard.
- Use discs with MP3/WMA files written in a format compatible with this unit. For details, see pages 16-17.

Getting Started

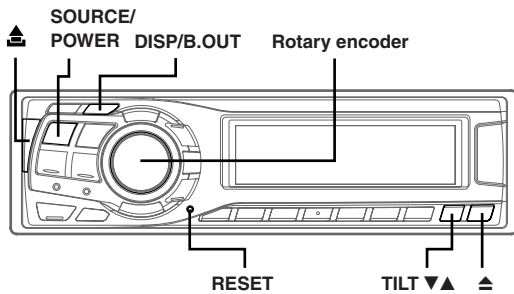

Turning Power On and Off

Press **SOURCE/POWER** to turn on the unit.

- The unit can be turned on by pressing any other button except eject ▲.

Press and hold **SOURCE/POWER** for at least 2 seconds to turn off the unit.

- The first time power is turned on, the volume will start from level 12.

Initial System Start-Up

Be sure to press the RESET switch when using the unit for the first time, after installing the CD changer, after changing the car battery, etc.

- 1 Turn off the unit power.
- 2 Press **RESET** with a ballpoint pen or similar pointed object.

Opening and Closing the Movable Display

Press ▲.
The movable display will open.

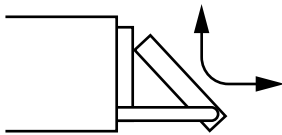

To close the movable display, press ▲ again.
The movable display will close.

- Do not apply shock to the movable display when it is open as it may result in malfunction of the unit.
- The display may be dim during low temperatures and immediately after turning on the power. The brightness will return to normal as time elapses.
- The display will stop at the set tilt angle when closing.

Caution

Keep hands (or any other object) away from the display while it is opening or closing to avoid damage or injury. The back of the movable display will get very warm under normal operating conditions. This is not a malfunction. Do not touch.

Display Tilt Adjustment

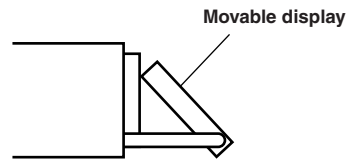

The movable display may be adjusted to 3 different tilt angles depending upon user preference.

Press **TILT ▼▲** to adjust the tilt angle of the movable display.

- The display will close a half minute after the ignition key is turned to the OFF position.
- The adjusted tilt angle of the display is stored in memory. There is no need to re-adjust the tilt angle when the power is turned back on.

Caution

Keep hands (or any other object) away from the display while it is opening or closing to avoid damage or injury. The back of the movable display will get very warm under normal operating conditions. This is not a malfunction. Do not touch.

Adjusting Volume

Turn the **Rotary encoder** until the desired sound is obtained.

Changing the Display Type (CDA-9833R only)

There are three selectable display types. You can also deactivate the display.

Press **DISP/B.OUT** to switch the display type.

TYPE1 → TYPE2 → TYPE3 → OFF → TYPE1

TYPE1 : The indicator on the left changes in a fixed sequence.

TYPE2 : The indicator on the left changes according to the setting (see "Setting the Multicolour Illumination" on page 27)

TYPE3 : The indicator on the left changes according to audio level.

Switching the Display modes (CDA-9835R only)

You can select the display pattern mode from three display patterns.

Press **DISP/B.OUT** to select the desired display pattern mode.

Each press changes the display patterns.

Basic display of each source → Animation display pattern1 → Animation display pattern2 → Basic display of each source

Detaching and Attaching the Front Panel

Detaching

- 1 Turn off the unit power.
- 2 Press  (Release) at the upper left side until the front panel pops out.
- 3 Grasp the left side of the front panel and pull it out.

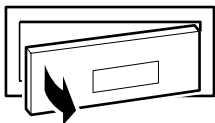

- The front panel may become hot in normal usage (especially the connector terminals on the back of the front panel.) This is not a malfunction.
- To protect the front panel, place it in the supplied carrying case.

Attaching

- 1 Insert the right side of the front panel into the main unit. Align the groove on the front panel with the projections on the main unit.
- 2 Push the left side of the front panel until it locks firmly into the main unit.

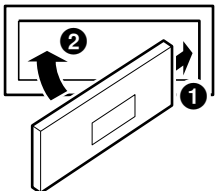

- Before attaching the front panel, make sure that there is no dirt or dust on the connector terminals and no foreign object between the front panel and the main unit.
- Attach the front panel carefully, holding the sides of the front panel to avoid pushing buttons by mistake.

Radio

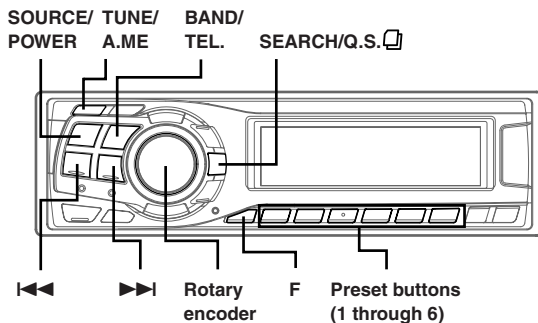

Listening to Radio

- 1 Press **SOURCE/POWER** until a radio frequency appears in the display.
- 2 Press **BAND/TEL.** repeatedly until the desired radio band is displayed.
FM1 → FM2 → FM3 → MW → LW → FM1
- 3 Press **TUNE/A.ME** to select the tuning mode.

CDA-9835R:

DX (Distance mode) → LOCAL (Local mode) →
MANUAL (Manual mode) → DX

CDA-9833R:

DX SEEK (Distance mode) → SEEK (Local mode) →
OFF (Manual mode) → DX SEEK

- The initial mode is Distance mode.

Distance mode:

Both strong and weak stations will be automatically tuned in (Automatic Seek Tuning).

Local mode:

Only strong stations will be automatically tuned in (Automatic Seek Tuning).

Manual mode:

The frequency is manually tuned in steps (Manual tuning).

- 4 Press **◀◀** or **▶▶** to tune in the desired station.
Holding down **◀◀** or **▶▶** will change the frequency continuously.

- The ST indicator appears on the display when a stereo FM station is tuned in.

Manual Storing of Station Presets

- 1 Select the radio band and tune in a desired radio station you wish to store in the preset memory.**
- 2 Press and hold, for at least 2 seconds, any one of the preset buttons (1 through 6) into which you wish to store the station.**

The selected station is stored.
The display shows the band, preset no. and station frequency memorized.

 - A total of 30 stations can be stored in the preset memory (6 stations for each band; FM1, FM2, FM3, MW and LW).
 - If you store a station in a preset memory which already has a station, the current station will be cleared and replaced with the new station.
 - If the function mode is activated (the "FUNC" indicator for the CDA-9833R model is lit), press **F** to return to normal mode.

Automatic Memory of Station Presets

- 1 Press BAND/TEL. repeatedly until the desired radio band is displayed.**
- 2 Press and hold TUNE/A.ME for at least 2 seconds.**

The frequency on the display continues to change while the automatic memory is in progress. The tuner will automatically seek and store 6 strong stations in the selected band. They will be stored into buttons 1 to 6 in order of signal strength.
When the automatic memory has been completed, the tuner goes to the station stored in preset location no. 1.

 - If no stations are stored, the tuner will return to the original station you were listening to before the auto memory procedure began.

Tuning to Preset Stations

- 1 Press BAND/TEL. repeatedly until the desired band is displayed.**
- 2 Press any one of the station preset buttons (1 through 6) that has your desired radio station in memory.**

The display shows the band, preset number and frequency of the station selected.

 - If the function mode is activated (the "FUNC" indicator for the CDA-9833R model is lit), press **F** to return to normal mode.

Station Title Search Function



If the title of a radio station is entered, you can search for that radio station by its title while listening to the currently received radio station.

- 1 Press SEARCH/Q.S.  in Radio mode to switch to Title Search mode.**

The first title input blinks in the display.
- 2 Select the desired title by turning the Rotary encoder within 10 seconds.**
- 3 Press the Rotary encoder to receive the frequency of the selected title.**
 - Search mode in Title Search mode is cancelled by pressing and holding **SEARCH/Q.S. ** for at least 2 seconds.
 - If a station has no title, "NO TITLE" is displayed for 2 seconds.
 - Any radio station can be searched by the Station Title Search function. The station titles are displayed in the order they were input.

Frequency Search Function

You can search for a radio station by its frequency.

- 1 Press and hold SEARCH/Q.S.  for at least 2 seconds in Radio mode to activate Frequency Search mode.**
- 2 Turn the Rotary encoder within 10 seconds to select the desired frequency.**
- 3 Press the Rotary encoder to receive the selected frequency.**
 - Search mode in Frequency Search mode is cancelled by pressing and holding **SEARCH/Q.S. ** for at least 2 seconds.

RDS

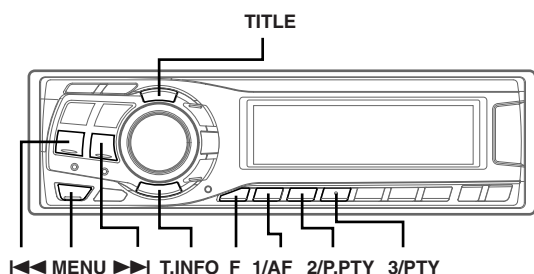

Setting RDS Reception Mode and Receiving RDS Stations

The RDS (Radio Data System) is a radio information system using the 57 kHz subcarrier of regular FM broadcast. The RDS allows you to receive a variety of information such as traffic information, station names, and to automatically re-tune to a stronger transmitter that is broadcasting the same programme.

- 1 Press **F** to activate function mode (for the CDA-9833R model, press **F** to illuminate the “FUNC” indicator).
- 2 Press **1/AF** to activate the RDS mode.
- 3 Press **◀** or **▶** to tune in the desired RDS station.
- 4 Press **1/AF** again to deactivate the RDS mode.
- 5 Press **F** to activate the normal mode (for the CDA-9833R model, the “FUNC” indicator goes out).

- When the unit receives the *PTY31* (Emergency Broadcast) signal, the unit will show “ALARM” in the display automatically.

The RDS digital data includes the following:

PI	Programme Identification
PS	Programme Service Name
AF	List of Alternative Frequencies
TP	Traffic Programme
TA	Traffic Announcement
PTY	Programme Type
EON	Enhanced Other Networks

Recalling Preset RDS Stations

- 1 Press **F** to activate function mode (for the CDA-9833R model, press **F** to illuminate the “FUNC” indicator).
- 2 Press **1/AF** to activate the RDS mode.
- 3 Press **F** to activate the normal mode (for the CDA-9833R model, the “FUNC” indicator goes out).
- 4 Make sure that the function mode returns to normal mode (the “FUNC” indicator for the CDA-9833R model goes out), then press the preset button in which your desired RDS station is preset. If the preset station’s signal is weak, the unit automatically searches and tunes to a stronger station in the AF (Alternative Frequencies) list.
- 5 If the preset station and the stations in the AF list cannot be received:

When the PI SEEK setting is on (refer to “PI SEEK Setting” page 10), the unit searches again for a station in the PI (Programme Identification) list.

If there are still no stations receivable in the area, the unit displays the frequency of the preset station and the preset no. disappears.

If the signal level of the Regional (Local) station being tuned becomes too weak to receive, press the same preset button to tune in a Regional station in other district.

- For presetting the RDS stations, refer to the Radio Operation section. The RDS stations can be preset in the FM1, FM2 and FM3 bands only.

Receiving RDS Regional (Local) Stations

- 1 Press **MENU** to select the SETUP mode.
- 2 Select the “RDS REGIONAL” mode by pressing **◀** or **▶**.
- 3 Choose either ON or OFF by turning the Rotary encoder. In the RDS REG OFF mode, the unit automatically keeps receiving the related local RDS station.
- 4 Press and hold **MENU** for at least 2 seconds to return to normal mode, or press **MENU** and select RETURN to return to normal mode.

PI SEEK Setting

- 1 Press **MENU** to select the SETUP mode.
- 2 Select the “PI SEEK” mode by pressing **◀◀** or **▶▶**.
- 3 Choose either **ON** or **OFF** by turning the **Rotary encoder**.
- 4 Press and hold **MENU** for at least 2 seconds to return to normal mode, or press **MENU** and select **RETURN** to return to normal mode.

Receiving Traffic Information

- 1 Press **T.INFO** so that the “T.INFO” indicator lights up.
- 2 Press **◀◀** or **▶▶** to select your desired traffic information station.

When a traffic information station is tuned in, the “TP” indicator lights up.

Traffic information is heard only when it is being broadcast. If traffic information is not being broadcast, the unit is set in the standby mode. When a traffic information broadcast begins, the unit automatically receives it and the display shows “TRF-INFO” for a few seconds and returns to the PS display.

When the traffic information broadcast is over, the unit will automatically set in the standby mode.

- If the traffic information broadcast signal falls below a certain level, the unit remains in the receiving mode for 70 seconds. If the signal remains below a certain level for over 70 seconds, the “T.INFO” indicator blinks.
- If you do not want to listen to the traffic information being received, lightly press **T.INFO** to skip that traffic information message. The **T.INFO** mode will remain in the **ON** position to receive the next traffic information message.
- If the volume level is changed while receiving traffic information, the changed volume level will be memorized. When traffic information is received next time, the volume level will be automatically adjusted to the level memorized.
- In the **T.INFO** mode, the **SEEK** tuning selects only the **TP** stations.

PTY (Programme Type) Tuning

- 1 Press **F** to activate function mode (for the **CDA-9833R** model, press **F** to illuminate the “**FUNC**” indicator).
- 2 Press **3/PTY** to activate the **PTY** mode, while the unit is in **Radio (FM receiving)** mode.

The Programme Type of the station being currently received will be displayed for 5 seconds.
 If there is no receivable **PTY** broadcast, “NO **PTY**” will be displayed for 5 seconds.
 If no **RDS** station can be received, the display shows “NO **PTY**.”

 - If no operation is performed within 5 seconds after pressing **3/PTY**, the **PTY** mode will be automatically cancelled.
- 3 Press **◀◀** and **▶▶** within 5 seconds after activating the **PTY** mode to choose the desired programme type while the **PTY (programme type)** is being displayed.

Each press scrolls the programme type by one.

```

r - - LIGHT M ↔ CLASSICS ↔ OTHER M - - r
└ - - - - - - - - - - - - - - - - - - - - ┘
      
```
- 4 Press **3/PTY** within 5 seconds after selecting the programme type to start searching for a station in the selected programme type.

The chosen programme type display blinks during searching and lights when a station is found.

If no **PTY** station is found, “NO **PTY**” will be displayed for 5 seconds.
- 5 Press **F** to activate the normal mode (for the **CDA-9833R** model, the “**FUNC**” indicator goes out).
 - When the function mode is activated (the “**FUNC**” indicator for the **CDA-9833R** model is lit), perform the operation. The function mode returns to normal mode if no operation is performed within 5 seconds for the **CDA-9833R** model.

Receiving Traffic Information While Playing CD or Radio

- 1 Press T.INFO** so that the "T.INFO" indicator lights up.
- 2 Press ◀◀ and ▶▶** to select a traffic information station if necessary.

When a traffic information broadcast starts, the unit automatically mutes the CD player/changer or the regular FM broadcast.

When the traffic information broadcast finishes, the unit automatically returns to the original source play before the traffic information broadcast began.

When traffic information stations cannot be received:

In the tuner mode:

When the TP signal can no longer be received for over 70 seconds, the "T.INFO" indicator blinks.

In the CD mode:

When the TP signal can no longer be received, the traffic information station of another frequency will be selected automatically.

- *The receiver is equipped with the EON (Enhanced Other Networks) function in order to keep track of additional alternate frequencies to the AF list. The "EON" indicator lights up while an RDS EON station is being received. If the station being received does not broadcast the traffic information, the receiver automatically tunes in the related station that broadcasts the traffic information when it occurs.*

- 3 Press T.INFO** to deactivate the Traffic Information mode.

The "T.INFO" indicator goes out.

Priority PTY (Programme Type)

This function allows presetting of a programme type such as music category, news, etc. You can listen to a programme in the preset programme type as the unit automatically gives priority to the preset programme type when it begins broadcasting, and interrupts the programme you are currently listening. This feature is functional when your unit is set to a mode other than the LW and MW.

- 1 Press F** to activate function mode (for the CDA-9833R model, press F to illuminate the "FUNC" indicator).

- 2 Press 2/P.PTY** to activate the PRIORITY PTY mode.

"PRIO-PTY" is displayed for 2 seconds and then the programme type for 3 seconds. The initial setting is "NEWS."

- *If no operation is performed within 5 seconds after pressing 2/P.PTY, the PRIORITY PTY mode is automatically cancelled.*

- 3 Press ◀◀ or ▶▶** within 5 seconds while "NEWS" is being displayed to choose a desired programme type. Then press 2/P.PTY.

The PRIORITY PTY function will activate.

- 4 Press 2/P.PTY** to activate the PRIORITY PTY mode again.

To change the programme category, perform the step 3. To disable the PRIORITY PTY function, press and hold 2/P.PTY for at least 2 seconds.

- *In the PRIORITY PTY function, unlike in the T.INFO function, the volume does not increase during operation.*

- 5 Press F** to activate the normal mode (for the CDA-9833R model, the "FUNC" indicator goes out).

- *When the function mode is activated (the "FUNC" indicator for the CDA-9833R model is lit), perform the operation. The function mode returns to normal mode if no operation is performed within 5 seconds for the CDA-9833R model.*

Displaying Radio Text

Text messages from a radio station can be displayed.

Press **TITLE** while receiving FM in the radio mode to select the Radio Text display.

The display will change every time the button is pressed.

CDA-9835R^{*1}

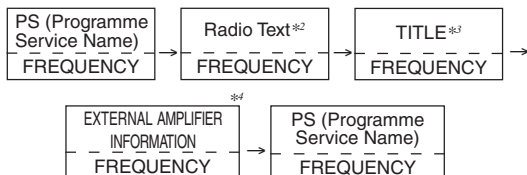

CDA-9833R

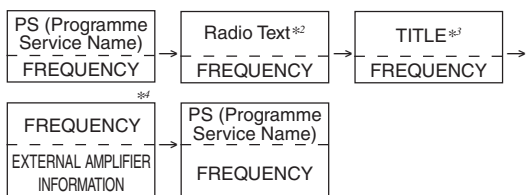

The display shows "WAITING" for a few seconds, then starts scrolling the text message.

^{*1} The display example for the normal display mode is described. The display changes depending on the display indication pattern. (See "Switching the Display modes" on page 6)

^{*2} If there is no receivable text message or the unit cannot receive a text message properly, the display shows "NO TEXT."

^{*3} TITLE can be input or erased.

^{*4} Only when an external Amplifier Link compatible amplifier is connected. For details, refer to "Displaying the External Amplifier Information" (page 26).

CD/MP3/WMA

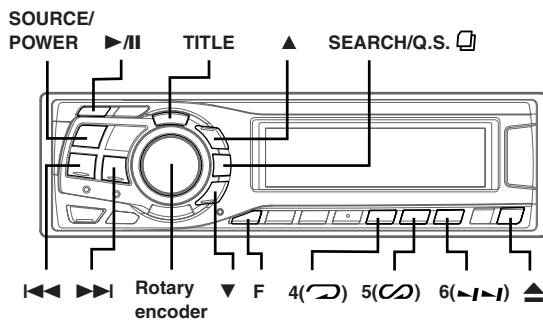

Playback

- 1 Press **▲**.
The movable display will open.
- 2 Insert a disc with the label side facing up.
The disc will be pulled into the unit automatically.

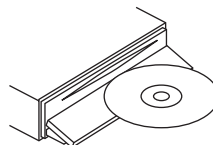

The movable display will close and playback will begin. When a disc is already inserted, press SOURCE/POWER to switch to the CD mode.

The mode will change every time the button is pressed.

TUNER → CD → CD CHANGER* → TUNER

* Only when the CD changer is connected

- 3 While playing back MP3/WMA, press **▲** or **▼** to select the desired folder.
Pressing and holding **▲** or **▼** will change folders continuously.
- 4 Press **◀◀** or **▶▶** to select the desired track (file).
Returning to the beginning of the current track (file):
Press **◀◀**.
Fast backward :
Press and hold **◀◀**.
Advancing to the beginning of the next track (file) :
Press **▶▶**.
Fast forward :
Press and hold **▶▶**.
- 5 To pause playback, press **▶||**.
Pressing **▶||** again will resume playback.
- 6 To eject the disc, press **▲**.

- Do not remove a CD during its eject cycle. Do not load more than one disc at a time. A malfunction may result from doing either.
- If the CD does not eject, press and hold **▲** for at least 2 seconds with the movable display open.

- The CD-player can play discs containing audio data, MP3 data and WMA data.
- A WMA format file that is protected by DRM (Digital Rights Management) cannot be played back on this unit.
- “MP3” is displayed during MP3 playback.
- “WMA” is displayed during WMA playback.
- The track display for MP3/WMA data playback is the file numbers recorded on the disc.
- If the HDA-5460 model is connected to the unit, some operations (for example changing the source, selecting the file by holding buttons up or down, etc.), can be carried out on this unit.

MP3/WMA Play Display

CDA-9835R

The folder number and file number will be displayed as described below.

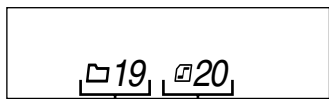

Folder number display File number display

CDA-9833R

The folder number, file number, sampling rate, and bit rate will be displayed as described below.

Folder number display

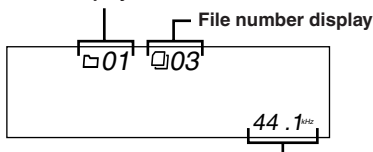

Sampling rate display



The sampling rate and the bit rate (frame display) are alternately displayed.*

Folder number display

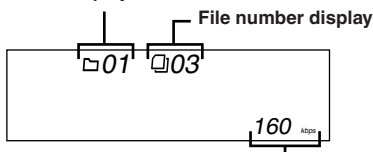

Bit rate display

*When the unit is connected to the Amplifier Link, the temperature is automatically indicated.

Sampling rate → Bit rate → Temperature → Sampling rate

- Press **TITLE** to switch the display. Please see “Displaying the Title/Text” (page 23) for information about display switching.

Playing back a Playlist

You can play playlists you have prepared in advance on the computer. Both MP3 and WMA playlists can be played.

Playlists that can be played back by this device have the file extension “m3u”/“asx.”

Press ▲ or ▼ to select a playlist.

By pressing and holding ▲ or ▼, the playlists move up or down continuously.

- If there is a playlist and folder on the disc, the playlist starts to play back prior to the folder.
- Up to 5 playlist can be played back. Playlists from the 6th onwards cannot be played back.
- Refer to the software instruction manual on how to create a playlist.

Playlist Display

While playing back a playlist, the folder and file numbers that are stored in the playlist are displayed.

CDA-9835R

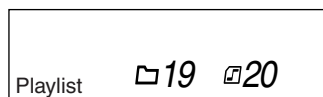

CDA-9833R

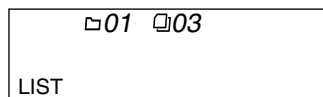

Repeat Play

Press **4** (↶) to play back repeatedly the track being played.

The track (file) will be played repeatedly.

Press **4** (↶) again and select OFF to deactivate repeat play.

CD mode :

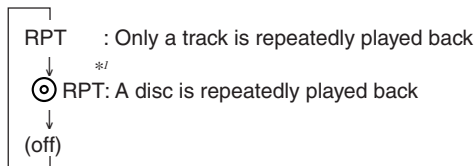

*1 When a CD changer is connected.

- If REPEAT is set to ON during M.I.X. play in CD changer mode, M.I.X. will apply to the current disc only.

MP3/WMA mode :

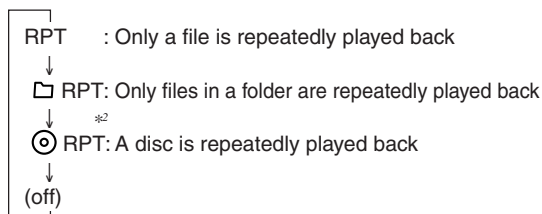

*2 When an MP3 compatible CD changer is connected.

- If a 6-disc CD changer or an MP3 compatible CD changer is connected:
In the CD changer mode (for the CDA-9835R model), press **F** to display the M.I.X./REPEAT/SCAN function guide where the preset buttons (1 to 6) are explained, and go to the step above. When no buttons are pressed, the guide disappears after 10 seconds but the mode remains active.
In the CD changer mode (for the CDA-9833R model), press **F** to illuminate the "FUNC" indicator, and go to the step above within 5 seconds.
- If a 12-disc CD changer is connected:
In the CD changer mode (for the CDA-9835R model), press **F** to display the M.I.X./REPEAT/SCAN function guide where the preset buttons (1 to 6) are explained, and go to the step above. When no buttons are pressed, the guide disappears after 10 seconds but the mode remains active.
In the CD changer mode (for the CDA-9833R model), press **F** twice to illuminate the "FUNC" indicator, and go to the step above within 5 seconds.

M.I.X. (Random Play)

Press **5** (⌂) in the play or pause mode.

The tracks (files) on the disc will be played back in random sequence.

To cancel M.I.X. play, press **5** (⌂) again.

CD mode :

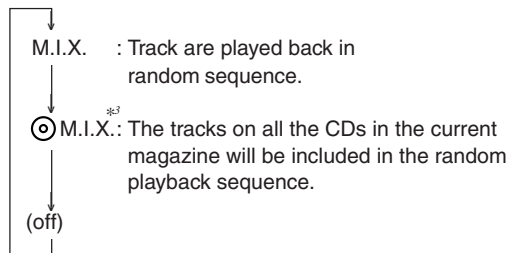

*3 When a CD changer equipped with the All M.I.X. function is connected.

- If M.I.X. is set to ON during (⊙) RPT (REPEAT ALL) play in CD changer mode, M.I.X. will apply to the current disc only.

MP3/WMA mode :

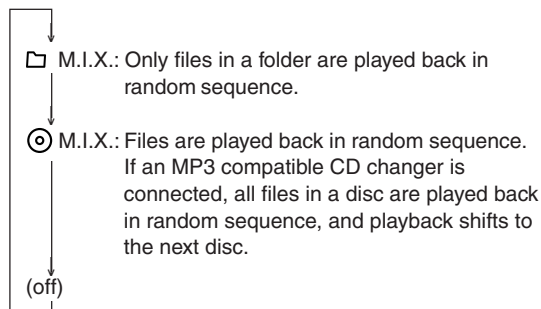

- If a 6-disc CD changer or an MP3 compatible CD changer is connected:
In the CD changer mode (for the CDA-9835R model), press **F** to display the M.I.X./REPEAT/SCAN function guide where the preset buttons (1 to 6) are explained, and go to the step above. When no buttons are pressed, the guide disappears after 10 seconds but the mode remains active.
In the CD changer mode (for the CDA-9833R model), press **F** to illuminate the "FUNC" indicator, and go to the step above within 5 seconds.
- If a 12-disc CD changer is connected:
In the CD changer mode (for the CDA-9835R model), press **F** to display the M.I.X./REPEAT/SCAN function guide where the preset buttons (1 to 6) are explained, and go to the step above. When no buttons are pressed, the guide disappears after 10 seconds but the mode remains active.
In the CD changer mode (for the CDA-9833R model), press **F** twice to illuminate the "FUNC" indicator, and go to the step above within 5 seconds.
- When playing back a playlist, M.I.X. cannot be played.

Scanning Programmes

Press **6** (↵) to activate the Scan mode.



The first 10 seconds of each track (file) will be played back in succession.

To stop scanning, press **6** (↵) and deactivate the Scan mode.

- If a 6-disc CD changer or an MP3 compatible CD changer is connected:
In the CD changer mode (for the CDA-9835R model), press **F** to display the M.I.X./REPEAT/SCAN function guide where the preset buttons (1 to 6) are explained, and go to the step above. When no buttons (1 to 6) are pressed, the guide disappears after 10 seconds but the mode remains active.
In the CD changer mode (for the CDA-9833R model), press **F** to illuminate the "FUNC" indicator, and go to the step above within 5 seconds.
- If a 12-disc CD changer is connected:
In the CD changer mode (for the CDA-9835R model), press **F** to display the M.I.X./REPEAT/SCAN function guide where the preset buttons (1 to 6) are explained, and go to the step above. When no buttons are pressed, the guide disappears after 10 seconds but the mode remains active.
In the CD changer mode (for the CDA-9833R model), press **F** twice to illuminate the "FUNC" indicator, and go to the step above within 5 seconds.

Searching from CD Text

Tracks can be searched and played using the CD text on the disc. In the case of discs and changers that do not support text, searches can be made using the track numbers.

- 1 Press SEARCH/Q.S.**  during play.
This will set the search mode.
 - 2 Turn the Rotary encoder to select the desired track, then press the Rotary encoder.**
This will play the selected track.
- Press and hold **SEARCH/Q.S.**  for at least 2 seconds in the search mode to cancel. Or, the search mode will be cancelled when an operation has not been performed in 10 seconds.
 - CD text search cannot be made during M.I.X. play.



File/Folder Name Search (concerning MP3/WMA)

You can display and search for the folder and file name while listening to the file currently being played back.

- 1 Press SEARCH/Q.S.**  to select File Name Search mode or Folder Name Search mode in MP3/WMA mode.



File Name Search mode

- 2 Press ▲ or ▼** to select another Folder or playlist.
- 3 Select the desired file by turning the Rotary encoder within 10 seconds.**
- 4 Press the Rotary encoder to play back the selected file.**

- File Name Search mode is cancelled by pressing and holding **SEARCH/Q.S.**  for at least 2 seconds.
- While in File Name Search mode, press **SEARCH/Q.S.**  to switch to Folder Name Search mode.
- File Name search cannot be made during M.I.X. play.
- File Name search cannot be made while playing back a playlist.



Folder Name Search mode

- 2 Turn the Rotary encoder within 10 seconds to select the desired folder or playlist.**
- 3 Press the Rotary encoder to play back the first file in the selected folder or playlist.**

- Search mode is cancelled by pressing and holding **SEARCH/Q.S.**  for at least 2 seconds in Folder Name Search mode.
- While in Folder Name Search mode, press **SEARCH/Q.S.**  to switch to File Name Search mode.
- "NO FILE" is displayed for 2 seconds if the folder or playlist that is selected by the Folder Name Search mode contains no files.
- "0 (zero)" is displayed for the root folder.
- Folder Name search cannot be made during M.I.X. play.

Quick Search

You can search for tracks (files).

- 1 Press and hold SEARCH/Q.S.**  for at least 2 seconds in the CD/Changer/MP3/WMA mode to activate Quick Search mode.
 - 2 Turn the Rotary encoder within 10 seconds to select a desired track (file).**
The selected track is played back immediately.
- Search mode is cancelled by pressing and holding **SEARCH/Q.S.**  for at least 2 seconds in Quick Search mode.

About MP3/WMA

CAUTION

Except for private use, duplicating audio data (including MP3/WMA data) or distributing, transferring, or copying it, whether for free or for a fee, without permission of the copyright holder is strictly prohibited by the Copyright Act and by international treaty.

What is MP3?

MP3, whose official name is "MPEG-1 Audio Layer 3," is a compression standard prescribed by the ISO, the International Standardization Organization and MPEG which is a joint activity institution of the IEC.

MP3 files contain compressed audio data. MP3 encoding is capable of compressing audio data at extremely high ratios, reducing the size of music files to as much as one-tenth their original size. This is achieved while still maintaining near CD quality. The MP3 format realizes such high compression ratios by eliminating the sounds that are either inaudible to the human ear or masked by other sounds.

What is WMA?

WMA, or "Windows Media™ Audio," is compressed audio data.

WMA allows you to create music files and store them at higher ratios of compression than MP3 audio data (approx. half original size). This is achieved while still maintaining CD quality sound.

Method for creating MP3/WMA files

Audio data is compressed by using MP3/WMA specified software. For details on creating MP3/WMA files, refer to the user's manual for that software. MP3/WMA files that can be played back by this device have the file extension "mp3" / "wma". Files with no extension cannot be played back. (WMA ver. 7.1 and 8 are supported)

Supported playback sampling rates and bit rates

MP3

Sampling rates: 48 kHz, 44.1 kHz, 32 kHz, 24 kHz, 22.05 kHz,
16 kHz, 12 kHz, 11.025 kHz, 8 kHz

Bit rates: 8 - 320 kbps

WMA

Sampling rates: 48 kHz, 44.1 kHz, 32 kHz, 24 kHz,
22.05 kHz

Bit rates: 48 - 192 kbps

Note that for sampling rates, this device's frame display (Pages 23 to 24) may not display correctly.

This device may not play back correctly depending on sampling rates.

ID3 tags/WMA tags

This device supports ID3 tag v1 and v2, and WMA tag. If tag data is in an MP3/WMA file, this device can display the title (track title), artist name, and album name ID3 tag/WMA tag data.

This device can only display single-byte alphanumeric characters (up to 30 for ID3 tags and up to 15 for WMA tags) and the underscore. For non-supported characters, "NO SUPPORT" is displayed.

The tag information may not be correctly displayed, depending on the contents.

Producing MP3/WMA discs

MP3/WMA files are prepared, then written to a CD-R or CD-RW using CD-R writing software. A disc can hold up to 999 files/256 folders (including Root Folders).

Media supported

The media that this device can play back are CD-ROMs, CD-Rs, and CD-RWs.

Corresponding File Systems

This device supports discs formatted with ISO9660 Level 1 or Level 2.

Under the ISO9660 standard, there are some restrictions to remember.

The maximum nested folder depth is 8 (including the root directory). File/folder names are limited to 30 characters (including the extension).

Valid characters for folder/file names are letters A-Z (all caps), numbers 0-9, and '_' (underscore).

This device also can play back discs in Joliet, Romeo, etc., and other standards that conform to ISO9660. However, sometimes the file names, folder names, etc., are not displayed correctly.

Formats supported

This device supports CD-ROM XA, Mixed Mode CD, Enhanced CD (CD-Extra) and Multi-Session.

This device cannot correctly play back discs recorded with Track At Once or packet writing.

Order of files

The unit plays the files in the order that the writing software writes them. Therefore, the playing order may not be the same as the order you input. The playback order of the folders and files is as follows. However, the folder and file playback order differs from the folder no. and file no. indicated on the display.

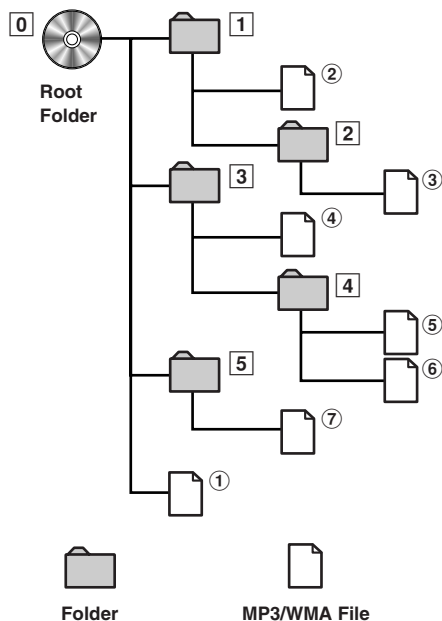

Terminology

Bit rate

This is the "sound" compression rate specified for encoding. The higher the bit rate, the higher the sound quality, but also the larger the files.

Sampling rate

This value shows how many times per second the data is sampled (recorded). For example, music CDs use a sampling rate of 44.1 kHz, so the sound is sampled (recorded) 44,100 times per second. The higher the sampling rate, the higher the sound quality, but also the larger the volume of data.

Encoding

Converting music CDs, WAVE (AIFF) files, and other sound files into the specified audio compression format.

Tag

Song information such as track titles, artist names, album names, etc., written into MP3/WMA files.

MP3: ID3 tag

WMA: WMA tag

Root folder

The root folder is found at the top of the file system. The root folder contains all folders and files.

Sound Setting

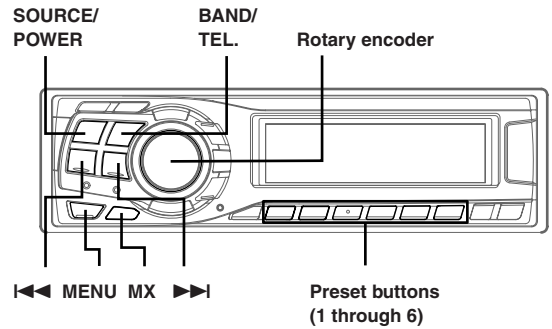

Adjusting Balance (Between Left and Right)/Fader (Between Front and Rear)/Defeat

1 Press the **Rotary encoder** repeatedly to choose the desired mode.

Each press changes the modes as follows:

SUBWOOFER*¹ → BALANCE → FADER → DEFEAT → VOLUME → SUBWOOFER*¹

Subwoofer : 0 ~ +15

Balance : L15 ~ R15

Fader : R15 ~ F15

Defeat : ON/OFF

Volume : 0 ~ 35

Press **◀◀** or **▶▶** after selecting the Subwoofer mode, and the subwoofer output phase is toggled NORMAL (PHASE 0°) or REVERS (PHASE 180°).

- If the **Rotary encoder** is not pressed within 5 seconds after selecting the **BALANCE**, **FADER**, **DEFEAT** or **SUBWOOFER** mode, the unit automatically returns to normal mode.
- If you set the 2WAY/3WAY switch (pages 40 to 42) to 3WAY, you cannot adjust the **FADER** mode.

*¹ When the subwoofer mode is set to OFF, its level and phase cannot be adjusted.

2 Turn the **Rotary encoder** until the desired sound is obtained in each mode.

By setting Defeat ON, previously adjusted settings of EQ will return to the factory defaults and MX is turned off.

- Depending on the connected devices, some functions and display indications do not work.

Equalizer Presets

3 typical equalizer settings are preset at the factory for a variety of musical source material.

1 Press MENU to select Factory's EQ.

2 Press either ◀◀ or ▶▶.

With each press of the button, the equalizer mode will display the selected equalizer characteristic.

FLAT(OFF) ↔ ROCK ↔ POPS ↔ NEWS ↔ USER'S 1 to 6
↔ FLAT(OFF)

FLAT (OFF) : Flat frequency

ROCK : Emphasize lows and highs

POPS : Emphasize midrange

NEWS : Boost midrange and suppress highs and lows

USER'S 1 to 6 : Recall the stored preset number in "Adjusting and Storing the Equalizer Curve."

3 Press and hold MENU for at least 2 seconds to return to normal mode, or press MENU and select RETURN to return to normal mode.

- This function is inoperable when DEFEAT is set to ON (page 17).
- EQ mode is automatically cancelled if no buttons are pressed within 15 seconds.

Adjusting and Storing the Equalizer Curve

You can modify the Equalizer settings to create a response curve more appealing to your personal taste.

1 Press and hold MENU for at least 2 seconds.

2 Press MENU to select USER EQ (USER'S EQ for CDA-9833R).

3 Press BAND/TEL. to select your desired frequency band.

BAND1 → BAND2 → BAND3 → BAND4 → BAND5 → BAND1

4 Press ◀◀ or ▶▶ to select your desired frequency.

Adjustable frequency bands:

20Hz to 20kHz (in 1/3 octave steps)

5 Turn the Rotary encoder to adjust the level.

6 Press SOURCE/POWER to select your desired band width (Q).

Adjustable band width: 1.0, 1.5, 3.0.

To store the adjusted curve

1) Press and hold, for at least 2 seconds, any one of the preset buttons (1 through 6) into which you wish to store the adjusted curve.

7 To set another channel, repeat steps 3 to 6.

8 Press the Rotary encoder to confirm the adjusted contents.

The adjusted contents are not stored if the Rotary encoder is not pressed.

9 After setting, press and hold MENU for at least 2 seconds to return to normal mode, or press MENU and select RETURN to return to normal mode.

- The frequencies of adjacent bands cannot be adjusted within 4 steps.
- EQ mode is automatically cancelled if no buttons are pressed within 15 seconds.
- This function is inoperable when DEFEAT is set to ON (page 17).

Recalling the Stored Equalizer Curve

1 Press and hold MENU for at least 2 seconds.

2 Press MENU to select USER EQ (USER'S EQ for CDA-9833R).

3 Press any one of the preset buttons (1 through 6) to activate your desired curve.

4 Press and hold MENU for at least 2 seconds to return to normal mode, or press MENU and select RETURN to return to normal mode.

- EQ mode is automatically cancelled if no operation is performed within 15 seconds.
- This function is inoperable when DEFEAT is set to ON (page 17).
- You can recall the adjusted equalizer curve from "Equalizer Presets" (this page).

About the Crossover

Crossover:

This unit is equipped with an active crossover. The crossover limits the frequencies delivered to the outputs. Each channel is controlled independently. Thus, each speaker pair can be driven by the frequencies for which they have been optimally designed. The crossover adjusts the HPF (high pass filter) or LPF (low pass filter) of each band, and also the slope (how fast the filter rolls off the highs or lows). Adjustments should be made according to the reproduction characteristics of the speakers. Depending on the speakers, a passive network may not be necessary. If you are unsure about this point, please consult your authorized Alpine dealer.

2 way mode

	Cut-off frequency (1/3 octave steps)		Slope		Level
	HPF	LPF	HPF	LPF	
Low range speaker	---	20 Hz - 200 Hz	---	FLAT, 6, 12, 18, 24 dB/oct	0 to -12 dB
Rear high range speaker	20 Hz - 200 Hz	---	FLAT, 6, 12, 18, 24 dB/oct	---	0 to -12 dB
Front high range speaker	20 Hz - 200 Hz	---	FLAT, 6, 12, 18, 24 dB/oct	---	0 to -12 dB

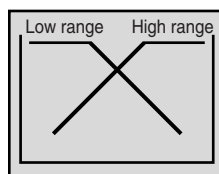

(Different from actual display)

3 way mode

	Cut-off frequency (1/3 octave steps)		Slope		Level
	HPF	LPF	HPF	LPF	
Low range speaker	----	20 Hz - 200 Hz	----	FLAT, 6, 12, 18, 24 dB/oct	0 to -12 dB
Mid range speaker	20 Hz - 200 Hz	20 Hz - 20 kHz	FLAT, 6, 12, 18, 24 dB/oct	FLAT, 6, 12, 18, 24 dB/oct	0 to -12 dB
High range speaker	1 kHz - 20 kHz	----	FLAT*1 6, 12, 18, 24 dB/oct	----	0 to -12 dB

*1 Only when selecting USER'S in "Setting the Response Slope for the High Range Speaker (TW SETUP)" (page 29).

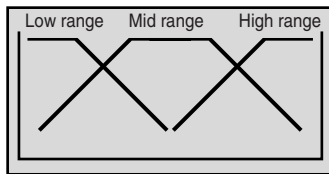

(Different from actual display)

Level adjusting (0 to -12 dB)

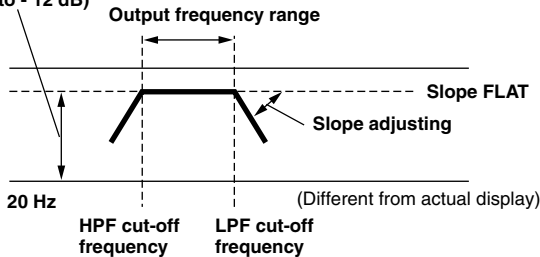

(Different from actual display)

- **HPF (high pass filter):** Cuts the lower frequencies and allows the higher frequencies to pass.
- **LPF (low pass filter):** Cuts the higher frequencies and allows the lower frequencies to pass.
- **Slope:** The level change (in dB) for a frequency change of one octave.
- The higher the slope value, the steeper the slope becomes.
- Adjust the slope to FLAT to bypass the HP or LP filters.
- Do not use a tweeter without the HPF on or set to a low frequency, as it may cause damage to the speaker due to the low frequency content.
- You cannot adjust the crossover frequency higher than the HPF or lower than the LPF.
- Adjustment should be made according to the recommended crossover frequency of the connected speakers. Determine the recommended crossover frequency of the speakers. Adjusting to a frequency range outside that recommended may cause damage to the speakers.
For the recommended crossover frequencies of Alpine speakers, refer to the respective Owner's Manual.
We are not responsible for damage or malfunction of speakers caused by using the crossover outside the recommended value.

Adjusting and Storing the Crossover Settings

Before performing the following procedures, refer to "About the Crossover" (Page 18).

- 1 Press and hold **MENU** for at least 2 seconds.
- 2 Press **MENU** to select X-OVER.

2 WAY System

- 3 Press **BAND/TEL.** to select desired parameter.

LOW (LO) → MID → HIGH → LOW (LO)
(Subwoofer) (REAR) (FRONT) (Subwoofer)

- 4 Press **◀◀** or **▶▶** to select desired cut-off frequency point (crossover point).

Adjustable frequency bands: 20 Hz to 200 Hz (in 1/3 octave steps)

- 5 Press **SOURCE/POWER** to select desired slope.

Adjustable slope: 0 (FLAT (OFF)), 1 (6 dB/oct.),
2 (12 dB/oct.), 3 (18 dB/oct.),
4 (24 dB/oct.)

- 6 Turn the **Rotary encoder** to select the desired output level.

Adjustable output level: -12 to 0 dB.

To store the adjusted contents

- 1) Press and hold, for at least 2 seconds, any one of the preset buttons (1 through 6) into which you wish to store the adjusted contents.

- 7 For setting another channel, repeat the steps 3 to 6.

- 8 Press the **Rotary encoder** to confirm the adjusted contents.

The adjusted contents are not stored if the Rotary encoder is not pressed.

- 9 After setting, press and hold **MENU** for at least 2 seconds to return to normal mode, or press **MENU** and select **RETURN** to return to normal mode.

- Crossover mode is automatically cancelled if no operation is performed within 15 seconds.

3 WAY System

- 3 Press **BAND/TEL.** to select desired parameter.

LOW (LO) → MID-L → MID-H → HIGH → LOW (LO)

- 4 Press **◀◀** or **▶▶** to select desired cut-off frequency point (crossover point).

Adjustable frequency bands:

LOW : 20 Hz to 200 Hz (in 1/3 octave steps)
MID-L : 20 Hz to 200 Hz (in 1/3 octave steps)
MID-H : 20 Hz to 20 kHz (in 1/3 octave steps)
HIGH : 1 kHz to 20 kHz (in 1/3 octave steps)

Continued

5 Press **SOURCE/POWER** to select the desired slope.

Adjustable slope: 0 (FLAT (OFF))*; 1 (6 dB/oct.),
2 (12 dB/oct.), 3 (18 dB/oct.),
4 (24 dB/oct.)

- * FLAT can be set for the HIGH slope only when USER'S is selected in "Setting the Response Slope for the High Range Speaker (TW SETUP)" (page 29). Depending on the response characteristics of the speaker, care should be taken when setting the response slope to FLAT, as speaker damage may result. A message is displayed when the response slope for the high range speaker is set to FLAT.

6 Turn the **Rotary encoder** to select the desired output level.

Adjustable output level: -12 to 0 dB.

To store the adjusted contents

- 1) Press and hold, for at least 2 seconds, any one of the preset buttons (1 through 6) into which you wish to store the adjusted contents.

7 For setting another channel, repeat the steps 3 to 6.

8 Press the **Rotary encoder** to confirm the adjusted contents.

The adjusted contents are not stored if the Rotary encoder is not pressed.

9 After setting, press and hold **MENU** for at least 2 seconds to return to normal mode, or press **MENU** and select **RETURN** to return to normal mode.

• About the 2way/3way system

You can switch to 2way/3way system mode with the 2way/3way switch on the bottom side of the unit (pages 40 to 42).

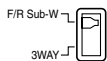

When setting to "3 WAY":

The unit can be operated in a 3 way system.

When setting to "F/R/Sub-W":

The unit can be operated in a 2 way system.

- Crossover mode is automatically cancelled if no operation is performed within 15 seconds.

Recalling the Stored Crossover Settings

1 Press and hold **MENU** for at least 2 seconds.

2 Press **MENU** to select X-OVER.

3 Press any one of the **preset buttons (1 through 6)** that has your desired crossover settings in memory.

4 Press and hold **MENU** for at least 2 seconds to return to normal mode, or press **MENU** and select **RETURN** to return to normal mode.

- Crossover mode is automatically cancelled if no operation is performed within 15 seconds.

About Time Correction

The distance between the listener and the speakers in a car vary widely due to the complex speaker placement. This difference in the distances from the speakers to the listener creates a shift in the sounds image and frequency characteristics. This is caused by the time delay between the sound reaching the listener's right versus the left ear. To correct this, the CDA-9835R/CDA-9833R is able to delay the audio signal to the speakers closest to the listener. This effectively creates a perception of increased distance for those speakers. The listener can be placed at an equal distance between the left and right speakers for optimum staging.

The adjustment will be made for each speaker in 0.1 ms steps.

Example 1. Listening Position: Front Left Seat

Adjust the time correction level of the front left speaker to a high value and the rear right to zero or a low value.

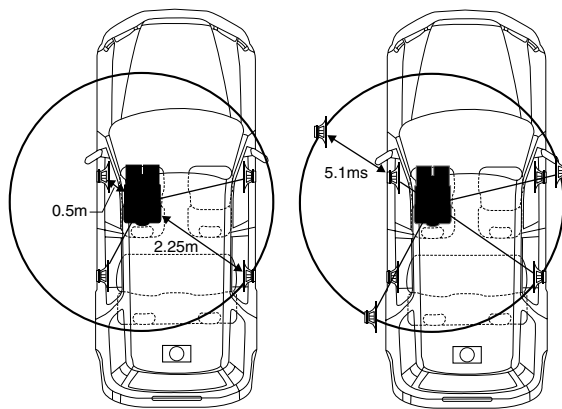

The sound is not balanced because the distance between the listening position and the various speakers is different. The difference in distance between the front left speaker and the rear right speaker is 1.75 m (68-7/8").

Here we calculate the time correction value for the front left speaker in the diagram on the above.

Conditions:

Farthest Speaker – listening position : 2.25 m (88-9/16")

Front left speaker – listening position : 0.5 m (19-11/16")

Calculation: $L = 2.25 \text{ m} - 0.5 \text{ m} = 1.75 \text{ m} (68-7/8")$

Time correction = $1.75 \div 343^{*j} \times 1000 = 5.1 \text{ (ms)}$

**j Speed of sound: 343 m/s (765 mph) at 20°C*

In other words, giving the front left speaker a time correction value of 5.1 ms makes it seem as if its distance from the listener is the same as the distance to the farthest speaker.

Time correction eliminates the differences in the time required for the sound to reach the listening position.

The time of the front left speaker is corrected by 5.1 ms so that its sound reaches the listening position at the same time as the sound of other speakers.

Example 2. Listening Position: All Seats

Adjust the time correction level of each speaker to almost the same level.

- 1 Sit in the listening position (driver's seat, etc.) and measure the distance (in meters) between your head and the various speakers.
- 2 Calculate the difference between the distance to the farthest speaker and the other speakers.
 $L = (\text{distance to farthest speaker}) - (\text{distance to other speakers})$
- 3 Divide the distances calculated for the speakers by the speed of sound (343 m/s (765 mph) at 20°C).
 These values are the time correction values for the different speakers.

Bass Focus

The time difference between the front-rear/left-right speakers, can be adjusted at the same time. With an initial delay of 0.1 ms for each of the 0 to 99 steps, audible time correction can be done.

- 1 Press and hold **MENU** for at least 2 seconds.
- 2 Press **MENU** to select Bass Focus mode or Time Correction mode.
- 3 Press **◀◀** or **▶▶** to select the Bass Focus mode.
 Bass Focus mode ↔ Time Correction mode
- 4 Press **BAND/TEL.** to select the speakers to be adjusted (see below).

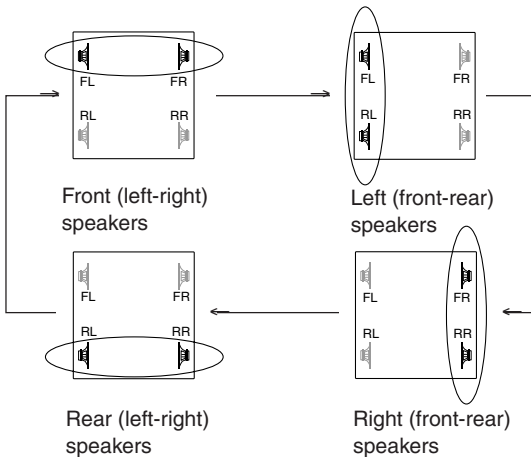

- 5 Turn the **Rotary encoder** to adjust the delay (see Time Difference Table, page 22).
- 6 To set another channel (speakers), repeat steps 4 and 5.

- 7 Press the **Rotary encoder** to confirm the adjusted contents.
 The adjusted contents are not stored if the Rotary encoder is not pressed.
- 8 After setting, press and hold **MENU** for at least 2 seconds to return to normal mode, or press **MENU** and select **RETURN** to return to normal mode.

- Any manual time correction adjustments will also affect corrections made in Bass Focus.
- Bass Focus mode is automatically cancelled if no operation is performed within 15 seconds.

Example setting for steps 4 and 5

- (1) Press **BAND/TEL.** to select the front (left and right) speakers. Then turn the Rotary encoder to select 1.5 ms (Delay no. 15 in the table). The time difference is 1.5 ms for both front (left and right) speakers.

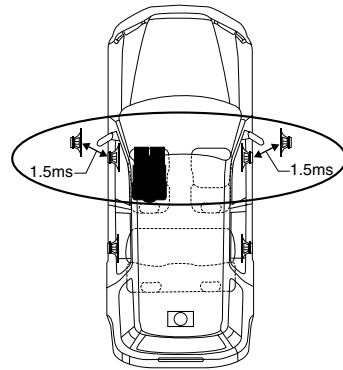

- (2) Press **BAND/TEL.** to select the left (front and rear) speakers. Then turn the Rotary encoder to select 1.5 ms (Delay no. 15 in the table). The time difference is 3.0 ms*¹ for the front left speaker, and 1.5ms for the left rear speaker, creating the impression of an equal listening between the front left speaker and the other speakers.

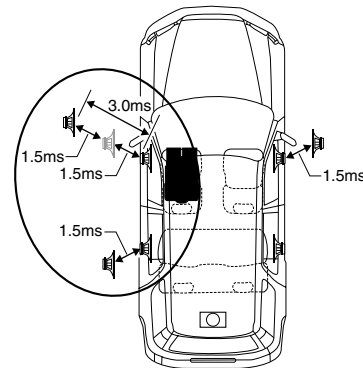

*¹ Because the time difference was already set to 1.5ms for the front left speaker to begin with, the additional correction of 1.5ms makes the total time difference of the front left speaker 3.0ms.

Continued

Time Difference Table

Delay Number	Time Difference (ms)	Distance cm (inch)	Delay Number	Time Difference (ms)	Distance cm (inch)
0	0.0	0.0	51	5.1	174.9 (68-7/8")
1	0.1	3.4 (1-3/8")	52	5.2	178.4 (70-1/4")
2	0.2	6.9 (2-3/4")	53	5.3	181.8 (71-9/16")
3	0.3	10.3 (4-1/16")	54	5.4	185.2 (72-7/8")
4	0.4	13.7 (5-3/8")	55	5.5	188.7 (74-1/4")
5	0.5	17.2 (6-13/16")	56	5.6	192.1 (75-5/8")
6	0.6	20.6 (8-1/8")	57	5.7	195.5 (77")
7	0.7	24.0 (9-7/16")	58	5.8	198.9 (78-5/16")
8	0.8	27.4 (10-13/16")	59	5.9	202.4 (79-11/16")
9	0.9	30.9 (12-3/16")	60	6.0	205.8 (81")
10	1.0	34.3 (13-1/2")	61	6.1	209.2 (82-3/8")
11	1.1	37.7 (14-13/16")	62	6.2	212.7 (83-3/4")
12	1.2	41.2 (16-1/4")	63	6.3	216.1 (85-1/16")
13	1.3	44.6 (17-9/16")	64	6.4	219.5 (86-3/8")
14	1.4	48.0 (18-7/8")	65	6.5	223.0 (87-3/4")
15	1.5	51.5 (20-1/4")	66	6.6	226.4 (89-1/8")
16	1.6	54.9 (21-5/8")	67	6.7	229.8 (90-1/2")
17	1.7	58.3 (22-15/16")	68	6.8	233.2 (91-13/16")
18	1.8	61.7 (24-1/4")	69	6.9	236.7 (93-3/16")
19	1.9	65.2 (25-5/8")	70	7.0	240.1 (94-1/2")
20	2.0	68.6 (27")	71	7.1	243.5 (95-7/8")
21	2.1	72.0 (28-3/8")	72	7.2	247.0 (97-1/4")
22	2.2	75.5 (29-11/16")	73	7.3	250.4 (98-9/16")
23	2.3	78.9 (31-1/16")	74	7.4	253.8 (99-7/8")
24	2.4	82.3 (32-3/8")	75	7.5	257.3 (101-1/4")
25	2.5	85.8 (33-3/4")	76	7.6	260.7 (102-5/8")
26	2.6	89.2 (35-1/8")	77	7.7	264.1 (104")
27	2.7	92.6 (36-7/16")	78	7.8	267.5 (105-5/16")
28	2.8	96.0 (37-3/4")	79	7.9	271.0 (106-11/16")
29	2.9	99.5 (39-13/16")	80	8.0	274.4 (108-1/16")
30	3.0	102.9 (40-1/2")	81	8.1	277.8 (109-3/8")
31	3.1	106.3 (41-7/8")	82	8.2	281.3 (110-3/4")
32	3.2	109.8 (43-1/4")	83	8.3	284.7 (112-1/16")
33	3.3	113.2 (44-9/16")	84	8.4	288.1 (113-1/16")
34	3.4	116.6 (45-7/8")	85	8.5	291.6 (114-3/4")
35	3.5	120.1 (47-5/16")	86	8.6	295.0 (116-1/8")
36	3.6	123.5 (48-5/8")	87	8.7	298.4 (117-1/2")
37	3.7	126.9 (49-15/16")	88	8.8	301.8 (118-13/16")
38	3.8	130.3 (51-5/16")	89	8.9	305.3 (120-3/16")
39	3.9	133.8 (52-11/16")	90	9.0	308.7 (121-1/2")
40	4.0	137.2 (54")	91	9.1	312.1 (122-7/8")
41	4.1	140.6 (55-3/8")	92	9.2	315.6 (124-1/4")
42	4.2	144.1 (56-3/4")	93	9.3	319.0 (125-9/16")
43	4.3	147.5 (58-1/16")	94	9.4	322.4 (126-7/8")
44	4.4	150.9 (59-3/8")	95	9.5	325.9 (128-5/16")
45	4.5	154.4 (60-3/4")	96	9.6	329.3 (129-5/8")
46	4.6	157.8 (62-1/8")	97	9.7	332.7 (131")
47	4.7	161.2 (63-7/16")	98	9.8	336.1 (132-5/16")
48	4.8	164.6 (64-3/4")	99	9.9	339.6 (133-11/16")
49	4.9	168.1 (66-3/16")			
50	5.0	171.5 (67-1/2")			

Adjusting and Storing the Time Correction

Before performing the following procedures, refer to "About Time Correction" (page 20).

- 1 Press and hold **MENU** for at least 2 seconds.
- 2 Press **MENU** to select Bass Focus mode or Time Correction mode.

- 3 Press **◀◀** or **▶▶** to make time corrections.

Each press changes the mode as follows:

Bass Focus mode ↔ Time Correction mode

- 4 Press **BAND/TEL.** to select a speaker to be adjusted.

CDA-9835R

F - L → F - R → R - L → R - R → SW - L → SW - R → F - L

CDA-9833R

Front - L → Front - R → Rear - L → Rear - R → SUBW - L → SUBW - R → Front - L

- 5 Turn the **Rotary encoder** to adjust the desired time correction value.

To store the adjusted contents

- 1) Press and hold, for at least 2 seconds, any one of the preset button (1 or 6) into which you wish to store the adjusted contents.

- 6 Repeat step 4 and 5 to set another speaker.

- 7 Press the **Rotary encoder** to confirm the adjusted contents.

The adjusted contents are not stored if the Rotary encoder is not pressed.

- 8 After setting, press and hold **MENU** for at least 2 seconds to return to normal mode, or press **MENU** and select **RETURN** to return to normal mode.

- If no operation is performed in 15 seconds, the unit returns to normal mode.

Recalling the Stored Time Correction Settings

- 1 Press and hold **MENU** for at least 2 seconds.
- 2 Press **MENU** to select Bass Focus mode or Time Correction mode.

- 3 Press **◀◀** or **▶▶** to make time corrections.

Each press changes the mode as follows:

Bass Focus mode ↔ Time Correction mode

- 4 Press the **preset buttons (1 through 6)** that has your desired time correction in memory.

- 5 Press and hold **MENU** for at least 2 seconds to return to normal mode, or press **MENU** and select **RETURN** to return to normal mode.

- Time Correction mode is automatically cancelled if no operation is performed within 15 seconds.

Setting the MX Mode

MX (Media Xpander) makes vocals or instruments sound distinct regardless of the music source. The FM radio, CD, and MP3, will be able to reproduce the music clearly even in cars with a lot of road noise.

- 1 Press **MX** to select **MX ON**.
- 2 Press **SOURCE/POWER** to select the source to which you want to apply **MX (Media Xpander)**.
- 3 Press and hold **MX** for at least 2 seconds to activate the level setting mode.
- 4 Turn the **Rotary encoder** to select your preferred level or **OFF**.

FM (MX level 1 to 3):

The medium to high frequencies become clearer, and produces well balanced sound at all frequencies.

CD/WAV (MX level 1 to 3):

CD mode processes a large amount of data during playback. MX takes advantage of this large data quantity to reproduce a more clear, clean output.

MP3/WMA (MX level 1 to 3):

This corrects information that was lost at the time of compression. This reproduces a well-balanced sound close to the original.

DVD (Video CD)

(MOVIE MX level 1 to 2):

The dialogue portion of a video is reproduced more clearly.

(MUSIC MX level 1):

A DVD or Video CD contains a large quantity of data such as music clip. MX uses this data to reproduce the sound accurately.

AUX (MX level 1):

Choose the MX mode (MP3, MUSIC, or MOVIE) that corresponds to the media connected.
If two external devices are connected, a different MX mode for each media can be selected.

5 Press **Rotary encoder** to return to normal mode.

- To cancel MX mode for all music sources, press **MX** to turn MX off.
- MX mode is automatically cancelled if no buttons are pressed within 15 seconds.
- Each music source, such as FM radio, CD, and MP3/WMA can have its own MX setting.
- On disks with both MP3/WMA and CD-DA, when the source changes from "MP3/WMA to CD-DA" or "CD-DA to MP3/WMA", MX-mode switching may delay playback slightly.
- Setting to **MX OFF** sets MX mode of each music source to **OFF**.
- This function is inoperable when **DEFEAT** is set to **ON**.
- There is no MX mode for **MW, LW** radio.
- If an audio processor with the MX function (PXA-H700, etc.) is connected, its own MX processing is applied to the music source. Since the processor MX settings may not match the head unit, the audio processor needs to be adjusted. For details, refer to the Owner's Manual of the audio processor.
- When entering RDS signals, the MX operation cannot be performed.

Other Functions

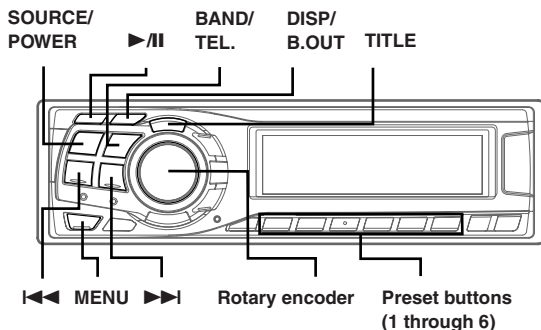

Displaying the Title/Text

It is possible to display the CD/Station title if the title has been previously inputted ("Titling Discs/Stations" page 25). Text information, such as the disc name and the track name, will be displayed if playing a CD text compatible disc. It is also possible to display the folder name, the file name, and the tag, etc., while playing MP3/WMA files.

Press **TITLE**.

The display will change every time the button is pressed.

The display in Radio mode:

CDA-9835R^{*1}

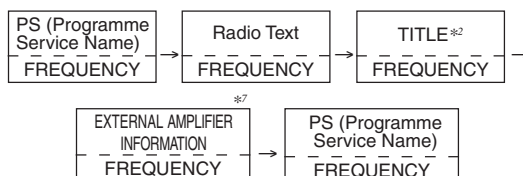

CDA-9833R

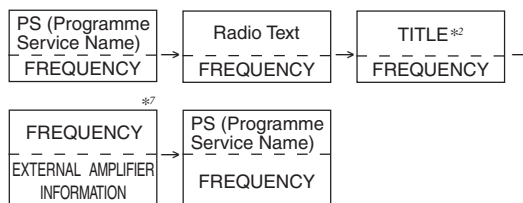

The display in CD mode:

CDA-9835R^{*1}

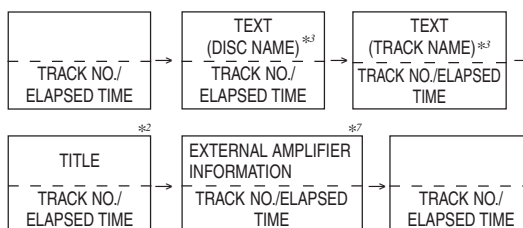

Continued

CDA-9833R

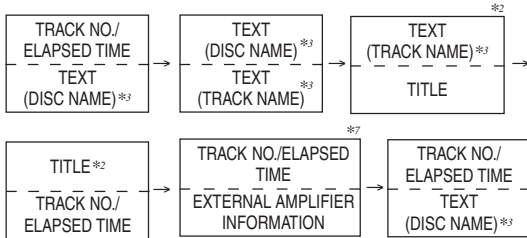

The display in MP3/WMA mode:

CDA-9835R*1

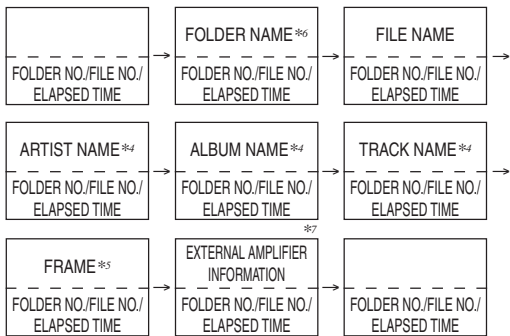

CDA-9833R

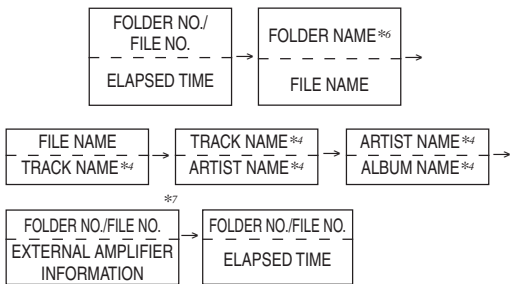

*1 The display example for the normal display mode is described. The display changes depending on the display indication pattern. (See "Switching the Display modes" on page 6)

*2 TITLE can be input or erased.

*3 Displayed during playback of a disc with CD Text. "NO TEXT" will be displayed when the CD contains no Text data.

*4 ID3 tag/WMA tag
If an MP3/WMA file contains ID3 tag/WMA tag information, the ID3 tag/WMA tag information is displayed (e.g., track name, artist name, and album name). All other tag data is ignored. "NO DATA" will be displayed when an MP3/WMA file contains no ID3 tag/WMA tag information.

*5 The recording sampling rate and bit rate of the MP3/WMA file are displayed.

*6 "0 (zero)" is displayed for the folder name of the root folder.

*7 Only when an external Amplifier Link compatible amplifier is connected. For details, refer to "Displaying the External Amplifier Information" (page 26).

About the indicator display (CDA-9833R only)

When displaying Title/Text, the following indicators are lit according to the mode.

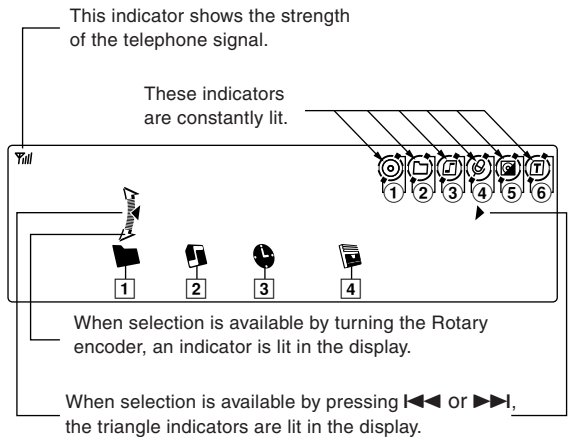

- ① This indicator is lit when a folder or playlist number is displayed.
- ② This indicator is lit when a track (file) number is displayed.
- ③ This indicator is lit when the elapsed playback time is displayed.
- ④ This indicator is lit when the temperature of the connected an external Amplifier Link compatible amplifier is displayed.

Indicator/ Mode	CD Mode	MP3/WMA Mode	TUNER Mode
①	While displaying Title	—	—
②	—	While displaying Folder Name	—
③	—	While displaying File Name	—
④	—	While displaying Artist Name*	—
⑤	While displaying Text (Disc Name)	While displaying Album Name*	—
⑥	While displaying Text (Track Name)	While displaying Track Name*	While displaying Title

*Tag information

About "Title" and "Text"

Title:

With this device, it is possible to input the CD/Station name (page 25). This inputted name is referred to as a "title." You cannot input or display titles on MP3/WMA discs.

Text:

Text compatible CDs contain text information such as the disc name and track name. Such text information is referred to as "text."

- Some characters may not be displayed correctly with this device, depending on the character type.
- The CD changer must also be CD Text compatible for the Text information to be displayed.
- When the Scroll Setting (page 30) is set to "SCROLL MANUAL," press and hold **TITLE** for at least 2 seconds to scroll the Text information only once (TEXT DISPLAY, FOLDER NAME DISPLAY, FILE NAME DISPLAY or TAG DISPLAY mode).
- "NO SUPPORT" is displayed when the desired text information cannot be displayed on this unit.
- If the title was not previously input, "NO TITLE" is displayed.
- The text or tag information may not be correctly displayed, depending on the contents.

Titling Discs/Stations

It is possible to title your favourite CD's or radio stations.
You cannot input titles on MP3/WMA discs.

1 Press TITLE and select the Title Display.

For details, see asterisk 2 of "Displaying the Title/Text" (page 23).

2 Press and hold TITLE for at least 2 seconds. The first character will blink.

3 Press BAND/TEL. to select the characters/symbols.

Upper case → Lower case → Numeral/Symbol → Upper case

4 Turn the Rotary encoder to select the desired letter/numeral/symbol available for naming.

Press I◀◀ or ▶▶I to turn the page.

5 Press Rotary encoder to store the first character.

The first character will stop blinking and the display will automatically advance to the next character. When that character begins to blink, you may choose the next letter or symbol of your title.

6 Repeat steps 3 and 5 above to complete the titling.

Pressing the Rotary encoder after entering the 8th character (the maximum number of characters that can be input for CDA-9835R is 16) automatically stores the title into memory.

When entering a title of less than 8 or 16 characters (for example, 3 character title):

After entering 3 characters, the 4th character space will be blinking. Go to step 7 to complete the title.

7 Press TITLE to record the title.

- If you cancel while entering a title, selected characters are not written.
- You can enter 18 radio station titles (24 for the CDA-9833R model) and 18 CD titles on this unit. If you try to store beyond the limit, the display will show "FULL DATA." At this point, no more titles can be stored. To input a new title, one of the previously inputted titles must first be deleted.
- The CD Changer title length or memory capacity varies depending upon the model being used.
- When you want to erase a title, enter a space (and symbol "■" for the CDA-9833R model).
- The operations described in steps 3 to 6 must be made within 10 seconds. The input mode will be cancelled if no action is taken for over 10 seconds.

Erasing Disc Title/Station Title

1 Press TITLE to select the Title Display. Then, press again and hold for at least 2 seconds.

- For details, see asterisk 2 of "Displaying the Title/Text" (page 23).

2 Press and hold ►/II for at least 2 seconds.
The title in the display will blink.

3 Press I◀◀ or ▶▶I repeatedly until the title you want to erase is displayed.

4 Press and hold ►/II for at least 2 seconds to erase the title displayed.

5 Press TITLE to cancel the title erasing mode.

- You cannot erase CD-TEXT.
- "NO DATA" is displayed for 2 seconds if the title is not input in step 2, or all titles are erased in step 4.

Blackout Mode On and Off

When Blackout mode is turned on, the display will turn off to reduce power consumption.

This additional power enhances the sound quality.

Press and hold DISP/B.OUT for at least 2 seconds to activate the blackout mode.

The display will turn off.

- If any button on the unit is pressed during the blackout mode, the function will be displayed for 5 seconds to show the operation before returning to Blackout mode.

To cancel Blackout mode, press and hold DISP/B.OUT for at least 2 seconds.

Setting an Amplifier Link

With an external Amplifier Link compatible amplifier MRD-M501 or MRD-M301 is connected, the amplifier settings are adjustable from the head unit. A maximum of 8 external amplifiers can be adjusted.

- 1 Press and hold **MENU** for at least 2 seconds.
- 2 Press **MENU** to select A-Link.
- 3 Press **◀◀** or **▶▶** to select AMP1 to 8, or BASS VOLUME.

To set the BASS VOLUME

- 4 Turn the **Rotary encoder** to adjust the level, then press the **Rotary encoder**.
- 5 When adjustment has been completed, press and hold **MENU** for at least 2 seconds to return to normal mode, or press **MENU** and select **RETURN** to return to normal mode.

To set the Amplifier

- 4 Press **BAND/TEL.** to select from the following setting items to be adjusted.
INPUT → LOW PASS → SUBSONIC → P-EQ → BASS COMP → T.CORR → PHASE → TURN ON DELAY → OUTPUT DISABLE (SAFE) → INPUT
- 5 Turn the **Rotary encoder** to change the settings.
- 6 Press the **Rotary encoder**.
Repeat steps 5 and 6 (above) if there are other items to set in step 4.
- 7 Repeat the steps 4 to 6 (above) if other settings need to be adjusted.
To set another amplifier, return to the step 3.

To store the adjusted contents

- 1) While adjusting the mode, press and hold either button (1 or 2) for at least 2 seconds.
The adjusted contents are stored.

To recall adjusted and stored contents

- 1) While adjusting the mode, press either button (1 or 2).
The adjusted and stored contents are recalled.

- 8 When adjustment has been completed, press and hold **MENU** for at least 2 seconds to return to normal mode, or press **MENU** and select **RETURN** to return to normal mode.

To easily recall adjusted and stored contents

- 1) Press **MENU** to select A-Link.
- 2) Press **◀◀** or **▶▶** to select AMP 1 to 8.
- 3) Turn the **Rotary encoder** to select Preset 1 or Preset 2.
- 4) Press and hold **MENU** for at least 2 seconds to return to normal mode, or press **MENU** and select **RETURN** to return to normal mode.

- For details of each of the settings, refer to the Owner's Manual of the external amplifier.
- If amplifier settings are made on the unit, do not then change the setting with the amplifier buttons as the amplifier display may not match the operations of the unit.
- "No Link" is displayed if the amplifier is removed or its power cannot be turned on, etc.

Displaying the External Amplifier Information

When an external Amplifier Link compatible amplifier is connected, the external amplifier's information (voltage, electric current, temperature) can be shown in the display of the head unit.

- 1 Press **TITLE** in the Radio or CD mode to switch the display of the external amplifier information.

- For switching the display, refer to the section "Displaying the Title/Text" (page 23).

CDA-9835R

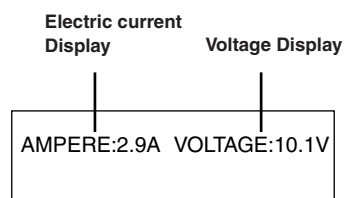

- The temperature display is indicated for animation display pattern1 and animation display pattern2 in the section "Switching the Display modes" (page 6).

CDA-9833R

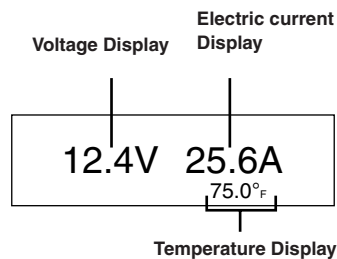

- To switch the display between Celsius and Fahrenheit, refer to page 30.

Setting the Multicolour Illumination

You can change the lighting colour of the following four buttons : SOURCE/POWER, BAND/TEL, ◀◀ and ▶▶.

- 1 Press **MENU** to select Illumination.
- 2 Press ◀◀ or ▶▶ to select your desired colour.

BLUE ↔ GREEN ↔ AMBER ↔ RED ↔ (USER'S*) ↔ BLUE

* You can use your desired colours as shown below if you have already registered to USER'S.

If you want to use colours other than the above

- 3 Turn the **Rotary encoder** to select colours (1 through 512).
Each press of BAND/TEL. advances the colour number by 30.

1.....19.....184.....363.....512
(Red) (Amber) (Green) (Blue)

To store the setting contents

- 1) Press and hold, for at least 2 seconds, any one of the preset buttons (1 through 6).
The setting contents are stored.

To recall the stored colour setting

- 1) While setting the mode, press any one of the preset buttons (1 through 6).
The stored setting contents are recalled.

- 4 When adjustment has been completed, press and hold **MENU** for at least 2 seconds to return to normal mode, or press **MENU** and select **RETURN** to return to normal mode.

• “No Memory” is displayed if a preset that has not been stored is recalled.

Changing the Lighting Colour of All the Buttons

You can change the lighting colour of the unit.

- 1 Press **MENU** to select Illumination.
- 2 Press **SOURCE/POWER**.
The lighting colour of all the buttons are changed.
AMBER ON ↔ AMBER OFF (Green)
- 3 When adjustment has been completed, press and hold **MENU** for at least 2 seconds to return to normal mode, or press **MENU** and select **RETURN** to return to normal mode.

• SOURCE/POWER, BAND/TEL, ◀◀ and ▶▶ buttons are changed to that which you have set above in “Setting the Multicolour Illumination (this page).”

Verifying the Software Version

Current version software can be verified in the display.

- 1 Press and hold **MENU** for at least 2 seconds.
- 2 Press **MENU** to select Information.
The version is displayed.
- 3 Press and hold **MENU** for at least 2 seconds to return to normal mode, or press **MENU** and select **RETURN** to return to normal mode.

i-Personalize™ Operation

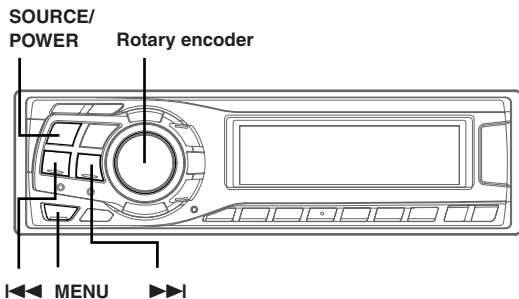

About i-Personalize™

You can download data (from Alpine's website) to a CD-R, and download and store the data to the CDA-9835R/CDA-9833R. To start i-Personalize, access the URL below and follow the on-screen instructions.

<http://www.alpine.com> or <http://www.alpine-europe.com> or <http://www.alpine.com.au>

Downloadable data

Parametric equalizer	Data is memorized in Preset 6 of the Parametric EQ Mode.
Time correction	Data is memorized in Preset 6 of the Time Correction Mode.
Crossover	Data is memorized in Preset 6 of the crossover mode.

The file name of download data shall be "A_W****.MP3."

A_W****.MP3

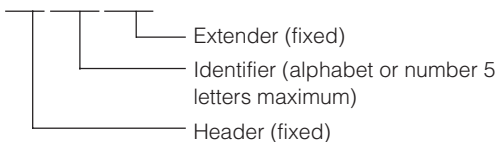

You can create a file name via the website. Do not change a file name once it has been created. Malfunction may result.

- For downloading procedure details, see ALPINE's Web site.
- If the HDA-5460 model is connected to this unit, the HDA-5460 hard disc can be used. Data that has been stored in the hard disc is downloaded by the "Data Downloading" operation to CDA-9835R/CDA-9833R. The hard disc drive (HDD) can be selected by switching the source in step 1. For details on how to download data to the hard disc, refer to the Owner's Manual of the HDA-5460 model.
- If an external audio processor is connected, data that is downloaded cannot be used.

Data Downloading

- 1 **Insert the CD-R disc containing the data.**
If the source is not the CD mode, press **SOURCE/POWER** to change to CD mode.
- 2 Press **MENU** to select the i-Personalize (Download) mode.
- 3 Press **◀◀** or **▶▶** to select "YES."
Data search of the disc starts and the first file name is displayed.
 - Selecting "NO" and pressing **MENU** will halt the download mode.
 - If a file is not found by the data search, "NO FILE" is indicated.
 - The "NO FILE" display will automatically disappear if no operation is performed for 5 seconds.
- 4 Turn the **Rotary encoder** to select files that are downloaded and then press the **Rotary encoder** to start.
Data downloading starts.
If the **MENU** is pressed while downloading, download is cancelled.
- 5 When data download is finished successfully, the confirmation screen is displayed for 5 seconds (for the CDA-9833R model, each confirmation screen of download data is sequentially displayed), and download finishes.
Successfully downloaded items are indicated as checked boxes on the confirmation screen.

PARAMETRIC EQ data
The data is memorized in Preset 6 of Parametric EQ mode. The memorized data settings in Preset 6 (Parametric EQ mode) are automatically applied.

X-OVER (Crossover) data
The data is memorized in Preset 6 of X-OVER mode. The memorized data settings in Preset 6 (X-OVER mode) are automatically applied.
You cannot download the data if the setting of the 2WAY/3WAY switch is not suitable for the data.

TIME CORRECTION data
The data is memorized in Preset 6 of the Time correction mode. The memorized data settings in Preset 6 (Time Correction mode) are automatically applied.
- 6 Press and hold **MENU** for at least 2 seconds to return to normal mode, or press **MENU** and select **RETURN** to return to normal mode.
 - When you download the data again, the data is overwritten in Preset 6.

SETUP

You can flexibly customize the unit to suit your own preferences and usage. Choose the SETUP menu from Sound Customizing, Visual Customizing, etc., to select your desired setting.

**SOURCE/
POWER BAND/TEL. Rotary encoder**

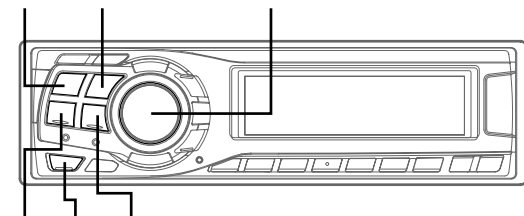

◀◀ MENU ▶▶

The common operation for SETUP is step 1 to 4 as follows. You will find further information about each SETUP menu on the page 29 and 30.

- 1 Press **MENU** to select the **SETUP** mode.
SETUP mode is activated.
- 2 Press **◀◀** or **▶▶** to select the desired **SETUP** menu.
(e.g. Select BEEP)

Here is the explanation for CDA-9835R display example.

FM-LEVEL → RDS REGIONAL^{*1} → PI SEEK^{*2} → TUNER MODE → DIMMER → SUBWOOFER → PLAY MODE → BEEP → TEXT SCROLL → INT MUTE → INT AUDIO → AUX IN → (AUX NAME)^{*3} → POWER-IC → TELEPHONE^{*4} → LCD CONTRAST^{*5} → TW SETUP → A LINK TEMP^{*6} → BGV SELECT^{*7} → DEMO → FONT SELECT^{*8} → FM-LEVEL
- 3 Turn the **Rotary encoder** to change the setting.
(e.g. Select BEEP ON or BEEP OFF.)
- 4 Press and hold **MENU** for at least 2 seconds to return to normal mode, or press **MENU** and select **RETURN** to return to normal mode.

Sound Customizing

Adjusting Source Signal Levels

FM-LEVEL HIGH (Initial setting) / FM-LEVEL LOW

If the difference in volume level between the CD player and FM radio is too great, adjust the FM signal level.

Switching the Tuner Mode

NORMAL (Initial setting) / HI-FI / STABLE

This unit incorporates the MAX TUNE PRO for the highest quality tuner audio. Moreover, you can choose between three settings to suit your own personal sound preferences and usage.

NORMAL: Standard setting
HI-FI: Sound quality priority setting
STABLE: Noiseless priority setting

- If you find the sound is very noisy while listening to the tuner in Hi-Fi mode, we recommend you change to Normal mode.

Subwoofer On and Off

SUBWOOFER ON (Initial setting) / SUBWOOFER OFF

When the subwoofer is on, perform the steps below to adjust the subwoofer output phase and level.

- 1 Press the **Rotary encoder** repeatedly to select the **SUBWOOFER** mode.

SUBWOOFER → BALANCE → FADER → DEFEAT → VOLUME → SUBWOOFER

- If you set the 2WAY/3WAY switch (pages 40 to 42) to 3WAY, you cannot adjust the FADER mode.

- 2 Press **◀◀** or **▶▶**.

The subwoofer output phase is toggled SUBWOOFER NORMAL (0°) or SUBWOOFER REVERS (180°).
To adjust the level, turn the Rotary encoder.

Setting the Subwoofer Output

STEREO (Initial setting) / MONO

You can set the subwoofer output to stereo or monoaural. Make sure to set the correct output for your subwoofer type.

STEREO: Subwoofer stereo (L/R) output
MONO: Subwoofer monaural output

Setting the Response Slope for the High Range Speaker (TW SETUP)

MAKER'S (Initial setting) / USER'S

Depending on the response characteristics of the speaker, care should be taken when setting the response slope of the high range speaker to FLAT in 3-way mode (see "Adjusting and Storing the Crossover Settings" on page 19), as speaker damage may result.

MAKER'S: As protection from possible speaker damage, FLAT cannot be set for the response slope of the high range speaker in 3-way mode.

USER'S: The FLAT setting is possible in 3-way mode.

- A message is displayed when the response slope for the high range speaker is set to FLAT in 3-way mode.

Sound (Beep) Guide Function

BEEP ON (Initial setting) / BEEP OFF

This function will give audible feedback with varying tones depending upon the button pressed.

Visual Customizing

Dimmer Control

DIMMER AUTO (Initial setting) / DIMMER MANUAL

Set the DIMMER control to AUTO to decrease the illumination brightness of the unit with the head lights of the vehicle ON. This mode is useful if you feel the unit's backlighting is too bright at night.

Continued

- If your vehicle has a dimmer control for the speedometer area, do not connect the DIMMER cable (orange) of the radio to this dimmer control.

Scroll Setting

SCROLL AUTO / SCROLL MANUAL (Initial setting)

This CD player can scroll the disc and track names recorded on CD-TEXT discs, as well as the text information of MP3/WMA files, folder names, and tags.

- SCROLL AUTO : The CD text information, the text information of folder and file names, and the tags are scrolled automatically.
- SCROLL MANUAL: The display is scrolled when a disc is loaded or when a track is changed, etc.

- The unit scrolls CD text names, folder names, file names or tag display. The disc titles input manually (page 25) cannot be scrolled.

Switching the Character Font (CDA-9833R only)

TYPE-1 (Initial setting) / TYPE-2

Two types of font can be selected.

You can select the font type you like.

Adjusting Display Contrast (CDA-9833R only)

CONTRAST

You can adjust the display contrast for better visibility.

You can adjust in a range of - 6 and + 6.

- The initial setting at the factory is "0."

Switching the Animation Display type (CDA-9835R only)

Type 1 (Initial setting) / Type 2 / Type 3 / Type 4 / Type 5

You can select your favorite animation display from five types of Pattern 1 or Pattern 2 in "Switching the Display Modes" (page 6).

Demonstration

DEMO ON / DEMO OFF (Initial setting)

This unit has a Demonstration feature for the display and sound.

- To quit Demo mode, set to DEMO OFF.

MP3/WMA

Playing MP3/WMA Data

CD-DA (Initial setting) / CD-DA/MP3

This product can playback CDs containing both CD and MP3/WMA data. However, in some situations (some enhanced CDs), playback may be difficult. For these special cases, you can select playback of CD data only. When a disc contains both CD or the MP3/WMA data, playback starts from the CD data portion of the disc.

- CD-DA : Only CD data can be played back.
- CD-DA/MP3 : Both CD data and MP3/WMA file tracks can be played back.

- Perform this setting before inserting a disc. If a disc has already been inserted, perform the setting after you remove the disc. (If you use an MP3 changer, you have to change discs.)

External Device

Turning Mute Mode On/Off

INT MUTE ON (Initial setting) / INT MUTE OFF

If a device having the interrupt feature is connected, audio will be automatically muted whenever the interrupt signal is received from the device.

Setting the AUX Mode (V-Link)

AUX ON / AUX OFF (Initial setting)

You can input TV/video sound by connecting an optional Ai-NET/RCA Interface cable (KCA-121B) or Versatile Link Terminal (KCA-410C) to this component.

You can change the AUX name display when AUX ON is set. Select the AUX name by pressing ◀◀ or ▶▶. Then turn the Rotary encoder. If the KCA-410C is connected, it is possible to select two AUX names.

- Via KCA-410C, up to 2 external devices with RCA output can be connected. In this case, press SOURCE/POWER to select AUX mode and then press BAND/TEL. to select your desired device.

Connecting to an External Amplifier

POWER-IC ON (Initial setting) / POWER-IC OFF

When an external amplifier is connected, sound quality can be improved by stopping the power supply of the built-in amplifier.

POWER-IC OFF : Use this mode when the front and rear pre-amplifier of the unit are used to drive an external amplifier connected to the speakers. In this setting, the head unit's internal amplifier has no output to drive speakers.

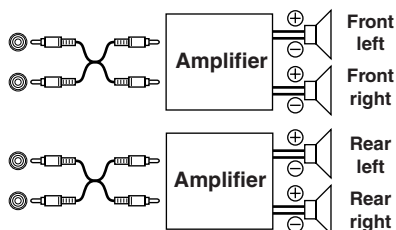

POWER-IC ON : The speakers are driven by the built-in amplifier.

Speakers

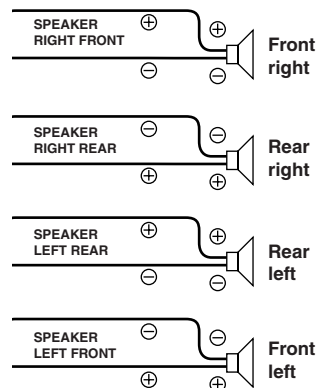

- No sound is produced by the system when the power output is set to OFF.

Setting the Temperature Display for the External Amplifier

TEMP °F/ °C (Initial setting)

When a separately sold Amplifier Link compatible amplifier is connected, you can set how to display its temperature. You can switch the setting between Fahrenheit and Celsius.

°F : The temperature is displayed in Fahrenheit.

°C : The temperature is displayed in Celsius.

Setting Tone Defeat for External Devices

INT AUDIO ON / INT AUDIO OFF (Initial setting)

When inputting external devices to this unit, turning tone defeat on will bypass EQ and MX, i.e., sound for external devices is output at the default setting.

MobileHub™ Link Operation(Optional)

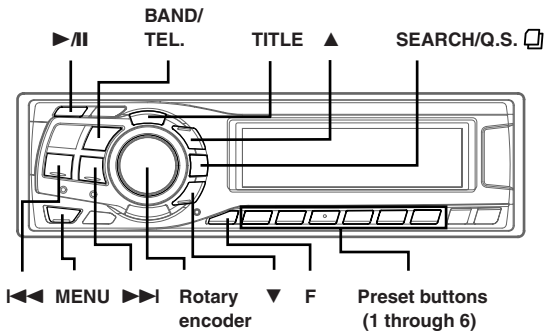

- An outgoing call from a portable telephone is also possible. However, you cannot perform different operations at the same time from a portable telephone and CDA-9835R/CDA-9833R as malfunction can result.
- With a junction box connected outgoing, incoming, and sending history will also be recorded in the portable telephone.
- While telephoning, defeat is set to ON. When the call has finished, the unit returns to your previous setting.
- The telephone volume can be adjusted on the CDA-9835R/CDA-9833R. The volume you set during the call is memorized, and is automatically applied again on the next call.
- While telephoning or receiving incoming calls, press **TITLE** to show the Network Operator display for 5 seconds.

Incoming Calls

- 1 Press **▶/II** to receive an incoming call.
- 2 Press **BAND/TEL.** to finish a call.
Telephone mode will end and return to the original source mode.

- When the Automatic Calling mode is on, you can talk after 3 seconds of receiving the incoming call. (see "Setting the Automatic Calling" on this page.)

Setting the Automatic Calling

The incoming call can be switched to Automatic Calling or Manual Calling.

- 1 Press **MENU** to select the **SETUP** mode.
- 2 Select "TELEPHONE" by pressing **◀◀** or **▶▶**.
- 3 Turn the **Rotary encoder** to change to **AUTO** or **MANUAL**.
- 4 Press and hold **MENU** for at least 2 seconds to return to normal mode, or press **MENU** and select **RETURN** to return to normal mode.

- Press **BAND/TEL.** during an incoming call to disconnect it.
- The initial setting of the factory is **MANUAL**.

About MobileHub™ Link

Connect a separately sold junction box and a portable telephone (available from Nokia) to control the incoming and outgoing calls of the portable telephone.

Caution

Even with hands-free operation, a driver can be distracted during telephone operation or receiving a call. For the sake of safety, drivers are requested to refrain from operating the telephone while driving.

For the sake of safety, only incoming calls and Speed-Dial outgoing calls can be operated.

- If a portable telephone is connected, its address book, incoming and outgoing history are downloaded to the junction box.
- Please refer to the instruction manual of the junction box.

Telephone Mode ON/OFF

- 1 Press and hold **BAND/TEL.** for at least 2 seconds to turn on the Telephone mode.

To turn off, press **BAND/TEL.**
See relevant pages for each item.

- "NO PHONE" is displayed for about 2 seconds, if a portable telephone is not connected, before entering the telephone mode. Then the mode returns to the original source mode.
- When the portable telephone is taken off the junction box during an incoming or outgoing call, or during a hands-free call, the call will be treated as an ordinary one by the portable telephone.
- When there is an incoming call while the power of CDA-9835R/CDA-9833R is off, the power of CDA-9835R/CDA-9833R will turn on automatically for a hands-free call.
- Even if the power of the portable telephone is off, when CDA-9835R/CDA-9833R is set to Telephone mode, the power of the portable telephone will be turned on.
- Even if the ACC power of the vehicle is turned off (even if the engine is stopped) during a hands-free call, the call is not disconnected, and an ordinary call by the portable telephone is possible.
- If there is an incoming call during operation (except an outgoing call or talking), operation mode will end and switch to the incoming or talking mode.

Calling

Calling by the address book

You can call up the address book registered in the portable telephone to call from.

- 1 Press and hold **BAND/TEL.** for at least 2 seconds.
- 2 Press **SEARCH/Q.S.**  to select Phone Book mode.
A list in alphabetic order is displayed.

Retrieving an addressee by Alphabetic Sort List

- 3 When displaying the Alphabetic Sort List, turn the **Rotary encoder** or press **◀◀** or **▶▶** to select the addressee.
- 4 Press **▶/II** or **Rotary encoder** to place a call.
- 5 Press **BAND/TEL.** to end the call.
Telephone mode will end and return to the original source mode.

Retrieving an addressee by Selecting Search (A-Z search)

- 3 Press **▲** or **▼** to select an initial letter (A to Z) of the addressee.
 - 4 Turn the **Rotary encoder** to select the addressee.
 - 5 Press **▶/II** or **Rotary encoder** to place a call.
 - 6 Press **BAND/TEL.** to end the call.
Telephone mode will end and return to the original source mode.
- If all telephone numbers and registered names cannot be displayed at once, press **TITLE** to show undisplayed numbers and names.
 - “NO MEMORY” is displayed if nothing is registered in the Phone Book.

Calling by using the Speed Dial

You can place a call by retrieving one of the telephone numbers registered in No. 1 to 9 of the address book.

- 1 Press and hold **BAND/TEL.** for at least 2 seconds.
 - 2 Within 5 seconds, place a call by pressing and holding the desired **preset button (1 through 6)** for at least 2 seconds.
By pressing **F**, and then pressing a **preset button (1 through 3)** for at least 2 seconds, you can place a call to the number registered in 7 to 9.
- You can place a call by pressing **▶/II** after momentarily pressing the **preset button (1 through 6)** of the number you wish to call.
 - You can place a call by pressing the **Rotary encoder**, after selecting a number which you wish to call, by pressing **◀◀** or **▶▶**, or by turning the **Rotary encoder**.
- 3 Press **BAND/TEL.** to end the call.
Telephone mode will end and return to the original source mode.
- If there is no telephone number registered to a preset button, “NO PRESET” is displayed when you try to place a call.

Calling by the outgoing/incoming/absent incoming history

You can place a call to any of the last 999 calls by the outgoing/incoming/absent incoming history.

- 1 Press **SEARCH/Q.S.**  in Phone Book mode to select the History mode.
 - 2 Press **▲** or **▼** to select outgoing history (display example: “DIALED”), incoming history (display example: “RECEIVED”), absent incoming history (display example: “MISSED”).
 - 3 Turn the **Rotary encoder**, or press **◀◀** or **▶▶** to select the addressee from the outgoing or incoming history.
 - 4 Press **▶/II** or the **Rotary encoder** to place a call.
 - 5 Press **BAND/TEL.** to end the call.
Telephone mode will end and return to the original source mode.
- If all telephone numbers and registered names cannot be displayed at once, press **TITLE** to show undisplayed numbers and names.
 - “NO MEMORY” is displayed if there is no incoming history.

SMS (Short Message Service) Operation

You can be informed when you receive a short message.

Receiving a short message

- 1 When a text message is received, “NEW MESSAGE” is indicated on the display.
The contents of the received message can only be read from the portable phone’s display.
- 2 Press any one of the buttons on the unit to cancel the display. The buttons that are pressed will enter the mode or will be activated.

Changer (Optional)

SOURCE/
POWER ►/II BAND/TEL.

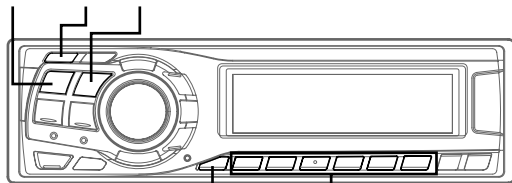

F Select buttons (1 through 6)

Controlling CD Changer (Optional)

An optional 6-disc or 12-disc CD Changer may be connected to this unit if it is Ai-NET compatible. With a CD Changer connected to the Ai-NET input of this unit, the CD Changer will be controllable from this unit.

Using the KCA-400C (Multi-Changer Switching device) or the KCA-410C (Versatile Link Terminal) multiple changers can be controlled by this unit.

See "Multi-Changer Selection" on this page for selecting the CD Changers.

- The controls on this unit for CD Changer operation are operative only when a CD Changer is connected.
- The DVD changer (optional) is controllable from this unit as well as the CD changer.

1 Press SOURCE/POWER to activate the CHANGER mode.

The display shows the disc number and track number.

- The source indicator varies depending on the connected source.
- Press BAND/TEL. to switch the Disc mode in the CD/Changer mode.

2 Press the disc select buttons (1 through 6) corresponding to one of the discs loaded in the CD Changer.

The selected disc number appears in the display and CD playback starts.

- After selecting the desired disc, you can operate in the same way as for the CD player of this unit.
For details, please see the CD/MP3/WMA section.
- If the M.I.X., REPEAT or SCAN mode is activated (the "FUNC" indicator for the CDA-9833R model is illuminated), the disc select buttons become nonfunctional.

When a 12-disc CD Changer is connected:

To select discs numbered from 1 to 6, the procedure is the same as for the 6-disc CD Changer. To select discs numbered from 7 to 12, first press F to choose the disc select mode (7 to 12). Then press the desired preset button. The preset buttons 1 to 6 will represent discs 7 to 12 respectively.

Playing MP3 Files with the CD Changer (Optional)

If you connect a changer compatible with MP3, you can play CD-ROMs, CD-Rs, and CD-RWs containing MP3 files on this unit.

1 Press SOURCE/POWER to switch to the MP3 Changer mode.

2 Press any one of the disc select buttons (1 through 6) corresponding to one of the discs loaded in the CD Changer.

3 To pause playback, press ►/II. Pressing ►/II again will resume playback.

- The unit can play discs containing both audio data and MP3 data.
- For operating MP3 with an MP3 compatible CD Changer, refer to "CD/MP3/WMA" pages 12 to 17.

Multi-Changer Selection (Optional)

Alpine's Ai-NET system will support up to 6 CD Changers. When operating two or more changers, the KCA-400C (Multi-Changer Switching device) must be used. If you use 1 Switching device, you can connect up to 4 CD Changers. If you use 2 Switching devices, you can connect up to 6 CD Changers. When using KCA-410C (Versatile Link Terminal), you can connect two changers and two external outputs (AUX).

1 Press SOURCE/POWER on this unit to activate the CD Changer mode.

Alternatively, press SOURCE on the remote control (RUE-4187) to activate the CD Changer mode.

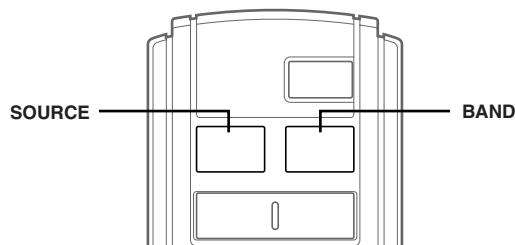

2 Press BAND/TEL. on this unit or the RUE-4187 to activate the CD Changer Selection mode.

The CD Changer Selection mode remains active for 8 seconds.

3 Press BAND/TEL. until the desired CD Changer indicator appears on the display.

Alternatively press BAND/TEL. on the Remote Control until the desired changer indicator appears on the display.

- If the selected CD Changer is not connected, the display will show "NO CHANGER."
- To operate the selected changer, see "CD/MP3/WMA" (page 12).
- For further details about the external input (AUX) when using KCA-410C, see "Setting the AUX Mode (V-Link)" on page 30.

Remote Control

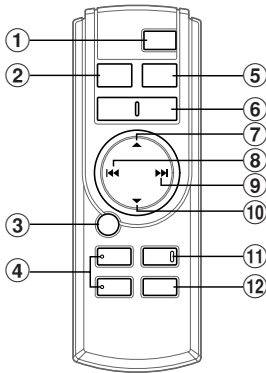

Controls on Remote Control

- ① **Power Button**
Press this button to turn the power on/off.
- ② **Source Button**
Press this button to select the audio source.
- ③ **▶/|| Button**
Press this button to switch between the Play and Pause modes for CD.
- ④ **TILT ▼▲ Buttons**
Press this button to adjust the angle of the movable display.
- ⑤ **Band/Programme Button**
Radio mode: BAND Button
Press this button and the band will change.
CD/Changer mode: To switch the disc mode.
- ⑥ **Volume Adjustment Buttons**
To increase the volume level:
Press the [▲] button

To decrease the volume level:
Press the [▼] button
- ⑦ **▲ Button**
Radio mode: Pressing this button will select, in ascending order, stations programmed into the radio's presets as shown below.
[1] → [2] ... [6] → [1]
CD Changer mode: DISC Select (UP) button
Press this button to select a disc in ascending order.
MP3/WMA mode: Press the Folder or Playlist Select (UP) button to select the folder or playlist.
- ⑧ **◀◀ DN Button**
Radio mode: SEEK (DN) Button
CD mode: Press this button to go back to the beginning of the current track.

- ⑨ **▶▶ UP Button**
Radio mode: SEEK (UP) button
CD mode: Press this button to advance to the beginning of the next track.
- ⑩ **▼ Button**
Radio mode: Pressing this button will select, in descending order, stations programmed into the radio's presets as shown below.
[6] → [5] ... [1] → [6]
CD Changer mode: DISC Select (DN) button
Press this button to select a disc in descending order.
MP3/WMA mode: Press the Folder or Playlist Select (DN) button to select the folder or playlist.

- ⑪ **Mute Button**
Press this button to lower the volume by 20 dB instantly. Press this button again to cancel.
- ⑫ **Audio Processor Button**
Each press of the button changes the audio processor mode.
For details, refer to "Operating the Audio Processor" as shown below.
Press the button to call the external audio processor mode when the external audio processor is connected.*†

*† For the operation of external audio processor, refer to the Owner's Manual of the external audio processor you purchased.

Operating the Audio Processor

- 1 Press A.PROC to select the mode.**
Normal mode → EQ mode (Equalizer Presets) → Time Correction mode (Recalling the Stored Time Correction) → Crossover mode (Recalling the Stored Crossover) → Normal mode
- 2 Press ▲ or ▼ to select the item.**
EQ mode:
Select from FLAT, ROCK, POPS, NEWS and USER'S 1 to 6.
Time Correction mode/Crossover mode:
Select from MEMORY 1 through 6.

Battery Replacement

Applicable battery: Use two "AAA" sized dry batteries or equivalent.

1 Opening the battery cover

Slide out the battery cover while firmly pressing in the direction of the arrow.

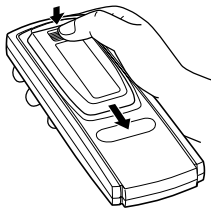

2 Replacing the battery

Insert the batteries, observing the polarities as illustrated.

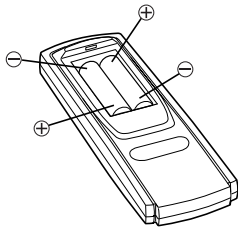

3 Closing the cover

Slide the cover as illustrated until a click is heard.

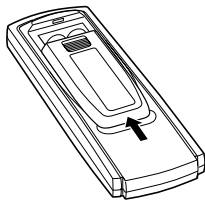

Controllable With Remote Control

Point the optional remote control transmitter at the remote control sensor.

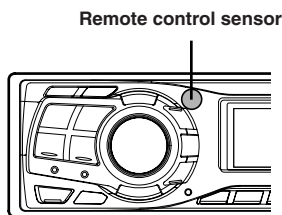

Connectable to Remote Control Interface Box

You can operate this unit from the vehicle's control unit when an Alpine Remote Control Interface Box (optional) is connected. For details, contact your Alpine dealer.

Information

In Case of Difficulty

If you encounter a problem, please turn the power off, then on again. If the unit is still not functioning normally, please review the items in the following checklist. This guide will help you isolate the problem if the unit is at fault. Otherwise, make sure the rest of your system is properly connected or consult your authorized Alpine dealer.

Basic

No function or display.

- Vehicle's ignition is off.
 - If connected following instructions, the unit will not operate with the vehicle's ignition off.
- Improper power lead (Red) and battery lead (Yellow) connections.
 - Check power lead and battery lead connections.
- Blown fuse.
 - Check the fuse on the battery lead of the unit; replace with the proper value if necessary.
- Internal micro-computer malfunctioned due to interference noise etc.
 - Press the RESET switch with a ballpoint pen or other pointed article.

Radio

Unable to receive stations.

- No antenna or open connection in cable.
 - Make sure the antenna is properly connected; replace the antenna or cable if necessary.

Unable to tune stations in the seek mode.

- You are in a weak signal area.
 - Make sure the tuner is in the DX mode.
- If the area you are in is a primary signal area, the antenna may not be grounded and connected properly.
 - Check your antenna connections; make sure the antenna is properly grounded at its mounting location.
- The antenna may not be the proper length.
 - Make sure the antenna is fully extended; if broken, replace the antenna with a new one.

Broadcast is noisy.

- The antenna is not the proper length.
 - Extend the antenna fully; replace it if it is broken.
- The antenna is poorly grounded.
 - Make sure the antenna is grounded properly at its mounting location.

CD

CD Player/Changer not functioning.

- Out of operating temperature range +50°C (+120°F) for CD.
 - Allow the vehicle's interior (or trunk) temperature to cool.

CD playback sound is wavering.

- Moisture condensation in the CD Module.
 - Allow enough time for the condensation to evaporate (about 1 hour).

Continued

CD insertion not possible.

- A CD is already in the CD player.
 - Eject the CD and remove it.
- The CD is being improperly inserted.
 - Make sure the CD is being inserted following instructions in the CD Player Operation section.

Unable to fast forward or backward the CD.

- The CD has been damaged.
 - Eject the CD and discard it; using a damaged CD in your unit can cause damage to the mechanism.

CD playback sound skips due to vibration.

- Improper mounting of the unit.
 - Securely re-mount the unit.
- The disc is very dirty.
 - Clean the disc.
- The disc has scratches.
 - Change the disc.
- The pick-up lens is dirty.
 - Do not use a commercial available lens cleaner disc. Consult your nearest ALPINE dealer.

CD playback sound skips without vibration.

- The disc is dirty or scratched.
 - Clean the disc; damaged disc should be replaced.

Error displays (built-in CD player only)

- Mechanical error
 - Press **▲**. After the error indication disappears, insert the disc again. If the above-mentioned solution does not solve the problem, consult your nearest ALPINE dealer.

CD-R/CD-RW playback not possible

- Close session (finalization) has not been performed.
 - Perform finalization and attempt playback again.

MP3/WMA

MP3 or WMA is not played back.

- Writing error occurred. The CD format is not compatible.
 - Make sure the CD has been written in a supported format. Refer to "About MP3/WMA" (pages 16-17), then rewrite in the format supported by this device.

Audio

The sound is not output from the speakers.

- Unit has no output signal of the internal amplifier.
 - POWER-IC is switched to "ON" (page 30).

Indication for CD Player

HIGH-TEMP

- Protective circuit is activated due to high temperature.
 - The indicator will disappear when the temperature returns to within operation range.

NO DISC

- No CD is inserted.
 - Insert a CD.
- Although a disc is inserted, "NO DISC" is displayed and the unit does not start to play or eject the disc.
 - Remove the disc by following these steps:
 - 1) Press the **▲** button.
The movable display will open.
 - 2) Press the **▲** button again for at least 2 seconds while the movable display is open.
If the disc still does not eject, consult your Alpine dealer.

ERROR

- Mechanism error.
 - 1) Press the **▲** button and eject the CD.
If not ejecting, consult your Alpine dealer.
 - 2) When the error indication remains after ejecting, press the **▲** button again.
If the error indication still does not turn off after pressing the **▲** button for a few times, consult your Alpine dealer.
- *When "ERROR" is displayed:
If the disc cannot be ejected by pressing **▲**, press the RESET switch (refer to page 6) and press **▲** again.
If the disc still cannot be ejected, consult your Alpine dealer.*

PROTECT

- A copy-protected WMA file was played back.
 - You can only play back non-copy-protected files.

UNSUPPORT

- The disc is not written in a MP3/WMA supported format.
 - Use a disc written at the MP3/WMA supported format.

Indication for CD Changer

HIGH-TEMP

- Protective circuit is activated due to high temperature.
 - The indicator will disappear when the temperature returns to within operation range.

ERROR - 01

- Malfunction in the CD Changer.
 - Consult your Alpine dealer. Press the magazine eject button and pull out the magazine.
Check the indication. Insert the magazine again.
If the magazine cannot be pulled out, consult your Alpine dealer.
- Magazine ejection not possible.
 - Press the magazine eject button. If the magazine does not eject, consult your Alpine dealer.

ERROR - 02

- A disc is left inside the CD Changer.
 - Press the eject button to activate the eject function. When the CD Changer finishes the eject function, insert an empty CD magazine into the CD Changer to receive the disc left inside the CD Changer.

NO MAGAZINE

- No magazine is loaded into the CD Changer.
 - Insert a magazine.

NO DISC

- No indicated disc.
 - Choose another disc.

Specifications

FM TUNER SECTION

Tuning Range	87.5 – 108.0 MHz
Mono Usable Sensitivity	0.7 μ V
Alternate Channel Selectivity	90 dB
Signal-to-Noise Ratio	65 dB
Stereo Separation	35 dB
Capture Ratio	2.0 dB

MW TUNER SECTION

Tuning Range	531 – 1,602 kHz
Sensitivity (IEC Standard)	25.1 μ V/28 dB

LW TUNER SECTION

Tuning Range	153 – 281 kHz
Sensitivity (IEC Standard)	31.6 μ V/30 dB

CD SECTION

Frequency Response	5 – 20,000 Hz (\pm 1 dB)
Wow & Flutter (% WRMS)	Below measurable limits
Total Harmonic Distortion	0.008% (at 1 kHz)
Dynamic Range	95 dB (at 1 kHz)
Signal-to-Noise Ratio	105 dB
Channel Separation	85 dB (at 1 kHz)

PICKUP

Wave length	795 nm
Laser power	CLASS I

REMOTE CONTROL

Battery Type	“AAA” sized dry battery
Battery Quantity	2
Dimensions (W \times H \times D)	42 mm (1-21/32") \times 121 mm (4-25/32") \times 23 mm (29/32")
Weight (without battery)	50 g (1.8 oz)

GENERAL

Power Requirement	14.4 V DC (11–16 V allowable)
Power Output	60 W \times 4
Maximum Pre-Output Voltage	4 V/10k ohms
Weight	1.6 kg (3 lbs. 8 oz)

CHASSIS SIZE

Width	178 mm (7")
Height	50 mm (2")
Depth	152 mm (6")

NOSEPIECE SIZE

Width	170 mm (6-11/16")
Height	46 mm (1-13/16")
Depth	18 mm (11/16")

- *Due to continuous product improvement, specifications and design are subject to change without notice.*

CAUTION

**CLASS 1
LASER PRODUCT**

(Bottom side of player)

Installation and Connections

Before installing or connecting the unit, please read the following and pages 3 to 5 of this manual thoroughly for proper use.

Warning

MAKE THE CORRECT CONNECTIONS.

Failure to make the proper connections may result in fire or product damage.

USE ONLY IN CARS WITH A 12 VOLT NEGATIVE GROUND.

(Check with your dealer if you are not sure.) Failure to do so may result in fire, etc.

BEFORE WIRING, DISCONNECT THE CABLE FROM THE NEGATIVE BATTERY TERMINAL.

Failure to do so may result in electric shock or injury due to electrical shorts.

DO NOT SPLICE INTO ELECTRICAL CABLES.

Never cut away cable insulation to supply power to other equipment. Doing so will exceed the current carrying capacity of the wire and result in fire or electric shock.

DO NOT DAMAGE PIPE OR WIRING WHEN DRILLING HOLES.

When drilling holes in the chassis for installation, take precautions so as not to contact, damage or obstruct pipes, fuel lines, tanks or electrical wiring. Failure to take such precautions may result in fire.

DO NOT USE BOLTS OR NUTS IN THE BRAKE OR STEERING SYSTEMS TO MAKE GROUND CONNECTIONS.

Bolts or nuts used for the brake or steering systems (or any other safety-related system), or tanks should NEVER be used for installations or ground connections. Using such parts could disable control of the vehicle and cause fire etc.

KEEP SMALL OBJECTS SUCH AS BATTERIES OUT OF THE REACH OF CHILDREN.

Swallowing them may result in serious injury. If swallowed, consult a physician immediately.

DO NOT INSTALL IN LOCATIONS WHICH MIGHT HINDER VEHICLE OPERATION, SUCH AS THE STEERING WHEEL OR GEARSHIFT.

Doing so may obstruct forward vision or hamper movement etc. and results in serious accident.

Caution

HAVE THE WIRING AND INSTALLATION DONE BY EXPERTS.

The wiring and installation of this unit requires special technical skill and experience. To ensure safety, always contact the dealer where you purchased this product to have the work done.

USE SPECIFIED ACCESSORY PARTS AND INSTALL THEM SECURELY.

Be sure to use only the specified accessory parts. Use of other than designated parts may damage this unit internally or may not securely install the unit in place. This may cause parts to become loose resulting in hazards or product failure.

ARRANGE THE WIRING SO IT IS NOT CRIMPED OR PINCHED BY A SHARP METAL EDGE.

Route the cables and wiring away from moving parts (like the seat rails) or sharp or pointed edges. This will prevent crimping and damage to the wiring. If wiring passes through a hole in metal, use a rubber grommet to prevent the wire's insulation from being cut by the metal edge of the hole.

DO NOT INSTALL IN LOCATIONS WITH HIGH MOISTURE OR DUST.

Avoid installing the unit in locations with high incidence of moisture or dust. Moisture or dust that penetrates into this unit may result in product failure.

Precautions

- Be sure to disconnect the cable from the (-) battery post before installing your CDA-9835R/CDA-9833R. This will reduce any chance of damage to the unit in case of a short-circuit.
- Be sure to connect the colour coded leads according to the diagram. Incorrect connections may cause the unit to malfunction or damage to the vehicle's electrical system.
- When making connections to the vehicle's electrical system, be aware of the factory installed components (e.g. on-board computer). Do not tap into these leads to provide power for this unit. When connecting the CDA-9835R/CDA-9833R to the fuse box, make sure the fuse for the intended circuit of the CDA-9835R/CDA-9833R has the appropriate amperage. Failure to do so may result in damage to the unit and/or the vehicle. When in doubt, consult your ALPINE dealer.
- The CDA-9835R/CDA-9833R uses female RCA-type jacks for connection to other units (e.g. amplifier) having RCA connectors. You may need an adaptor to connect other units. If so, please contact your authorized ALPINE dealer for assistance.
- Be sure to connect the speaker (-) leads to the speaker (-) terminal. Never connect left and right channel speaker cables to each other or to the vehicle body.

IMPORTANT

Please record the serial number of your unit in the space provided below and keep it as a permanent record. The serial number or the engraved serial number is located on the bottom of the unit.

SERIAL NUMBER: _____
INSTALLATION DATE: _____
INSTALLATION TECHNICIAN: _____
PLACE OF PURCHASE: _____

Installation

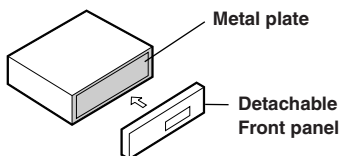

Caution

When you install this unit in your car, do not remove the detachable front panel. If the detachable front panel is removed during installation, you might press too hard and warp the metal plate that holds it in place.

Caution

Do not block the unit's fan or heat sink, thus preventing air circulation. If blocked, heat will accumulate inside the unit and may cause a fire.

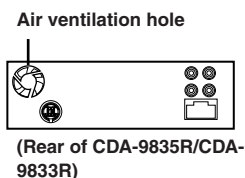

• For the screw *, provide a proper screw to the chassis installing location.

3 Slide the CDA-9835R/CDA-9833R into the dashboard. When the unit is in place, make sure the locking pins are fully seated in the down position. This can be done by pressing firmly in on the unit while pushing the locking pin down with a small screwdriver. This ensures that the unit is properly locked and will not accidentally come out from the dashboard. Install the Detachable Front Panel.

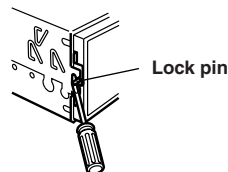

Removal

- 1 Remove the detachable front panel.
- 2 Use a small screwdriver (or similar tool) to push the locking pins to the "up" position (see above drawing). As each pin is unlocked, gently pull out on the unit to make sure it does not re-lock before unlocking the second pin.
- 3 Pull the unit out, keeping it unlocked as you do so.

1

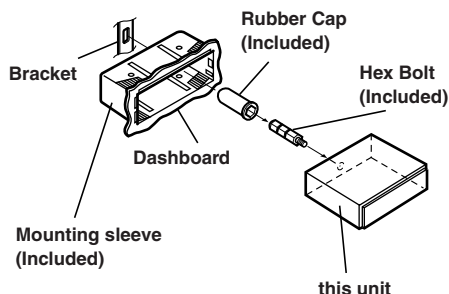

Slide mounting sleeve from main unit (see "Removal" on this page). Slide the mounting sleeve into the dashboard and fix it with the metal shackles.

<JAPANESE CAR>

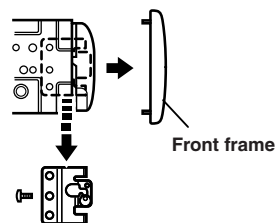

2

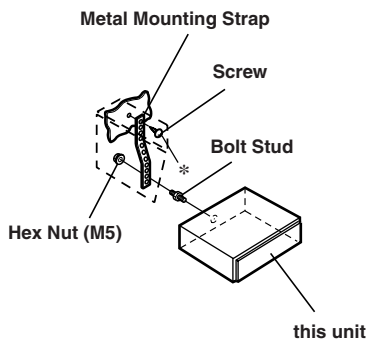

When your vehicle has the Bracket, mount the long hex bolt onto the rear panel of the CDA-9835R/CDA-9833R and put the Rubber Cap on the hex bolt. If your vehicle does not have the Mounting Support, reinforce the head unit with the metal mounting strap (not supplied). Connect all the leads of the CDA-9835R/CDA-9833R according to details described in the CONNECTION section.

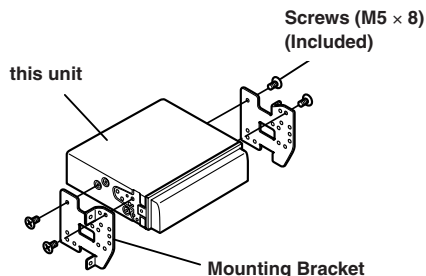

Connections

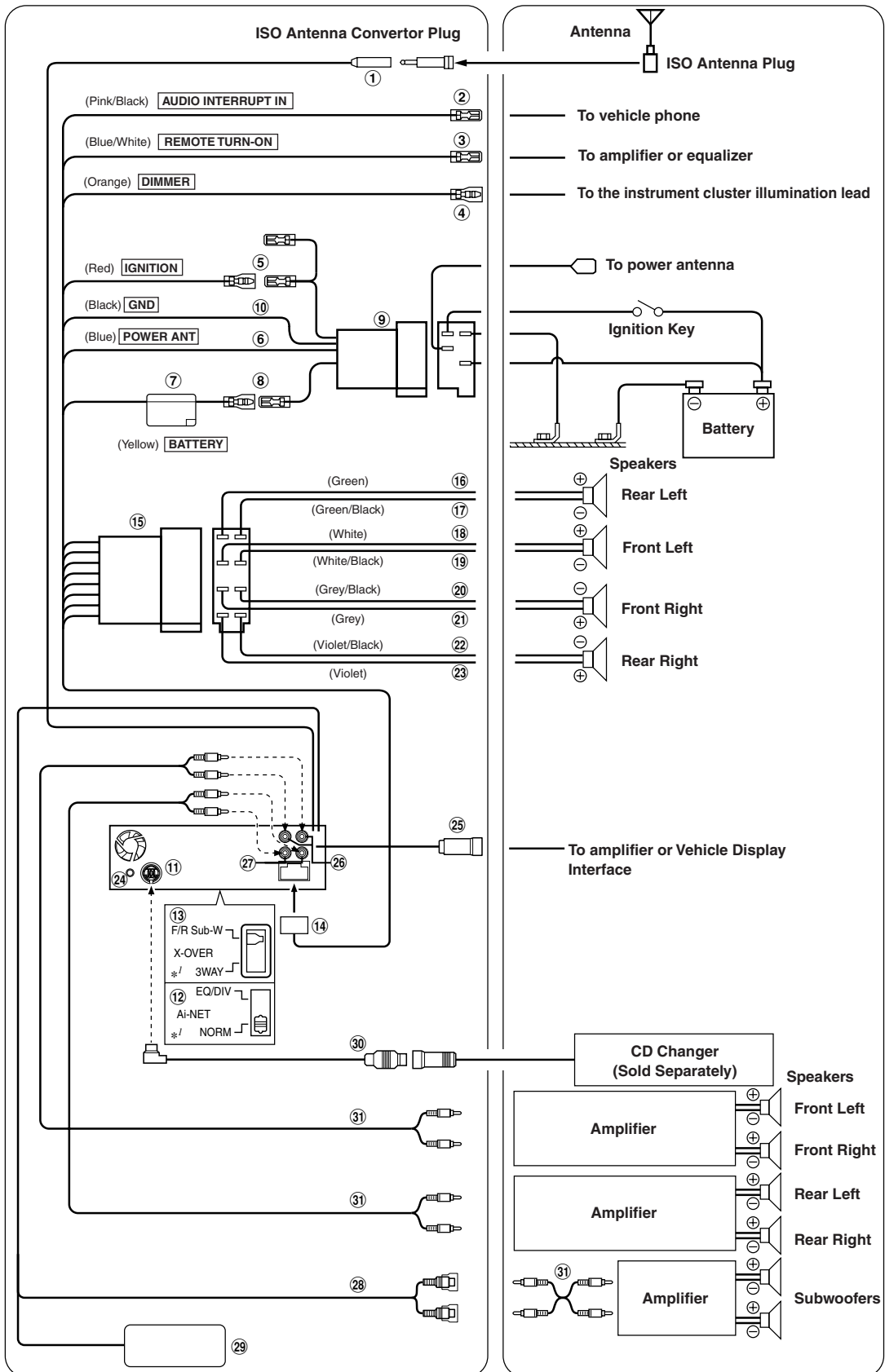

* / The label is attached on the bottom of the unit.

- ① **Antenna Receptacle**
Connect to the supplied ISO antenna convertor plug.
 - ② **Audio Interrupt In Lead (Pink/Black)**
Connect this lead to the Audio Interface output of a cellular phone which provides ground shorting when a call is received.
 - ③ **Remote Turn-On Lead (Blue/White)**
Connect this lead to the remote turn-on lead of your amplifier or signal processor.
 - ④ **Dimmer Lead (Orange)**
This lead may be connected to the light switch of the vehicle. This will enable the switched on vehicle's light to dim the backlighting of the unit.
 - ⑤ **Switched Power Lead (Ignition) (Red)**
Connect this lead to an open terminal on the vehicle's fuse box or another unused power source which provides (+) 12V only when the ignition is turned on or in the accessory position.
 - ⑥ **Power Antenna Lead (Blue)**
Connect this lead to the +B terminal of your power antenna, if applicable.
- *This lead should be used only for controlling the vehicle's power antenna. Do not use this lead to turn on an amplifier or a signal processor, etc.*
- ⑦ **Choke Coil with Fuse Holder (15A)**
 - ⑧ **Battery Lead (Yellow)**
Connect this lead to the positive (+) post of the vehicle's battery.
 - ⑨ **ISO Power Supply Connector**
 - ⑩ **Ground Lead (Black)**
Connect this lead to a good chassis ground on the vehicle. Make sure the connection is made to bare metal and is securely fastened using the sheet metal screw provided.
 - ⑪ **Ai-NET Connector**
Connect this to the output or input connector of other product (CD changer, Equalizer, etc.) equipped with Ai-NET.
 - ⑫ **System Switch**
When connecting a processor using Ai-NET, place this switch in the EQ/DIV position. When no device is connected, leave the switch in the NORM position.
- *Be sure to turn the power off to the unit before changing the switch position.*
- ⑬ **Setting the 3WAY/2WAY switch**
Set the 3way/2way Switch according to your audio system.
 - ⑭ **Power Supply Connector**
 - ⑮ **ISO Connector (Speaker Output)**
 - ⑯ **Left Rear (+) Speaker Output Lead (Green)**
 - ⑰ **Left Rear (-) Speaker Output Lead (Green/Black)**
 - ⑱ **Left Front (+) Speaker Output Lead (White)**
 - ⑲ **Left Front (-) Speaker Output Lead (White/Black)**
 - ⑳ **Right Front (-) Speaker Output Lead (Grey/Black)**
 - ㉑ **Right Front (+) Speaker Output Lead (Grey)**
 - ㉒ **Right Rear (-) Speaker Output Lead (Violet/Black)**
 - ㉓ **Right Rear (+) Speaker Output Lead (Violet)**
 - ㉔ **Remote Control Interface Connector**
To remote control interface box.
 - ㉕ **Amplifier Link / Vehicle Display Interface Connector**
Outputs Amplifier Link / Vehicle Display Interface control signals.
Amplifier Link: Connect this to an external Amplifier Link compatible amplifier, using the (also separately sold) Amplifier Link box KCE-510M.
Vehicle Display Interface: Connect this to the optional Vehicle Display Interface box.
- *Use the optional splitter cable to connect to both Amplifier Link box KCE-510M and Vehicle Display Interface box.*
 - *For details about connections, consult your nearest ALPINE dealer.*
- ㉖ **Front Output RCA Connectors**
RED is right and WHITE is left.
 - ㉗ **Rear Output RCA Connectors**
RED is right and WHITE is left.
 - ㉘ **Subwoofer Output RCA Connectors**
RED is right and WHITE is left.
 - ㉙ **DC/DC Converter (CDA-9835R only).**
- *Do not install the converter at a location subjected to water such as under the floor mat or air conditioner. This may cause a malfunction.*
 - *Do not bundle the DC/DC converter cable with other audio cables. Doing so may induce noise into your system.*
 - *Keep the DC/DC converter away from the Antenna cables and the rear side of the unit, otherwise noise may be generated when receiving radio broadcast.*
- ⑳ **Ai-NET Cable (Included with CD Changer)**
 - ㉑ **RCA Extension Cable (Sold Separately)**

Continued

The X-Over Switch position for a two-way system (frequency range is divided between highs for front/rear and lows for the Subwoofer).

The position of the X-Over switch : F/R/Sub-W

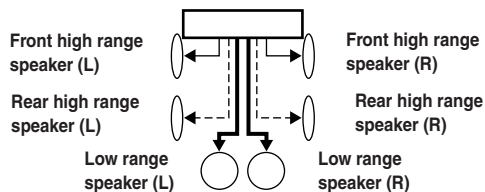

The X-Over Switch position for a three-way system whose frequency range is divided among the highs (Front), mids (Rear), and lows (Subwoofer).

The position of the X-Over switch: 3WAY

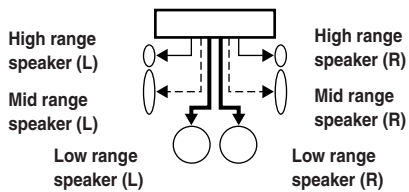

Output of this unit :

————— Front output - - - - - Rear output ——— SUB-W output

- Use the Sub-W output cord to connect the unit to the low range speaker.
- You can use the built-in amplifier to output the front output/rear output.
- You cannot adjust the fader when set to 3WAY.

To prevent noise/interference in the audio system.

- Locate the unit and route the leads at least 10 cm away from the car harness.
- Keep the battery power leads as far away from other leads as possible.
- Connect the ground lead securely to a bare metal spot (remove any paint, dirt or grease if necessary) of the car chassis.
- If you add an optional noise suppressor, connect it as far away from the unit as possible. Your Alpine dealer carries various noise suppressors, contact them for further information.
- Your Alpine dealer knows best about noise prevention measures so consult your dealer for further information.