

FOR CAR USE ONLY/NUR FÜR AUTOMOBIL GEBRAUCH/POUR APPLICATION AUTOMOBILE UNIQUEMENT/PARA USO EN AUTOMÓVILES/SOLO PER L'UTILIZZO IN AUTOMOBILE/ENDAST FÖR BILBRUK/ALLEEN VOOR GEBRUIK IN DE AUTO/ТОЛЬКО ДЛЯ ИСПОЛЬЗОВАНИЯ В АВТОМОБИЛЯХ/DO UŻYCIA TYLKO W SAMOCHODZIE



MOBILE MEDIA STATION IVE-W585BT



Alpine Tunelt App

- **OWNER'S MANUAL**
Please read before using this equipment.
- **BEDIENUNGSANLEITUNG**
Lesen Sie diese Bedienungsanleitung bitte vor Gebrauch des Gerätes.
- **MODE D'EMPLOI**
Veuillez lire avant d'utiliser cet appareil.
- **MANUAL DE OPERACIÓN**
Léalo antes de utilizar este equipo.
- **ISTRUZIONI PER L'USO**
Si prega di leggere prima di utilizzare il attrezzatura.
- **ANVÄNDARHANDLEDNING**
Innan du använder utrustningen bör du läsa igenom denna användarhandledning.
- **GEBRUIKERSHANDLEIDING**
Lees deze aanwijzingen aandachtig alvorens dit toestel te gebruiken.
- **РУКОВОДСТВО ПО ЭКСПЛУАТАЦИИ**
Прочтите настоящее руководство перед началом использования оборудования.
- **INSTRUKCJA OBSŁUGI**
Prosimy zapoznać się z tą instrukcją przed przystąpieniem do użytkowania urządzenia.

EN

DE

FR

ES

IT

SE

NL

RU

PL

ALPINE ELECTRONICS MARKETING, INC.

1-7, Yukigaya-Otsukamachi, Ota-ku,
Tokyo 145-0067, JAPAN
Phone: 03-5499-4531

ALPINE ELECTRONICS OF AMERICA, INC.

19145 Gramercy Place, Torrance,
California 90501, U.S.A.
Phone 1-800-ALPINE-1 (1-800-257-4631)

ALPINE ELECTRONICS OF AUSTRALIA PTY. LTD.

161-165 Princes Highway, Hallam
Victoria 3803, Australia
Phone 03-8787-1200

ALPINE ELECTRONICS GmbH

Wilhelm-Wagenfeld-Str. 1-3, 80807 München, Germany
Phone 089-32 42 640

ALPINE ELECTRONICS OF U.K. LTD.

Alpine House
Fletchamstead Highway, Coventry CV4 9TW, U.K.
Phone 0870-33 33 763

ALPINE ELECTRONICS FRANCE S.A.R.L.

(RCS PONTOISE B 338 101 280)
98, Rue de la Belle Etoile, Z.I. Paris Nord II,
B.P. 50016, 95945 Roissy Charles de Gaulle
Cedex, France
Phone 01-48638989

ALPINE ITALIA S.p.A.

Viale C. Colombo 8, 20090 Trezzano
Sul Naviglio (MI), Italy
Phone 02-484781

ALPINE ELECTRONICS DE ESPAÑA, S.A.

Portal de Gamarra 36, Pabellón, 32
01013 Vitoria (Alava)-APDO 133, Spain
Phone 945-283588

Contents

Operating Instructions

WARNING

WARNING	7
CAUTION	7
NOTICE	8
Discs Playable on This Unit	9

Getting Started

Accessory List	13
Location of Controls	13
Turning Power On or Off	13
Turning the System On	14
Initial System Start-Up	14
Inserting/Ejecting a Disc	14
Inserting the Disc	14
Removing the Disc	14
Adjusting the Volume	14
Lowering Volume Quickly	14
Top banner and Bottom banner Fade Out Setting	15
Switching Sources	15
Screen Off Function	15
About Sound Menu button	15
Touch Operation	16
Selecting an Item in a List	16
About the Indicator Display	16

Radio

Listening to the Radio	17
Presetting Stations Manually	17
Presetting Stations Automatically	17
Tuning to Preset Stations	17

RDS

Turning AF (Alternative Frequencies) On or Off	18
Receiving Traffic Information	18
Receiving Traffic Information Manually	19
PTY (Programme Type) Tuning	19

Priority News	19
Displaying Radio Text	19

CD/MP3/WMA/AAC

Playback	20
Repeat Play	20
M.I.X. (Random Play)	20
M.I.X. ALL (Shuffle Songs) (Concerning MP3/WMA/AAC)	20
Selecting Folders (Concerning MP3/WMA/AAC)	21
Searching from CD Text	21
File/Folder Name Search (Concerning MP3/WMA/AAC)	21
About MP3/WMA/AAC	21

DVD

Playing a Disc	23
If a Menu Screen Appears	24
Numeric Keypad Input Operations	24
Displaying the Top Menu Screen	24
Displaying the Menu Screen	24
Stopping Playback (PRE STOP)	25
Stopping Playback	25
Fast-forwarding/Fast-reversing	25
Finding the Beginnings of Chapters/Tracks/ Files	25
Playing Still Frames (Pausing)	25
Slow Motion Playback	25
Selecting Folders	26
Repeat Playback	26
Searching by Title Number	26
Searching Directly by Chapter Number	26
Searching for a Desired Video File	26
Switching the Angle	27
Switching the Audio Tracks	27
Switching the Subtitles (Subsubtitle Language)	27
About DivX®	27

Setup

Setup Operation

General Setup

General Setup Operation	28
Language Setting	28
Setting the Scroll	28
Format Settings	28
Setting the Menu Language	28
Time Setting	29
Clock Display Setting	29
Setting the Clock Mode	29
Setting the Time (Hour)	29
Setting the Time (Minute)	29
Security Code Setting	29
Setting Security code	29
Setting Top banner and Bottom banner	
Display	30
Screen/LED Customize	30
Setting the Brightness of the	
Backlighting	30
Adjusting the Minimum Level of	
Backlight	30
Adjusting the Dimmer of Button Lighting at	
Night	30
Switching the Display Colour and Wallpaper	
Image (Background)	30
Visual Setting	31
Switching Display Modes	31
Adjusting Brightness	31
Adjusting Colour of Picture	31
Adjusting Image Contrast	31
About IVE-W585BT	32
Displaying the Product Information	32
Checking the DivX [®] Registration	32
Initialising the System	32
Demonstration Setup	32
Setting Demo mode to Off/On	32

Sound Setup

Sound Setup Operation	33
Car Specific Sound Setup	33
Setting the MX (Media Xpander)	34
Equalizer Presets (EQ Presets)	34
Quick Sound Setup	34
Adjusting Bass Level/Treble Level	34
Adjusting the Subwoofer Level	34
Setting the MX (Media Xpander)	35
Setting the BASS ENGINE SQ	35

Setting the BASS ENGINE Type	35
Adjusting the BASS ENGINE Level	35
Adjusting the Fader/Balance	35
Adjusting the Time Correction (TCR)	36
Adjusting the Crossover Settings	
(X-OVER)	36
Adjusting the Parametric Equalizer Curve	
(Parametric EQ)	37
Other Setting	38
Volume Setting	38
Setting the Volume for Each Source	38
Rear Speaker Setting	38
Turning Subwoofer ON/OFF	38
Setting the Subwoofer Phase	38
Setting Defeat	38
About Time Correction	38
About the Crossover	40

Source Setup

Source Setup Operation	41
Disc Setting	41
Setting of the DVD Menu Language	41
Setting of the Audio Language	41
Setting of the Subtitle Language	41
Changing the Language Setting	41
Changing the Country Code Setting	42
Setting the Rating Level (Parental Lock)	42
Setting the TV Screen Mode	42
Radio Setting	43
PI SEEK Setting	43
Receiving RDS Regional (Local)	
Stations	43
Switching the Display Language of PTY	
(Programme Type)	43
Setting PTY31 (Emergency Broadcast)	
Reception	43
Setting the TUNER (FM) Tone Quality	
(Tuner Condition)	43
AUX Setting	44
Setting the AUX Mode	44
Setting the Primary AUX Name	
(AUX Setup)	44
Setting the App Connection Method	44
RSE Setting	44
Setting the Rear Seat Entertainment	
System	44

BLUETOOTH Setup

BLUETOOTH Setup Operation	45
Displaying BLUETOOTH Information	45

Registering the BLUETOOTH Device	45
Setting the Passcode	46
Selecting the Output Speaker	46
Adjusting the Caller Volume	46
Adjusting the Microphone Level	46
Adjusting the Ring Tone Volume	46
Deleting All the Histories	47
Changing the Phone book List Order	47

Camera Setup

Camera Setup Operation	47
AUX Camera Setting	48
Setting the Camera Input	48
Guide Display ON/OFF Setting	48
Adjusting the Caution Display Location	48
Camera Interrupt Setting (Power OFF Mode)	48
About the Rear Camera Guide	49

BLUETOOTH Operation

Setup Before Using	51
About BLUETOOTH	51
About the Hands-Free Phone Before Using BLUETOOTH	51

Hands-Free Phone Control

Connecting a BLUETOOTH Device	51
Disconnecting the BLUETOOTH Connection	51
Changing the connecting BLUETOOTH Device	52
Answering a Call	52
Adjusting Ringtone Volume	52
Hanging up the Telephone	52
Calling	52
Using Short Cut Dialling to Make a Call	52
Dialling a Number In Call History	52
Dialling a Number In the Phone Book	53
Entering a Phone Number to Make a Call	53
Redial Function	53
Voice Dial Function	53
Operations During a Conversation	53
Adjusting the Speech Volume	53
Changing the Voice Output	53
DTMF (Touch-Tone) Function	54
Phone Book Function	54
Synchronising the Phone Book	54
Adding the Phone Book	54

Searching in the Phone Book	54
Deleting the Phone Book Entries	55
Assigning as a Short Cut Dialling Number	55
Call Waiting Function	56

BLUETOOTH Audio

Playback	57
Repeat Play	57
M.I.X. (Random Play)	57
Search Function	57

Auxiliary Device (Optional)

Operating Auxiliary Devices (Optional)	58
Operating an External DVD Player	59
Change to the External DVD Mode	59
About the DVD Operation Screen	59
Operating an External DVD Changer	60
Change to the External DVD Changer Mode	60
About the DVD Changer Operation Screen	60
Operating the Mobile Digital TV Receiver (DVB-T)	60
Changing to the Mobile Digital TV Receiver (DVB-T) Mode	60
About the DVB-T Operation Screen	60
Operating a TV	61
Change to the TV mode	61
About the TV Operation Screen	61
Operating a USB Player or DAB/DAB+ TUNER	61
Change to the USB-PLAYER or DAB/DAB+ Mode	61

Applying TuneIt

Launching TuneIt App.	62
Facebook Notification Function	62

Camera Operation (Optional)

Rear Camera Operation	64
Checking Rear Camera view	64
Displaying the Rear View Video while the Car is in Reverse	64

USB Memory (Optional)

Playback	65
Repeat Play	65
Random Play (M.I.X.)	66
Random Play (Shuffle Songs)	66

Searching for a Desired Song	66
Tag Search	66
File/Folder Name Search	67
Direct Up/Down Function	67
Select the Desired Folder (Folder up/down) ...	67

iPod/iPhone (Optional)

Playback	69
Searching for a Music File	69
Searching for a Desired Video File	70
Alphabet Skip Function	70
Direct Up/Down Function	70
Repeat Play	70
Random Play (Shuffle)	71
Random Play (Shuffle Songs)	71

Information

Product Software Update	72
About DVDs	72
List of Language Codes	73
List of Country Codes	74
In Case of Difficulty	76
If this Message Appears	77
Specifications	79
END USER LICENSE AGREEMENT (Microsoft)	80

Installation and Connections

Warning	82
Caution	82
Precautions	82
Installation	83
Connections	86
System Example	88

Operating Instructions

WARNING



WARNING

This symbol means important instructions. Failure to heed them can result in serious injury or death.

INSTALL THE PRODUCT CORRECTLY SO THAT THE DRIVER CANNOT WATCH TV/VIDEO UNLESS THE VEHICLE IS STOPPED AND THE EMERGENCY BRAKE IS APPLIED.

It is dangerous for the driver to watch TV/Video while driving a vehicle. Installing this product incorrectly enables the driver to watch TV/Video while driving. This may cause a distraction, preventing the driver from looking ahead, thus causing an accident. The driver or other people could be severely injured.

DO NOT WATCH VIDEO WHILE DRIVING.

Watching the video may distract the driver from looking ahead of the vehicle and cause an accident.

DO NOT OPERATE ANY FUNCTION THAT TAKES YOUR ATTENTION AWAY FROM SAFELY DRIVING YOUR VEHICLE.

Any function that requires your prolonged attention should only be performed after coming to a complete stop. Always stop the vehicle in a safe location before performing these functions. Failure to do so may result in an accident.

KEEP THE VOLUME AT A LEVEL WHERE YOU CAN STILL HEAR OUTSIDE NOISES WHILE DRIVING.

Excessive volume levels that obscure sounds such as emergency vehicle sirens or road warning signals (train crossings, etc.) can be dangerous and may result in an accident. LISTENING AT LOUD VOLUME LEVELS IN A CAR MAY ALSO CAUSE HEARING DAMAGE.

MINIMIZE DISPLAY VIEWING WHILE DRIVING.

Viewing the display may distract the driver from looking ahead of the vehicle and cause an accident.

DO NOT DISASSEMBLE OR ALTER.

Doing so may result in an accident, fire or electric shock.

USE ONLY IN CARS WITH A 12 VOLT NEGATIVE GROUND.

(Check with your dealer if you are not sure.) Failure to do so may result in fire, etc.

KEEP SMALL OBJECTS SUCH AS SCREWS OUT OF THE REACH OF CHILDREN.

Swallowing them may result in serious injury. If swallowed, consult a physician immediately.

USE THE CORRECT AMPERE RATING WHEN REPLACING FUSES.

Failure to do so may result in fire or electric shock.

DO NOT BLOCK VENTS OR RADIATOR PANELS.

Doing so may cause heat to build up inside and may result in fire.

USE THIS PRODUCT FOR MOBILE 12V APPLICATIONS.

Use for other than its designed application may result in fire, electric shock or other injury.

DO NOT PLACE HANDS, FINGERS OR FOREIGN OBJECTS IN INSERTION SLOTS OR GAPS.

Doing so may result in personal injury or damage to the product.



CAUTION

This symbol means important instructions. Failure to heed them can result in injury or material property damage.

HALT USE IMMEDIATELY IF A PROBLEM APPEARS.

Failure to do so may cause personal injury or damage to the product. Return it to your authorized Alpine dealer or the nearest Alpine Service Centre for repairing.

NOTICE

Product Cleaning

Use a soft dry cloth for periodic cleaning of the product. For more severe stains, please dampen the cloth with water only. Anything else has the chance of dissolving the paint or damaging the plastic.

Temperature

Be sure the temperature inside the vehicle is between +45°C (+113°F) and 0°C (+32°F) before turning your unit on.

Moisture Condensation

You may notice the disc playback sound wavering due to condensation. If this happens, remove the disc from the player and wait about an hour for the moisture to evaporate.

Damaged Disc

Do not attempt to play cracked, warped, or damaged discs. Playing a bad disc could severely damage the playback mechanism.

Maintenance

If you have problems, do not attempt to repair the unit yourself. Return it to your Alpine dealer or the nearest Alpine Service Station for servicing.

Never Attempt the Following

Do not grip or pull out the disc while it is being pulled back into the player by the automatic reloading mechanism.

Do not attempt to insert a disc into the unit when the unit power is off.



Inserting Discs

Your player accepts only one disc at a time for playback. Do not attempt to load more than one disc.

Make sure the label side is facing up when you insert the disc. Playing a disc while driving on a very bumpy road may result in skips, but this will not scratch the disc or damage the player.

Irregular Shaped Discs

Be sure to use round shaped discs only for this unit and never use any special shaped discs.

Use of special shaped discs may cause damage to the mechanism.



New Discs

To prevent the disc from jamming, "Disc error" is displayed if discs with irregular surfaces are inserted or if discs are inserted incorrectly. When a new disc is ejected immediately after initial loading, use your finger to feel around the inside of the centre hole and outside edge of the disc. If you feel any small bumps or irregularities, this could inhibit proper loading of the disc. To remove the bumps, rub the inside edge of the hole and outside edge of the disc with a ballpoint pen or other such instrument, then insert the disc again.

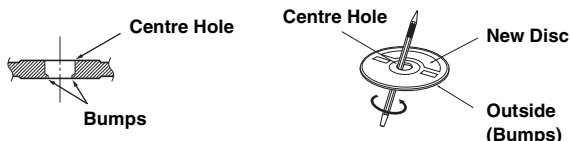

Installation Location

Make sure the IVE-W585BT will not be installed in a location subjected to:

- Direct sun and heat
- High humidity and water
- Excessive dust
- Excessive vibrations

Correct Handling

Do not drop the disc while handling. Hold the disc so you will not leave fingerprints on the surface. Do not affix tape, paper, or gummed labels to the disc. Do not write on the disc.

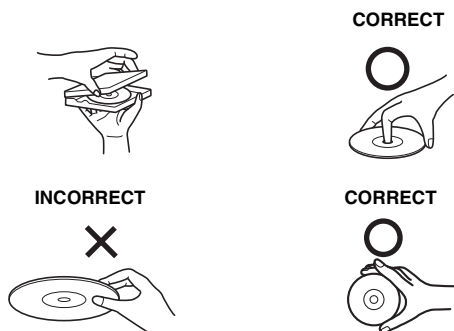

Disc Cleaning

Fingerprints, dust, or soil on the surface of the disc could cause the DVD player to skip. For routine cleaning, wipe the playing surface with a clean, soft cloth from the centre of the disc to the outer edge. If the surface is heavily soiled, dampen a clean, soft cloth in a solution of mild neutral detergent before cleaning the disc.



Disc Accessories

There are various accessories available on the market for protecting the disc surface and improving sound quality. However, most of them will influence the thickness and/or diameter of the disc. Using such accessories can cause operational problems. We recommend not using these accessories on discs played in Alpine DVD players.

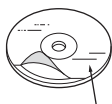

Transparent Sheet

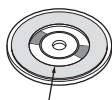

Disc Stabiliser

Operation of some of the functions of this unit is very complex. Because of this, it was deemed necessary to place these functions into a special screen. This will restrict operation of these functions to times when the vehicle is parked. This ensures the focus of the driver's attention will be on the road and not on the IVE-W585BT. This has been done for the safety of the driver and passengers. Setup operations cannot be made if the car is moving. The car must be parked and the parking brake must be engaged for the procedure described in the Owner's Manual to be valid. The warning "Unable to operate while driving." will be displayed if any attempts are made to perform these operations while driving.

- *The IVE-W585BT draws minimal current even when its power switch is turned off. If the switched power (ignition) lead of the IVE-W585BT is connected directly to the positive (+) post of the vehicle's battery, the battery may be discharged.*
An SPST (Single-Pole, Single-Throw) switch (sold separately) can be added to simplify this procedure. Then, you can simply place it in the OFF position when you leave the vehicle. Turn the SPST switch back ON before using the IVE-W585BT. For connecting the SPST switch, refer to the "Connection Diagram of SPST Switch (sold separately)" (page 85). If the power (ignition) lead is unswitched, it must be disconnected from the battery post should the vehicle be left unused for an extended period of time.

Discs Playable on This Unit

Playable Discs

The discs listed below can be played on this unit.

	Mark (logo)	Recorded Content	Disc size
DVD Video		Audio + Video	12 cm*
Music CD		Audio	12 cm
DivX®		Audio + Video	12 cm

* Two-layer DVD disc compatible

The formatted discs listed below can be played on this unit.

	CD-R/ CD-RW	DVD-R/ DVD-RW	DVD+R/ DVD+RW
CD Format	○		
MP3 Format ("mp3")	○	○	○
WMA Format ("wma")	○	○	○
AAC Format ("m4a")	○	○	○
DVD Video Format		○	○
DivX Format ("avi," "divx")	○	○	○

- Discs that are not finalised cannot be played back.

Discs that cannot be played

DVD-ROMs, DVD-RAMs, CD-ROMs (excluding MP3/WMA/AAC files), photo CDs, etc.

DualDisc

This unit is not compatible with DualDisc.

Using a DualDisc may cause unit malfunction, and may cause disc damage when the disc is inserted/ejected.

DVD region number (playable region number)

This DVD player will play back any disc whose region number is 2 (or All). DVDs with a region number other than those listed below, cannot be played on this DVD player.



Using compact discs (CD/CD-R/CD-RW)

If you use unspecified compact discs, correct performance cannot be guaranteed.

You can play CD-Rs (CD-Recordables)/CD-RWs (CD-ReWritables) which have been recorded only on audio devices. You can also play CD-Rs/CD-RWs containing MP3/WMA/AAC formatted audio files.

- Some of the following discs may not play on this unit:
Flawed discs, discs with fingerprints, discs exposed to extreme temperatures or sunlight (e.g., left in the car or this unit), discs recorded under unstable conditions, discs on which a recording failed or a re-recording was attempted, copy-protected CDs which do not conform to the audio CD industry standard.
- Use discs with MP3/WMA/AAC files written in a format compliant with this unit. For details, see pages 21 and 22.

To customers using CD-R/CD-RW

- If a CD-R/CD-RW cannot be played back, make sure the last recording session was closed (finalised).
- Finalise the CD-R/CD-RW if necessary, and attempt playback again.

Tips for making your own discs

The IVE-W585BT plays DVD Video, DivX[®], Audio CD and has a built in MP3/WMA/AAC decoder.

The following information is designed to help you create your own music CDs (either Audio CD or MP3/WMA/AAC encoded CD-R/RW files).

What is the difference between an Audio and MP3/WMA/AAC CD?

An Audio CD is the same format as the commercial CDs you buy in the store (also known as CD-DA). MP3 (MPEG Audio Layer 3)/WMA (Windows Media Audio)/AAC (Advanced Audio Coding) is a data file that uses a compression scheme to reduce the size of the music file*.

Multisession CD-R/RW:

Once a recording has been stopped, this is considered one session. If the disc is not closed (finalised), additional data may be added. Once this additional data has been recorded, this becomes a "multisession" CD.

- * If the first session on a disc containing both CD-DA data and MP3/WMA/AAC data is a CD-DA file, only CD-DA files will be played.

Properly formatted MP3/WMA/AAC Discs:

Use ISO9660 formatting to insure proper playback. You may use standard ISO naming Level 1 (8.3 DOS standard), Level 2 (32 characters) or Joliet (Windows or Macintosh long filenames) file naming conventions*.

- * Please consult the Owner's manual for additional information.

On handling compact discs (CD/CD-R/CD-RW)

- Do not touch the surface.
- Do not expose the disc to direct sunlight.
- Do not affix stickers or labels.
- Clean the disc when it is dusty.
- Make sure that the disc is smooth and flat.
- Do not use commercially available disc accessories.

Do not leave the disc in the car or the unit for a long time. Never expose the disc to direct sunlight.

Heat and humidity may damage the disc and you may not be able to play it again.

Using DVD-Rs/DVD-RWs/DVD+Rs/DVD+RWs

- This unit is compatible with discs recorded in the standard DVD-Video format.
- Note that discs not finalised (processed to enable to play on playback-only DVD players) cannot be played on this DVD player.
- Some discs may not play back, depending on the recording device and disc format.
- Discs or files utilising copy protection, may not be playable. Some recording systems may not properly format copied files to enable proper playback.
- In the following cases, the disc may not play on this unit: discs recorded by certain DVD recorders, certain irregular discs, flawed discs, dirty discs, when the pickup lens of this DVD player is dirty, or when moisture condensation has occurred inside the unit.
- Be sure to follow all cautions included with your DVD-Rs/DVD-RWs/DVD+Rs/DVD+RWs discs.
- Do not put stickers, seals, or tape on the label side of DVD-Rs/DVD-RWs/DVD+Rs/DVD+RWs.
- Compared to the regular discs, DVD-Rs/DVD-RWs/DVD+Rs/DVD+RWs are more affected by heat, moisture, and direct sunlight. If left in a car, etc., damage may occur and it might not play on this unit.
- The operable temperature range for disc playback is as follows:
DVD-R/DVD-RW: -25 ~ +70°C
DVD+R/DVD+RW: +5 ~ +55°C

Disc terminology

Title

If titles are programmed for the DVD, these are the largest units of division of the information recorded on the disc.

Chapter

Each Title may also be divided into smaller divisions, called chapters. These can be specific scenes or musical selections.

Protecting the USB connector

- Only an iPod/iPhone, USB memory or Mobile Phone can be connected to the USB connector on this unit. Correct performance using other USB products cannot be guaranteed.
- If the USB connector is used, be sure to use only the supplied connector cable with the unit. A USB hub is not supported.
- Depending on the connected USB memory device, the unit may not function or some functions may not be performed.
- The audio file format that can be played back on the unit is MP3/WMA/AAC.
- The video file format that can be played back on the unit is DivX®.
- Artist/song name, etc., can be displayed. Certain, special characters may not be correctly displayed.



CAUTION

Alpine accepts no responsibility for lost data, etc., even if data, etc., is lost while using this product.

On Handling USB Memory

- This unit can control a memory storage device that supports the USB Mass Storage Class (MSC) protocol. Playable audio file formats are MP3, WMA and AAC.
- USB memory function is not guaranteed. Use USB memory according to the terms of agreement. Read the USB memory Owner's Manual thoroughly.
- Avoid usage or storage in the following locations:
 - Anywhere in the car exposed to direct sunlight or high temperatures.
 - Anywhere the possibility of high humidity or corrosive substances are present.
- Fix the USB memory in a location where driver operation will not be hindered.
- USB memory may not function correctly at high or low temperature.
- Use only certified USB memory. Note that even certified USB memory, may not function correctly depending on its type or state.
- Depending on the settings of the USB memory type, memory state or encoding software, the unit may not play back or display properly.
- Files protected by DRM (Digital Rights Management), cannot be played back on this unit. These include AAC formatted files purchased from the iTunes Store and WMA or other files with some form of copyright protection.
- USB memory may take time to start playback. If there is a particular file other than audio in the USB memory, it may take considerable time before the file is played back or searched.
- The unit can play back "mp3," "wma" or "m4a" file extensions.
- Do not add the above extensions to a file other than audio data. This non-audio data will not be recognised. The resulting playback may contain noise that can damage speakers and/or amplifiers.
- It is recommended to back up important data on a personal computer.
- Do not remove the USB device while playback is in progress. Change SOURCE to something other than USB, then remove the USB device to prevent possible damage to its memory.

-
- *This item incorporates copy protection technology that is protected by U.S. patents and other intellectual property rights of Rovi Corporation. Reverse engineering and disassembly are prohibited.*
 - *Manufactured under licence from Dolby Laboratories. Dolby and the double-D symbol are trademarks of Dolby Laboratories.*
 - *Windows Media, and the Windows logo are trademarks, or registered trademarks of Microsoft Corporation in the United States and/or other countries.*
 - *iPhone, iPod, iPod classic, iPod nano, iPod touch, and iTunes are trademarks of Apple Inc., registered in the U.S. and other countries.*
 - *“Made for iPod,” and “Made for iPhone,” mean that an electronic accessory has been designed to connect specifically to iPod, or iPhone, respectively, and has been certified by the developer to meet Apple performance standards. Apple is not responsible for the operation of this device or its compliance with safety and regulatory standards. Please note that the use of this accessory with iPod, or iPhone may affect wireless performance.*
 - *DivX[®], DivX Certified[®] and associated logos are trademarks of Rovi Corporation or its subsidiaries and are used under license.*
 - *The Bluetooth[®] word mark and logos are registered trademarks owned by the Bluetooth SIG, Inc. and any use of such marks by Alpine Electronics, Inc. is under licence. Other trademarks and trade names are those of their respective owners.*
 - *“MPEG Layer-3 audio coding technology licenced from Fraunhofer IIS and Thomson.”*
 - *“Supply of this product only conveys a licence for private, non-commercial use and does not convey a licence nor imply any right to use this product in any commercial (i.e. revenue-generation) real time broadcasting (terrestrial, satellite, cable and/or any other media), broadcasting/streaming via internet, intranets and/or other networks or in other electronic content distribution systems, such as pay-audio or audio-on-demand applications. An independent licence for such use is required. For details, please visit <http://www.mp3licensing.com>”*
 - *Portions ©2013, Microsoft Corporation. All Rights Reserved.*
 - *Android is a trademark of Google Inc.*

Getting Started

Accessory List

• IVE-W585BT.....	1
• Power cable.....	1
• Flush head screw (M5x8).....	6
• Screw (M5x8).....	8
• CAMERA/AUX/PRE OUT cable	1
• USB extension cable	1
• Microphone.....	1
• Mounting sleeve	1
• Face plate.....	1
• Bracket key.....	2
• Rubber cap.....	1
• Hex bolt	1
• Owner's Manual	1set

Location of Controls

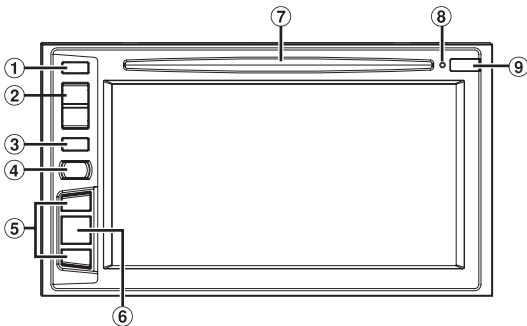

- 1 ▲ (Eject) button**
Ejects a disc.
- 2 ^/∨ (UP/DOWN) button**
Press to adjust the volume.
- 3 MUTE/🔇 button**
Press to activate /deactivate the mute mode.
Press and hold for at least 3 seconds to turn the power off.
- 4 📞 (Phone)/VOICE CTRL. button**
Recalls the Telephone Menu screen.
When a voice dial compatible hands-free phone is connected, press and hold for at least 3 seconds to switch to the Voice Dial screen.
- 5 ▶▶/⏪ button**
This action varies according to the Audio/Visual source.
(Track Up/Down, Fast reverse/Fast forward, etc.)
- 6 SOURCE/SOUND button**
Displays the Audio/Visual screen. If the Audio/Visual screen is already displayed, changes the source.
Press and hold for at least 3 seconds to activate the Quick Sound screen.
- 7 DISC Slot**
- 8 RESET switch**
The system of this unit is reset.
- 9 Remote Sensor**
Point the remote control transmitter towards the remote sensor within a range of 2 metres.

Optional Remote Control Interface Box

This unit is operable using the vehicle's secondary radio controls. An Alpine Remote Control Interface Box (optional) is required. For details, contact your Alpine dealer.

Controllable with Remote Control

This unit can be controlled with an optional Alpine remote control. For details, consult your Alpine dealer. Point the optional remote control transmitter at the remote control sensor.

About the button descriptions used in this Owner's Manual

The buttons found on the face of the unit are expressed in bold (e.g. **MUTE**). The buttons found on the touch-screen display are shown in bold within brackets, [] (e.g. [**X**]).

Turning Power On or Off

Some of this unit's functions cannot be performed while the vehicle is in motion. Be sure to stop your vehicle in a safe location and apply the parking brake, before attempting these operations.

1 Turn the ignition key to the ACC or ON position.

The system turns on.

- When turned on, the system displays the last mode screen that was displayed before the ignition key was turned off. For example, if the unit is in radio mode when ignition is turned off, it will remain in radio mode when ignition is turned back on.

2 Press and hold the **MUTE** button for at least 3 seconds to turn the power off.

- The unit can be turned on by pressing any button.
- The IVE-W585BT is a precision device. Careful handling of the unit should provide you with years of trouble-free operation.

Turning the System On

With the Alpine system, when the ignition key is turned to ACC or ON, the opening screen will be automatically displayed.

- 1 When the system is used for the first time, the language selection menu is displayed. There are 24 languages to choose from. Touch [▲] or [▼] to scroll the list, and then touch the desired language.



- You can also scroll through lists by touching the screen and sliding your finger up and down.
- 2 Touch [OK].
The radio screen is displayed.
- Some of this unit's functions cannot be performed while the vehicle is in motion. Be sure to stop your vehicle in a safe location and apply the parking brake before attempting these operations.

Initial System Start-Up

Be sure to press the RESET switch when using the unit for the first time, after changing the car battery, etc.

Press **RESET** with a ballpoint pen or similar pointed object.

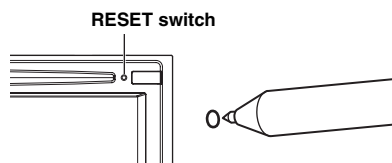

Inserting/Ejecting a Disc

Inserting the Disc

Insert the disc with the label side facing up.

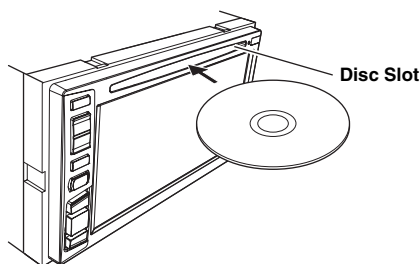

When you insert the disc up to certain point, it is automatically pulled into the unit. The unit starts to play the disc.

- Do not touch the surface of the disc directly with your fingers.
- Before inserting or removing the disc, always turn the ignition key to ACC or ON. You cannot remove or insert the disc with the ignition key turned to OFF.

Removing the Disc

Press ▲ (Eject) button.

When the disc has been ejected part way, take it out.

- If the disc cannot be ejected by pressing ▲, press and hold ▲ again for at least 5 seconds.

Adjusting the Volume

Adjust the volume by pressing ▼ or ▲.

Volume decreases/increases continuously by pressing and holding ▼ or ▲.

Volume: 0 - 35

Lowering Volume Quickly

Audio Mute function instantly lowers the volume level to 0.

- 1 Press **MUTE** button to activate the MUTE mode.
The audio level will be 0.
- 2 Pressing **MUTE** button again will bring the audio back to its previous level.

Top banner and Bottom banner Fade Out Setting

When “Top/Bottom Banner Fade Out” is set to [ON], the Top banner and Bottom banner on the Audio/Visual Playback screen fade out after 5 seconds if no operation is performed. To display the keys again, touch the middle of the screen.



- For details of how to set Top/Bottom Banner Fade Out, refer to “Setting Top banner and Bottom banner Display” (page 30).

Switching Sources

During audio/visual playback, press the **SOURCE/SOUND** button or touch a source button in the top banner to switch to the desired source.

Switching Sources Using the SOURCE/SOUND Button

During audio/visual playback, press the **SOURCE/SOUND** button repeatedly to switch to the desired source.

Radio → Disc*¹ → USB/iPod*¹ → Bluetooth Audio → AUX*² → AUX-2*³ → Radio...

- *¹ When no disc is inserted or no USB memory/iPod is connected, this option is not available.
- *² When AUX In is set to “iPod Video,” this option is not available.
- *³ When Secondary Name is set to “Off,” this option is not available.

- Notification List/Camera/Screen Off are not available.

Switching Sources Using the Top banner

Touch the source button for the Top banner at the top of the Audio/Visual Playback screen and select the desired source.

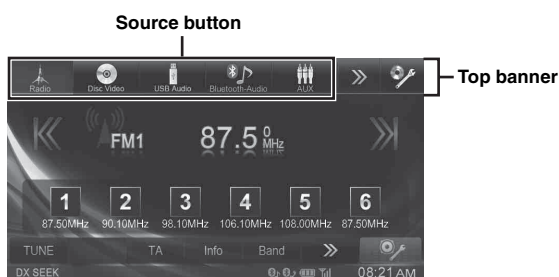

If the source button is hidden, touch <<< >>>.

Radio / Disc*¹ / USB/iPod*¹ / Bluetooth Audio / AUX*² / AUX-2*³ / Notification List*⁴ / Camera*⁵ / Screen Off

- *¹ When no disc is inserted or no USB memory/iPod is connected, this option is not available.
- *² When AUX In is set to “iPod Video,” this option is not available.
- *³ When Secondary Name is set to “Off,” this option is not available.
- *⁴ If the TuneIt App is not launched, this option is not available.
- *⁵ When Camera Select is set to “Off,” this option is not available.

Screen Off Function

This mode is useful if you feel the unit’s display is too bright at night. To cancel Screen Off mode, touch the screen.

- Screen Off mode is cancelled when the power or ACC is turned off.
- When the gear lever is shifted to the reverse (R) position while the rear camera is connected, the rear camera image is displayed.
- When a call is received while a BLUETOOTH device is connected, the incoming call screen is displayed.

About Sound Menu button

Touch [Sound Menu] icon on the screen to change the screen to the Sound Menu screen. Refer to “Sound Setup” (page 33).



[Sound Menu] icon

■ Sound Menu Screen



Touch Operation

You can operate the system by using the touch panel on the screen.

- *Be sure to touch the onscreen button lightly with the pad of your finger to protect the display.*
- *If you touch a button and there is no reaction, remove your finger from the display once, and try again.*
- *Onscreen buttons that cannot be operated appear dull in colour.*

Common onscreen buttons

- [↩]: Returns to the previous screen. Depending on the function, this button may cancel the operations performed on the screen.
- [X]: Closes the window.

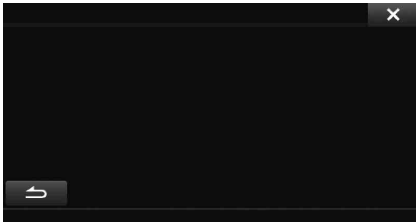

Selecting an Item in a List

To scroll through a list, perform the following operations.

Touch the screen and slide your finger up and down.

The screen will scroll along with your finger movement. Also, you can touch [▲] and [▼].



- *After touching the screen, move your finger away from the screen before dragging and that item will be selected.*

About the Indicator Display

The Indicator Bar at the bottom of the screen displays various types of information, like the current time.



- ① The display will differ depending on the source. For details, refer to the display example of each source.
- ② Lights up when connected to a BLUETOOTH compatible device.
 - : BLUETOOTH connection to audio device
 - : BLUETOOTH connection to Hands Free Phone. Blinks while reconnecting. Does not display when connection is set to OFF.
- ③ Indicates the battery level of the connected BLUETOOTH device.

Battery Level	No Battery	Level 1	Level 2	Level 3
Icon				

This may not be displayed depending on the connected BLUETOOTH device.

- ④ Indicates the signal strength level of the connected BLUETOOTH compatible device. Displayed when BLUETOOTH setting is ON.

0	1	2	3	No Service
				No Service

- ⑤ The clock display
You can switch between the 12 hour display and 24 hour display options.
For details on how to set the clock display, refer to "Time Setting" (page 29).

Radio

■ Display example for Radio main screen



- ① Band display
- ② Frequency display
- ③ Preset button
- ④ SEEK mode

Listening to the Radio

1 Touch [Radio] of Top banner.
The radio mode is activated and the display changes to the Radio mode screen.

2 Touch [Band] of Bottom banner to select the desired radio band.

Each touch changes the bands as follows:

FM1 → FM2 → FM3 → MW → LW → FM1

3 Touch [TUNE] to select the tuning mode.

DX SEEK Local SEEK MANUAL PTY SEEK*



* For details, refer "PTY (Programme Type) Tuning" (page 19).

• There are two modes you can select for auto tuning, DX and Local:

- DX (Distance) mode;
Both strong and weak stations will be tuned in.
- Local mode;
Only strong stations will be tuned in.
The initial setting is DX.

4 Touch [◀], [▶], [◀◀] or [▶▶] to change the radio frequency up or down respectively.

In manual mode, touch and hold to change the frequency continuously.

Presetting Stations Manually

- 1 Tune in a desired radio station you wish to store in the preset memory by manual or automatic seek tuning.**
- 2 Touch and hold any one of the preset buttons for at least 2 seconds.**
The selected station is stored.
- 3 Repeat the procedure to store up to 5 other stations onto the same band.**
To use this procedure for other bands, simply select the desired band and repeat the procedure.
A total of 30 stations can be stored in the preset memory (6 stations for each band; FM1, FM2, FM3, MW or LW).

- If a preset memory has already been set in the same preset number, it will be cleared and the new station will be memorised.

Presetting Stations Automatically

The tuner can automatically seek and store 6 strong stations in the selected band in ascending order of frequency.

After selecting the desired band, touch [A.Memo] of Bottom banner.

The tuner automatically seeks and stores 6 strong stations into the preset buttons in ascending order of frequency. When automatic storing has completed, the station stored in the preset 1 is selected.

- If no stations are stored, the tuner will return to the original station you were listening to before the automatic storing procedure began.
- You can cancel this process by touching [A.Memo] while the tuner is automatically seeking stations. Cancelling will return the tuner preset to the previous setting.

Tuning to Preset Stations

You can tune in the preset stations in memory on either band using its preset number.

- 1 Touch [Band] of Bottom banner repeatedly until the desired band is displayed.**
 - 2 Touch any one of the preset buttons that has a station stored to it.**
The preset station is received.
- Each time you press the ◀◀, ▶▶ buttons, you can also change the frequency registered into the preset buttons (1 through 6).

RDS

■ Display example for RDS Information



- ① Displays the Radio text (When a Radio station that transmits text messages)
- ② RDS indicator

Turning AF (Alternative Frequencies) On or Off

The RDS (Radio Data System) is a radio information system using the 57 kHz subcarrier of regular FM broadcasts. The RDS allows you to receive a variety of information such as traffic information, station names, and to automatically re-tune to a stronger transmitter that is broadcasting the same programme.

1 Touch [Radio] of Top banner.

The radio mode is activated and the display changes to the Radio mode screen.

2 Touch [AF] of Bottom banner to select the AF (Alternative Frequency) ON or OFF mode.

In AF ON mode, the "AF" Indicator lights up.

If [AF] is not displayed, touch [<<] in the bottom banner to display [AF].

- RDS mode is not be displayed for the MW or LW band.
- When the AF ON mode is selected, the unit automatically tunes to a strong signal station in the AF list.
- Use the AF OFF mode when automatic re-tuning is not required.

Tips

- If the unit receives the PTY31 (Emergency Broadcast) signal, the unit will show "Alarm" in the display only when PTY31 is set to on. For operation, refer to "Setting PTY31 (Emergency Broadcast) Reception" (page 43).
- The RDS digital data includes the following:

PI	Programme Identification
PS	Programme Service Name
AF	List of Alternative Frequencies
TP	Traffic Programme
TA	Traffic Announcement
PTY	Programme Type
EON	Enhanced Other Networks
- Refer to page 43 about "PI SEEK Setting," "Receiving RDS Regional (Local) Stations," "Switching the Display Language of PTY (Programme Type)" and "Setting PTY31 (Emergency Broadcast) Reception."

Receiving Traffic Information

Touch [TA] of Bottom banner to turn on the Traffic Information mode.

The TA indicator lights up.

When the traffic information station is tuned in, the TP indicator lights up.

Traffic information is heard only when it is being broadcast. If traffic information is not being broadcast, the unit is set in the standby mode.

When a traffic information broadcast begins, the unit automatically receives it and the display shows "T.Info."

When the traffic information broadcast is over, the unit will automatically be set to the standby mode.

- If the traffic information broadcast signal falls below a certain level, the unit remains in the receiving mode for 1 minute. If the signal remains below a certain level for over 70 seconds, "TA" will blink in the display.
- If you do not want to listen to traffic information being received, touch [TA] to skip that traffic information message. The T. Info mode will remain in the ON position to receive the next traffic information message.
- If the volume level is changed while receiving traffic information, the changed volume level will be memorised. When traffic information is received next time, the volume level will be automatically adjusted to the level memorised.
- If the Traffic Information mode is activated, the unit automatically switches to radio source (even if you select another source) and receives the traffic information broadcast. When the traffic information is finished, the unit returns to the previous source.

Receiving Traffic Information Manually

- 1 Touch [TA] of Bottom banner to turn on the Traffic Information mode.**
The TA indicator lights up.
 - 2 Touch [K] or [X].**
Seeks the broadcast station which is broadcasting the traffic information.
- You can seek the traffic information in DX Seek mode or Local Seek mode.

PTY (Programme Type) Tuning

- 1 Touch [PTY] of Bottom banner.**
The Select PTY list screen is displayed.
- 2 Touch the selected programme type to start searching for a station in the type.**
If no PTY station is found, "No PTY." will be displayed.
- 3 To select the next station in the PTY, touch [◀], [▶].**

Priority News

This function gives priority to the News programme. Whenever the News programme broadcasts, it will interrupt the programme you are currently listening to.

Touch [NEWS] of Bottom banner to activate the PRIORITY NEWS mode.

The "NEWS" indicator appears in the display. Touch [News] again to deactivate the Priority News mode and return to the programme you were previously listening to.

Displaying Radio Text

Text messages from a radio station can be displayed.

- 1 Tune in a radio station that transmits text messages.**
- 2 Touch [Info] in the bottom banner in FM radio mode repeatedly to switch to the desired display.**

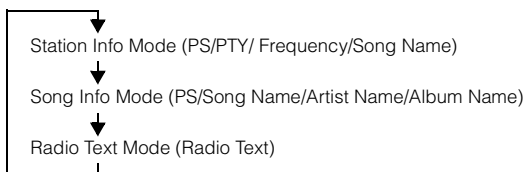

CD/MP3/WMA/AAC

■ Display example for MP3/WMA/AAC main screen



- ① Song title
- ② Artist title
- ③ Album title
- ④ Current song no./Total song no.
- ⑤ Playing time

- If there is no CD text, the message "No Text" appears.

Playback

1 Touch [Disc] of Top banner.

The display shows the Disc mode screen.

When a disc is inserted into the disc slot of this unit, with the label side facing up, the unit starts playback of the disc.

2 Touch [⏮] or [⏭] to select the desired track (file).

Returning to the beginning of the current track (file):

Touch [⏮].

Fast reverse :

Touch and hold [⏮].

Advancing to the beginning of the next track (file) :

Touch [⏭].

Fast forward :

Touch and hold [⏭].

- The ◀◀, ▶▶ buttons provide the same functions above.

3 To pause playback, touch [▶/||].

[▶/||] is displayed in the middle of the screen.

Touch [▶/||] again or touch [▶] in the middle of the screen to start playback.

- The IVE-W585BT can play back MP3/WMA/AAC files saved to CD or DVD. Use a format compliant with this unit. For further information about playing or storing MP3/WMA/AAC files, refer to pages 21 and 22 before using the unit.
- Any file protected by DRM (Digital Rights Management) copy protection, cannot be played back on this unit.
- If a disc contains both audio data and MP3/WMA/AAC data, this unit plays back only the audio data.
- The track display for CD audio data playback shows the track numbers recorded on the disc.
- If an MP3/WMA/AAC disc with many files and folders is played, it may take longer than normal to start playback.
- The playback time may not be correctly displayed when a VBR (Variable Bit Rate) recorded file is played back.

Repeat Play

Touch [↺] to repeatedly play back.

The tracks (files) will be played repeatedly.

The repeat mode switches every time the button is touched.

CD:

Repeat → (OFF) → Repeat



MP3/WMA/AAC:

Repeat → Repeat Folder* → (OFF) → Repeat



* Only files in a folder are repeatedly played back.

- If the Repeat Play mode is activated during M.I.X. playback, the M.I.X. mode will be cancelled.

M.I.X. (Random Play)

Touch [∞] of Bottom banner during playback.

The tracks (files) on the disc will be played back in a random sequence.

The M.I.X. mode switches every time [∞] is touched.

CD:

M.I.X. → (OFF) → M.I.X.



MP3/WMA/AAC:

M.I.X. Folder* → (OFF) → M.I.X. Folder*



* Only files in a folder are played back in random sequence.

- If the M.I.X. mode is activated during Repeat playback, the Repeat Play mode will be cancelled.
- If you select a track by using the search mode, the M.I.X. play mode will be cancelled.

M.I.X. ALL (Shuffle Songs) (Concerning MP3/WMA/AAC)

All files in the disc are played back in random sequence.

1 Touch [🔍 (Search)] of Bottom banner during playback.

2 Touch [Shuffle Songs].

The 🔄 indicator lights, and the songs in a folder are played back in random sequence. When all the songs in the target folder have been played, the next folder plays back.

To cancel M.I.X. play, touch [🔄].

Selecting Folders (Concerning MP3/WMA/AAC)

Touch [] or [] of Bottom banner to select the folder.

Searching from CD Text

1 Touch [] (**Search**) of Bottom banner during playback.

The CD text search screen is displayed.

2 Touch the selected track name.

The selected track will be played back.

- For details on how to scroll through the list, refer to “Selecting an Item in a List” (page 16).

File/Folder Name Search (Concerning MP3/WMA/AAC)

1 Touch [] (**Search**) of Bottom banner during playback.

The folder name list screen is displayed.

Folder Name Search mode

2 Touch [] in the desired folder.

The first file in the selected folder is played back.

File Name Search mode

2 Touch the desired folder name.

The File name of the selected folder is displayed.

3 Touch the desired file name.

The selected file is played back.

- To return to the previous hierarchy, touch [].
- For details on how to scroll through the list, refer to “Selecting an Item in a List” (page 16).
- After selecting a folder via a Folder name search, touch [] on the main screen to display the folder search screen.
- After selecting a file via a File name search, touch [] on the main screen to display the file search screen.

About MP3/WMA/AAC

CAUTION

Except for private use, duplicating audio data (including MP3/WMA/AAC data) or distributing, transferring, or copying it, whether for free or for a fee, without permission of the copyright holder is strictly prohibited by the Copyright Act and by international treaty.

What is MP3?

MP3, whose official name is “MPEG Audio Layer 3,” is a compression standard prescribed by the ISO, the International Standardisation Organisation and MPEG which is a joint activity institution of the IEC.

MP3 files contain compressed audio data. MP3 encoding is capable of compressing audio data at extremely high ratios, reducing the size of music files to as much as one-tenth their original size. This is achieved while still maintaining near CD quality. The MP3 format realises such high compression ratios by eliminating the sounds that are either inaudible to the human ear or masked by other sounds.

What is AAC?

AAC is the abbreviation for “Advanced Audio Coding,” and is a basic format of audio compression used by MPEG2 or MPEG4.

What is WMA?

WMA, or “Windows Media™ Audio,” is compressed audio data. WMA is similar to MP3 audio data.

Method for creating MP3/WMA/AAC files

Audio data is compressed using software with MP3/WMA/AAC codecs. For details on creating MP3/WMA/AAC files, refer to the user’s manual for that software.

MP3/WMA/AAC files that are playable on this device have the file extensions.

MP3: “mp3”

WMA: “wma” (ver. 7.x, 8.x, 9.x are supported)

AAC: “m4a”

WMA is not supported for the following files, Windows Media Audio Professional, Windows Media Audio 9 Voice or Windows Media Audio 9 Pro Lossless (Disc Media Only).

There are many different versions of the AAC format. Confirm that the software being used conforms to the acceptable formats listed above. It’s possible that the format may be unplayable even though the extension is valid. Playback of AAC files encoded by iTunes is supported.

Supported playback sampling rates and bit rates

MP3

Sampling rates: 8 kHz - 48 kHz (Disc/USB)
Bit rates: 8 kbps - 320 kbps (Disc/USB)

WMA

Sampling rates: 32 kHz - 48 kHz (Disc)
8 kHz - 48 kHz (USB)
Bit rates: 64 kbps - 256 kbps (Disc)
5 kbps - 384 kbps (USB)

AAC

Sampling rates: 16 kHz - 96 kHz (Disc)
8 kHz - 48 kHz (USB)
Bit rates: 32 kbps - 384 kbps (Disc)
48 kbps - 238 kbps (USB)

This device may not play back correctly depending on sampling rates.

ID3 tags/WMA tags

This device supports ID3 tag v1.0, v1.1, v2.2, v2.3, v2.4, and WMA tag Ver.1.x. If tag data is in an MP3/WMA/AAC file, this device can display the title (track title), artist name, and album name ID3 tag/WMA tag data (maximum 64 characters). The number of characters may be limited, or not correctly displayed, depending on the tag information.

Playing back MP3/WMA/AAC

MP3/WMA/AAC files are prepared, then written to a CD-R, CD-RW (DVD-R/DVD-RW/DVD+R/DVD+RW) using CD-R writing software and USB memory.

- Maximum numbers of playable files / folders
Disc: 2,000 files/200 folders (including Root Folder/DivX® file)
USB memory: 10,000 files/folders (including Root Folder/DivX® file)

Playback may not be performed if a disc exceeds the limitations described above.

If a file/folder name is long, the maximum possible number of files may decrease.

- Both Audio and Video files are counted if their formats are playable on this unit.

Media supported

The media that this device can play back are CD-ROMs, CD-Rs, CD-RWs, DVD-Rs, DVD-RWs, DVD+Rs, DVD+RWs and USB memory.

Corresponding File Systems

This device supports discs formatted with ISO9660 Level 1 or Level 2, UDF1.02 and UDF1.02(ISO Bridge).

Under the ISO9660 standard, there are some restrictions to remember.

The maximum nested folder depth is 8 (including the root directory). The number of characters for a folder/file name is limited.

Valid characters for folder/file names are letters A-Z (all caps), numbers 0-9, and '_' (underscore).

This device can play back discs in Joliet, Romeo, etc., and other standards that conform to ISO9660. However, sometimes the file names, folder names, etc., are not displayed correctly.

Formats supported

This device supports CD-ROM Mode1, CD-ROM XA Mode2(Form1&2), Mixed Mode CD and Multi-Session. This device cannot correctly play back discs recorded with Track At Once or packet writing.

Order of files

Files are played back in the order that the writing software writes them to the disc. Therefore, the playback order may not be what's expected. Verify the writing order in the software's documentation. The playback order of the folders and files is as follows. (The following numbers may differ from actually displayed numbers.)

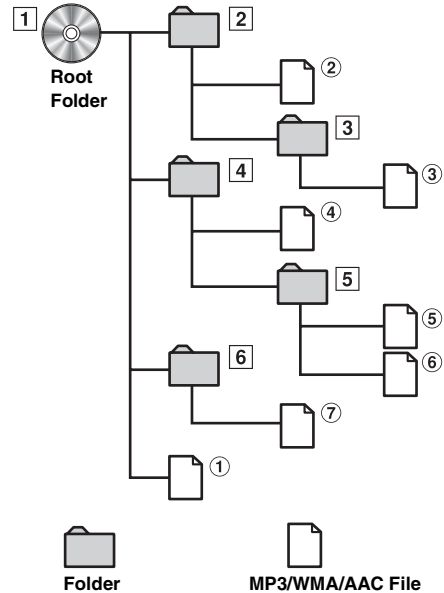

Terminology

Bit rate

This is the "sound" compression rate specified for encoding. The higher the bit rate, the higher the sound quality, but also the larger the files.

Sampling rate

This value shows how many times per second the data is sampled (recorded). For example, music CDs use a sampling rate of 44.1 kHz, so the sound is sampled (recorded) 44,100 times per second. The higher the sampling rate, the higher the sound quality, but also the larger the volume of data.

Encoding

Converting music CDs, WAVE (AIFF) files, and other sound files into the specified audio compression format.

Tag

Song information such as track titles, artist names, album names, etc., written into MP3/WMA/AAC files.

Root folder

The root folder (or root directory) is found at the top of the file system. The root folder contains all folders and files. It is created automatically for all burned discs.

DVD

■ Display example for DVD Video main screen

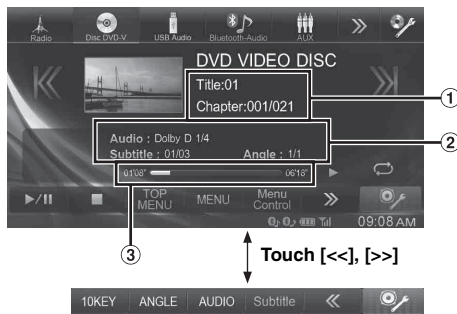

■ Display example for DivX® main screen

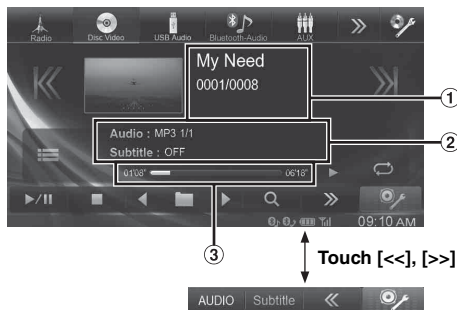

- ① Information display-1
DVD-Video:
Title name/Chapter No.
DivX®:
Title name/Current File No./Total File No. in Current Folder
- ② Information display-2
DVD-Video:
Audio signal output/Subtitle/Angle
DivX®:
Audio signal output/Subtitle
- ③ Playing time

Disc types that can be used for each heading are represented by the following marks.

DVD-V DVD Commercial Video discs (used for the distribution of movies, etc.) or a DVD-R/DVD-RW, DVD+R/DVD+RW recorded in a video mode can be used.

DivX CD-R/CD-RW/DVD-R/DVD-RW/DVD+R/DVD+RW discs that are recorded in the DivX® mode can be used.

The DVD operation screen display

Touch the screen while the DVD playback screen is displayed.

The DVD operation screen is displayed.



- The operation screen changes to the visual screen in the DVD mode for 5 seconds after an operation has been performed.
- If you try to activate the DVD while driving, the display will show the warning-Picture off for your safety.
- Some operations cannot be carried out depending on the disc or playback screen.

Playing a Disc **DVD-V** **DivX**

⚠ WARNING

It is dangerous for the driver to watch the DVD/TV/Video while driving the vehicle. The driver may be distracted from looking ahead and an accident could occur.

Install the IVE-W585BT correctly so that the driver cannot watch DVD/TV/Video unless the vehicle is stopped and the emergency brake is applied.

If the IVE-W585BT is not installed correctly, the driver will be able to watch the DVD/TV/Video while driving the vehicle and may be distracted from looking ahead causing an accident. The driver or other people could be severely injured.

⚠ Caution

- Not all functions will operate for every DVD. See the individual DVD's instructions for details on the features supported.
- Fingerprints on a disc may adversely affect playback. If a problem occurs, remove the disc and check for fingerprints on the playback side. Clean the disc if necessary.
- If you switch the power or Ignition key OFF or change sources during playback, playback will continue where you left off when you resume playback.
- If you try to perform an invalid operation (based on the type of disc being played), the following mark is displayed on the monitor screen: ⓧ

- **Play Position Memory Function**
Even if you turn power off or switch the Ignition key to OFF during playback or change the source, playback will continue from the point where playback stopped when the power is turned ON again.

Touch **[Disc]** of Top banner.

The display shows the Disc mode screen.

Or insert a disc with the label side facing up. The unit starts to play the disc.

- The reverse side of a double-sided DVD will not be played automatically.
Remove the disc, turn it over, and reinsert it.
- Refer also to "Disc Setting" (page 41).
- While reading a DivX[®] file, the fast-forwarding/fast-reversing and repeat functions, etc. cannot be used.
- A DivX[®] file that exceeds 4GB cannot be played back.

If a Menu Screen Appears

On DVD mode, menu screens may appear automatically. If this happens, perform the operation described below to start playback.

Direct Menu Operations DVD-V

Touch the DVD menu directly.

- Some operations cannot be performed depending on the disc.

Menu Operations DVD-V

1 Touch **[Key]**.

The menu operation mode will be displayed.

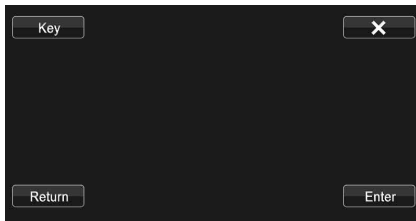

Touch **[←]** **[→]** to change the Key panel location from right to left or vice-versa.

Touch **[Return]** to return to the previous display.

2 Select a desired menu item by touching **[▼]**, **[▲]**, **[◀]** or **[▶]**.

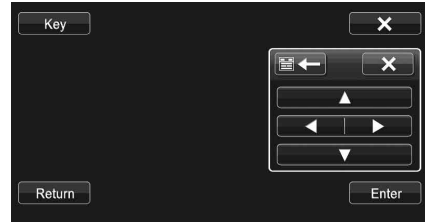

- Touching **[X]** in the operation panel returns to the screen in step 1.
- Touching **[Key]** displays the Numeric Keypad Input Mode screen.
For details of the Numeric Keypad Input Mode screen, refer to "Numeric Keypad Input Operations" (page 24).

3 Touch **[Enter]** to confirm the selected item.

Numeric Keypad Input Operations DVD-V

1 Touch **[10KEY]** of Bottom banner.

The numeric keypad input mode screen appears

if **[10KEY]** is not displayed, touch **[<<]** in the bottom banner to display **[10KEY]**.

2 Touch a desired number.

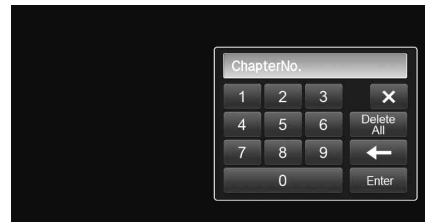

Touch **[←]** to delete an entered number.

Touch **[Delete All]** to delete all entered number.

3 Touch **[Enter]** on the numeric keypad mode screen to confirm your selection.

Touch **[X]** to hide the keypad display.

Displaying the Top Menu Screen DVD-V

When a DVD contains two or more titles, the top menu screen appears.

Touch **[TOP MENU]** of Bottom banner.

The top menu screen appears.

- To perform necessary operations, refer to "If a Menu Screen Appears" (page 24).

Displaying the Menu Screen DVD-V

With a DVD having two or more menus, a menu screen will appear for the programmes available, in addition to the main programmes.

Touch **[MENU]** of Bottom banner.

The Root menu screen appears.

- To perform necessary operations, refer to "If a Menu Screen Appears" (page 24).

Stopping Playback (PRE STOP)

DVD-V DivX

Touch the stop button during playback to stop playback. That position is stored in the memory.

1 Touch [■] during playback.

"Pre ■" indicator and [▶] in the middle of the screen are displayed.

2 Touch [▶/||] in the PRE STOP mode or touch [▶] in the middle of the screen.

Playback starts from the position at which it was stopped.

- For some discs, the position at which playback was stopped may not be accurate.

Stopping Playback

DVD-V DivX

Touch and hold [■] for at least 2 seconds during playback.

"■" indicator and [▶] in the middle of the screen are displayed.

- Playback starts from the beginning when [▶/||] or [▶] in the middle of the screen is touched while playback is stopped.

Fast-forwarding/Fast-reversing

DVD-V DivX

1 During playback, touch and hold [⏮] (Fast-reverse) or touch and hold [⏭] (Fast-forward).

Touch and hold for more than 1 second to forward/reverse at double speed.

Every time you touch [⏮]/[⏭] during fast-reverse/fast-forward, the speed changes as follows: 2x → 4x → 8x → 2x.

- For a DivX[®] file that does not contain index information, the fast forward and the reverse option is not available.
- The ⏮, ⏭ buttons provide the same functions above.

2 Touch [▶/||] to return to normal playback.

- No sound is played back during fast-forwarding/fast-reversing.
- On DVD mode, the menu screen may reappear during fast-forwarding/fast-reversing.
- This operation may not be possible on certain discs.

Finding the Beginnings of Chapters/Tracks/Files

DVD-V DivX

During playback, touch [⏮] or [⏭].

The chapter/track/file switches each time the button is touched, and playback of the selected chapter/track/file starts.

- ⏮: Touch this to start playback from the beginning of the current chapter, track or file.
- ⏭: Touch this to start playback from the beginning of the following chapter, track or file.

- Some DVDs do not have chapters.
- The ⏮, ⏭ buttons provide the same functions above.

Supplementary explanations

"Chapters" are divisions of movies or musical selections on DVDs.

Playing Still Frames (Pausing)

DVD-V DivX

1 During playback, Touch [▶/||] of Bottom banner.

2 Touch [▶/||] or [▶] in the middle of the screen to resume playback.

- No sound is played during the still frame mode.
- The image or sound may stop temporarily when playback starts from the pause mode. This is not a malfunction.

Slow Motion Playback

DVD-V

1 When [⏮] is touched and held while in the pause mode, the 1/16th speed slow motion playback mode is set.

Furthermore, when touched and held [⏮] again, the slow motion speed switches to 1/2 the normal speed.

- The ⏭ buttons provide the same functions above.

2 Touch [▶/||] of Bottom banner to play back.

- No sound is played during slow motion playback.
- 1/2, 1/16 are approximate speeds. The actual speed differs from disc to disc.
- You cannot execute reverse slow motion playback.

Selecting Folders DivX

Touch [**<■**] or [**■>**] of Bottom banner to select the folder.

- Touch [**<■**] to play from the first file of the previous folder.
Touch [**■>**] to play from the first file of the next folder.

Repeat Playback DVD-V DivX

Use this function to play the disc's titles, chapters or tracks, etc., repeatedly.

Touch [**↻**] of Bottom banner.

The repeat mode switches every time the button is touched.

DVD Video

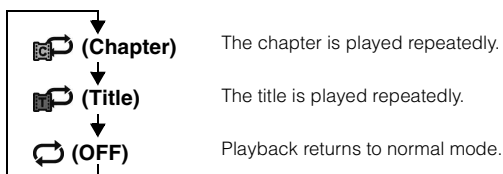

DivX®

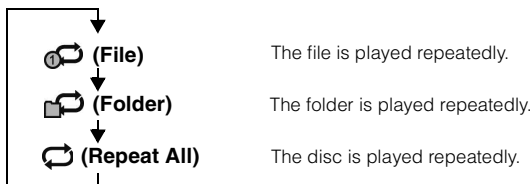

Searching by Title Number DVD-V

Use this function to easily find positions on the DVD using the DVD's titles. Perform operations while playback is stopped.

- 1 Touch [10Key] of Bottom banner.**
The numeric keypad input mode screen appears.
If [10KEY] is not displayed, touch [<<] in the bottom banner to display [10KEY].
 - For DVD Video, the numeric keypad can also be displayed by touching the Menu screen and then touching [Key] twice.
- 2 Enter a desired title by touching its number.**
See page 24 for operation of the numeric keypad.
- 3 Touch [Enter].**
Playback will start from the number selected.
- 4 Touch [X].**
 - This function cannot be used on discs on which no title numbers are recorded.
 - Some disc may not accept any operation.

Searching Directly by Chapter Number DVD-V

DVD-V

Use this function to easily move to the beginnings of the chapters on the disc. Perform operations during playback, during PRE-STOP or while playback is paused.

- 1 Touch [10Key] of Bottom banner.**
The numeric keypad input mode screen will appear.
If [10KEY] is not displayed, touch [<<] in the bottom banner to display [10KEY].
- 2 Touch and enter the chapter number you want to play.**
See page 24 for operation of the numeric keypad.
- 3 Touch [Enter] to confirm your selection.**
Playback will start from the selected chapter.
- 4 Touch [X].**
 - This function is not available for a disc on which chapters are not stored.

Searching for a Desired Video File DivX

DivX

You can select a video file from the list screen.

- 1 Touch [Q (Search)] of Bottom banner.**
The search mode is activated.
 - 2 Touch [Video].**
The folder list screen appears.
- Folder Name Search mode**
- 3 Touch [▶] in the desired folder.**
The first file in the selected folder is played back.

File Name Search mode

- 3 Touch the desired folder name.**
The File name of the selected folder is displayed.
- 4 Touch the desired file name.**
The selected file is played back.
 - To return to the previous hierarchy, touch [↶].
 - For details on how to scroll through the list, refer to "Selecting an Item in a List" (page 16).
 - After selecting a folder via a Folder name search, touch [≡] on the main screen to display the folder search screen.
 - After selecting a file via a File name search, touch [≡] on the main screen to display the file search screen.

Switching the Angle DVD-V

On DVDs in which scenes have been filmed from multiple angles, the angle can be switched during playback.

Touch **[ANGLE]** of Bottom banner.

The angle switches between the angles recorded on the disc every time the button is touched.

If [ANGL] is not displayed, touch [<<] or [>>] in the bottom banner to display [ANGL].

- *Some time may be required for the angle to change.*
- *Depending on the disc, the angle may switch in one of two ways.*
 - *Seamless: The angle switches smoothly.*
 - *Non-seamless: When the angle is switched, a still picture is displayed first, after which the angle switches.*

Switching the Audio Tracks DVD-V DivX

DVDs with multiplex audio or audio languages allow switching the sound during playback.

Touch **[AUDIO]** of Bottom banner.

The sound switches between the alternate audio tracks recorded on the disc every time the button is touched.

If [AUDIO] is not displayed, touch [<<] or [>>] in the bottom banner to display [AUDIO].

- *The alternate track selected becomes the default setting every time the power is turned on or the disc is replaced. If the disc does not include that track, the disc's default language is selected instead.*
- *Not all discs will allow changing the alternate audio tracks during playback. In these cases, select audio tracks from the DVDs menu.*
- *There may be a delay before the selected alternate track begins to play.*

Switching the Subtitles (Subtitle Language) DVD-V DivX

With DVDs on which multiple subtitle languages are recorded, the subtitle language can be switched during playback; moreover, subtitles can be hidden.

Touch **[Subtitle]** of Bottom banner.

Touching this button repeatedly selects sequentially the subtitle languages recorded on the disc, and then turns the subtitles OFF.

If [Subtitle] is not displayed, touch [<<] or [>>] in the bottom banner to display [Subtitle].

- *There may be a delay before the selected subtitle appears.*
- *Not all discs will allow changing the subtitles during playback. In these cases, select subtitles from the DVDs menu.*
- *The subtitle language selected becomes the default setting every time the power is turned on or the disc is replaced. If the disc does not include that language, the disc's default language is selected instead. However, the subtitle language may differ depending on the disc.*

About DivX®

DivX® is a codec (software) to compress moving images while maintaining image quality using a highly advanced compression ratio and operating speed.

- *Official DivX® Certified product*

ABOUT DIVX VIDEO: DivX® is a digital video format created by DivX, LLC, a subsidiary of Rovi Corporation. This is an official DivX Certified® device that plays DivX video. Visit divx.com for more information and software tools to convert your files into DivX videos.

ABOUT DIVX VIDEO-ON-DEMAND: This DivX Certified® device must be registered in order to play purchased DivX Video-on-Demand (VOD) movies. To obtain your registration code, locate the DivX VOD section in your device setup menu. Go to vod.divx.com for more information on how to complete your registration.

Media supported

The unit can play back CD-R/CD-RW/DVD-R/DVD-RW/DVD+R/DVD+RW discs and USB memory device that are recorded in the DivX® mode.

- *DivX® files stored in a USB memory device and protected by DRM (Digital Rights Management) cannot be played.*
- *Some DivX files stored in a USB memory cannot be operated/played.*

Corresponding extension

"avi," "divx"

Video Codec

DivX® versions 3, 4, 5, and 6 (versions 5 handle both interlaced and progressive)

Audio Codec

MPEG1 Layer2 (MP2)	32 to 384 kbps
MPEG1 Layer3 (MP3)	32 to 320 kbps
MPEG2 Layer2 (MP2)	8 to 160 kbps
MPEG2 Layer3 (MP3)	8 to 160 kbps
Dolby Digital	32 to 448 kbps

Image bit rate

"average 4 Mbps, Peak 8 Mbps"
Home Theater Profile supported

Setup

Setup Operation

Touch the [SETUP] icon on the Audio/Visual Playback screen to display the Setup main screen.

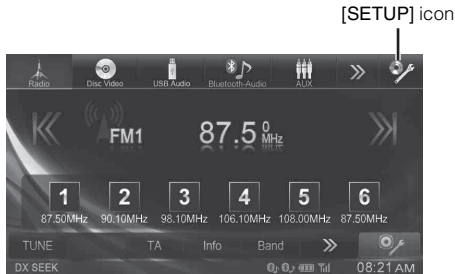

General Setup

General Setup Operation

The parking brake must be engaged to access the General mode screen. Attempting to access this screen while driving will display the warning-Unable to operate while driving.

The following steps 1 to 5 are common operations to each "Setting item" of General Setup. Refer to each section for details.

1 Touch [Setup] icon of Top banner.
The Setup main screen is displayed.

2 Touch [General].



The General Setup screen appears.

3 Select the desired item.

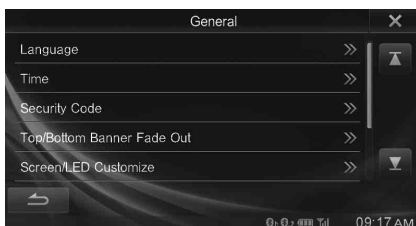

Setting items: Language / Time / Security Code / Top/Bottom Banner Fade Out / Screen/LED Customize / Visual / About / Demo mode

- Depending on the item, repeat step 3.

4 Touch [◀] or [▶] etc., to change its setting.

- When the pop-up window for setup is displayed, touch [X] to close the window after setting.

5 Touch [↶] to return to the previous screen.

- Immediately after changing the settings of General Setup (While the system is writing data automatically) do not turn the ignition key to OFF. Otherwise, the settings may not be changed.

Language Setting

[Language] is selected on the General setup menu in step 3. Refer to "General Setup Operation" (page 28).

Setting the Scroll

Scroll display is available if CD text, folder name, file name or tag information is entered.

Setting item: Auto Scroll

Setting contents: Off / On (Initial setting)

Off: Turns off the scroll mode.

On: Turns on the Auto scroll mode. Scroll display is repeated as long as the mode is turned on.

Format Settings

The character code to be used for tag text information displayed on the screen can be selected from 7 character codes.

Setting item: Format Sel.

Setting contents: Latin-1 / Latin-9 (Initial setting) / Russian / Chinese / Thai / Arabic / Hebrew

Latin-1: ISO 8859-1

Latin-9: ISO 8859-15

Russian: ISO 8859-5

Chinese: GB18030

Thai: CP874

Arabic: CP1256

Hebrew: CP1255

Setting the Menu Language

The Setup menu, feedback information, etc. for this unit can be changed to appear in the selected language.

Setting item: Language Sel.

Setting contents: English / Spanish / French / Italian / German / Portuguese / Swedish / Finnish / Russian / Dutch / Norwegian / Thai / Arabic / Chinese / Czech / Danish / Greek / Hungarian / Polish / Slovak / Turkish / Hebrew / Bahasa Indonesia / Bahasa Malay

- Touch [OK] to confirm the language and display the screen in the specified language.

Time Setting

[Time] is selected on the General setup menu in step 3. Refer to “General Setup Operation” (page 28).

Clock Display Setting

The clock indication on the monitor display is turned on or off respectively.

Setting item: Clock Display

Setting contents: Off / Type A / Type B

- Off: Not displayed
- Type A: The clock indication is displayed in the upper right corner of the screen when the Top banner fades out.
- Type B: The clock indication is always displayed in the bottom right corner of the screen.

Setting the Clock Mode

You can select the clock display type, 12-hour or 24-hour, depending on your preference.

Setting item: Clock Mode

Setting contents: 12h / 24h (Initial setting)

- When the Clock Display setting is set to “Off,” setting is not available.

Setting the Time (Hour)

Setting item: Hour

Setting contents: AM12 - AM11 - PM12 - PM11 (12h) or 00 - 23 (24h)

- Touch and hold [-] or [+] to run through a change sequence automatically.
- When the Clock Display setting is set to “Off,” setting is not available.

Setting the Time (Minute)

Setting item: Minute

Setting contents: 00 - 59

- Touch and hold [-] or [+] to run through a change sequence automatically.
- When the Clock Display setting is set to “Off,” setting is not available.

Security Code Setting

[Security Code] is selected on the General setup menu in step 3. Refer to “General Setup Operation” (page 28).

Setting Security code

You can set the system to be unusable without entering a password. When you turn this setting to “On” and set a password, password input is required when the system is connected to a battery and turned on for the first time.

Setting item: Security Code

Setting contents: Off (Initial setting) / On

Setting the password

1 Touch [◀] or [▶] of “Security Code” to set to “On.”

2 After the confirmation message appears, touch [OK].

The password setting screen is displayed.

3 Enter a password, then touch [OK].

- Enter the 6-digit number.
- Input numbers are displayed as “*.”

4 Enter the same password again, then touch [OK].

The password is set and the system returns to the previous screen.

- If you forget a registered password, you can not use this unit. In this case, service will be required.

Clearing the password

1 Touch [◀] or [▶] of “Security Code” to set to “Off.”

The password setting screen is displayed.

2 Enter the password you have set, then touch [OK].

The password is cleared and the system returns to the previous screen.

- Input numbers are displayed as “*.”

Setting Top banner and Bottom banner Display

[**Top/Bottom Banner Fade Out**] is selected on the General setup menu in step 3. Refer to “General Setup Operation” (page 28).

You can configure the display setting for the Top banner and Bottom banner for the audio/visual source.

Setting item: Top/Bottom Banner Fade Out

Setting contents: Off (Initial setting) / Top / Top and Bottom

- Off: Always displayed
- Top: Top banner will fade out after 5 seconds if no operations are performed.
- Top and Bottom: Top banner and Bottom banner will fade out after 5 seconds if no operations are performed.

Screen/LED Customize

[**Screen/LED Customize**] is selected on the General setup menu in step 3. Refer to “General Setup Operation” (page 28).

Setting the Brightness of the Backlighting

The illumination control adjusts the brightness of the backlighting based on the car ambient lighting for easier viewing.

Setting item: Dimmer

Setting contents: Auto (Initial setting) / On / Off

- Auto: Adjust the brightness of the background illumination of the monitor automatically to the brightness of the car interior.
 - On: Keep the background illumination of the monitor dark.
 - Off: Deactivate Auto Dimmer mode to keep the background illumination of the monitor bright.
- When “Auto” or “On” is set, the setting is also applied for the button lighting in “Adjusting the Dimmer of Button Lighting at Night” (page 30).

Adjusting the Minimum Level of Backlight

You can adjust the brightness of the backlight. This function could be used, for instance, to change the screen brightness while travelling at night.

Setting item: Screen Dimmer Level

Setting content: -15 to +15 (Initial setting: 0)

You can adjust the level between MIN (-15) and MAX (+15). When it reaches the minimum or maximum point, the display shows “MIN” or “MAX” respectively.

Adjusting the Dimmer of Button Lighting at Night

You can adjust the brightness of the button lighting at night with the dimmer.

Setting item: Key Illumination Level

Setting level: -2 to +2 (Initial setting: 0)

Switching the Display Colour and Wallpaper Image (Background)

You can change the Display Colour or Wallpaper Image.

Copy the desired image file from a USB memory device to use on this device.

- Copiable image files
 - PNG (.png)/JPEG (.jpg)
 - Max Resolution=4000x4000 pixel

1 Touch [Background Customize].

■ Display example for Background Setting main screen

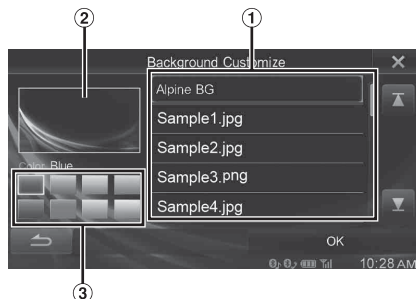

- ① Wallpaper File List in USB memory
 - Built in Wallpaper Image File is “Alpine BG.”
- ② Preview of selected file
- ③ Colour select switch

Switching the Display Colour

Setting Colour: Blue (Initial setting) / Light Blue / Turquoise / Green / Red / Amber / Dark Yellow / White

2 Touch the desired colour select switch.

The Display Colour is changed. The changed Display Colour will be reflected even if [OK] in the lower right of the screen is not touched.

Switching the Wallpaper Image (Background)

2 Select the desired file from the Wallpaper File List.

The selected file is previewed.

3 Touch [OK].

The previewed image file is set as the Wallpaper Image.

- You cannot change the colour of the Wallpaper Image copied from a USB memory device.

Visual Setting

[Visual] is selected on the General setup menu in step 3. Refer to "General Setup Operation" (page 28).

1 Touch the desired item.



- "Current Source" can be setting while a video is playing.
- "Camera" can be set when "Camera Select" is set to "Rear."

2 Touch [>>] of the desired item.

Setting item: Current Source (Video Media) / Camera

Setting contents: Display Mode* / Brightness / Color / Contrast

* Only "Current Source (Video Media)" can be set.

3 Touch [<] or [>] to change its setting.

4 Touch [↶] to return to the previous screen.

- Immediately after changing the settings of Display Setup (While the system is writing data automatically) do not turn the ignition key to OFF. Otherwise, the settings may not be changed.

Switching Display Modes

Setting item: Display Mode

Setting contents: FULL (Initial setting) / NORMAL



In FULL mode, the monitor displays a normal picture wider to fit in a wide-screen monitor.



In NORMAL mode, the monitor displays a normal picture at the centre of the screen with a vertical black band at each side.

Adjusting Brightness

Setting item: Brightness

Setting content: -15 to +15 (Initial setting: 0)

You can adjust the brightness between MIN (-15) and MAX (+15). When it reaches the minimum or maximum point, the display shows "MIN" or "MAX" respectively.

Adjusting Colour of Picture

Setting item: Color

Setting content: -15 to +15 (Initial setting: 0)

You can adjust the colour between MIN (-15) and MAX (+15). When it reaches the minimum or maximum point, the display shows "MIN" or "MAX" respectively.

Adjusting Image Contrast

Setting item: Contrast

Setting content: -15 to +15 (Initial setting: 0)

You can adjust the contrast between LOW (-15) and HIGH (+15). When it reaches the minimum or maximum point, the display shows "LOW" or "HIGH" respectively.

About IVE-W585BT

[About] is selected on the General setup menu in step 3. Refer to “General Setup Operation” (page 28).

Displaying the Product Information

You can view the version information of this product. Make note of this information and refer to it whenever you contact Alpine Tech Support or an Alpine-authorized dealer.

Setting item: *Version Info*

Contents: *Serial No. / Firmware Version*

Checking the DivX® Registration

This unit will display the registration code required to play a DivX® VOD (Video On Demand), or you can also display the deregistration code.

Setting item: *Warranty / Copyright Info.*

Displaying the Registration Code

- 1 Touch **[Warranty/Copyright Info.]**.
- 2 Touch **[DivX(R) VOD]**.
- 3 Touch **[Registration]**.
The registration code is displayed on the screen.
- 4 Touch **[OK]**.

Displaying the Deregistration Code

- 1 Touch **[Warranty/Copyright Info.]**.
 - 2 Touch **[DivX(R) VOD]**.
 - 3 Touch **[Deregistration]**.
The confirmation dialog screen appears.
 - 4 Touch **[OK]**.
The deregistration code is displayed on the screen.
- *When you have finished, touch [Cancel]. If you want to continue and display a new registration code, touch [OK], check the registration code, and then touch [OK] again.*

Initialising the System

You can initialise all data, to restore the factory settings. Remove the CD/DVD disc, etc. from the system before operation

Setting item: *Restore Factory Setting*

- 1 Touch **[Restore Factory Setting]**.
 - 2 **After the confirmation message appears, touch [OK]**.
The confirmation screen appears again.
 - 3 Touch **[OK]**.
The system starts initialisation.
- *Do not turn on/off the power or change the ignition key position until system restart is completed.*
 - *If you perform this setting, the On/Off setting of Security Code (page 29) is not initialised.*

Demonstration Setup

[Demo mode] is selected on the General setup menu in step 3. Refer to “General Setup Operation” (page 28).

Setting Demo mode to Off/On

This unit has a Demonstration feature for the display. When you install and use the unit for the first time, the unit will enter demo mode automatically. To quit demo mode, set Demo mode to Off.

Setting item: *Demo mode*

Setting contents: *Off / On (Initial setting)*

- *If you perform an operation during the Demo mode, the demonstration is temporarily stopped.*

Sound Setup

Sound Setup Operation

The parking brake must be engaged to access the Setup screen. Attempting to access this screen while driving will display the warning-Unable to operate while driving.

The following steps 1 to 5 are common operations to each "Setting item" of Sound Setup. Refer to each section for details.

1 Touch [Setup] icon of Top banner.
The Setup main screen is displayed.

2 Touch [Sound Menu].



The Sound Menu screen appears.

3 Select the desired item.



Setting items: Car Specific Sound Setup* / Media Xpander* / EQ Presets* / Quick Sound / TCR (Time Correction) / X-OVER* / Parametric EQ* / Other / Defeat*

* When BASS ENGINE SQ of Quick Sound Setup is set to "ON," this setting cannot be selected.

4 Touch [◀] or [▶] etc., to change its setting.
• When the pop-up window for setup is displayed, touch [X] to close the window after setting.

5 Touch [↶] to return to the previous screen.

• Immediately after changing the Sound Setup (while the system is writing data automatically) do not turn the ignition key to OFF. Otherwise, the settings may not be changed.

Car Specific Sound Setup

[Car Specific Sound Setup] is selected in the Sound setup menu in step 3. Refer to "Sound Setup Operation" (page 33).

You can set and reproduce the best audio environment for the environment in your car.

1 Touch the relevant Vehicle type.



2 Touch the position of the driver's seat.

3 Touch the size of the front speaker.

4 Select whether or not there is a tweeter.

5 Select the installation position of the rear speaker.
If you select "No rear speaker," you cannot adjust the rear speaker in Fader/Time Correction/X-OVER in sound setup.

6 Select whether or not there is a subwoofer.
If you select "No," you cannot adjust the subwoofer level/subwoofer phase in sound setup.

7 Select the material of the car seats.
The settings confirmation screen is displayed.

• If the car seats are made of both leather and fabric, select [Half leather].

8 Check the settings and touch [OK].



- If Preset3 was already saved for Time Correction/X-OVER/ Parametric EQ, the data will be overwritten.
- The Car Specific Sound settings are reflected in the following Audio Setup items:
 - Adjusting the Parametric Equalizer Curve (Parametric EQ)
 - Adjusting the Time Correction (TCR)
 - Adjusting the Crossover Settings (X-OVER)
- The Equalizer Presets (EQ Presets) settings are FLAT.

Setting the MX (Media Xpander)

[Media Xpander] is selected on the Sound setup menu in step 3. Refer to “Sound Setup Operation” (page 33).

When the currently playing source is AM radio band (MW/LW), this option is not available.

MX (Media Xpander) makes vocals or instruments sound distinct regardless of the music source. The FM radio, CD, USB memory and iPod/iPhone, will be able to reproduce the music clearly even in cars with a lot of road noise.

Setting item: Media Xpander

- 1 Touch [ON] of “ALL MX OFF/ON” in the MX setup screen.



- 2 Touch any of [Off] [1] [2] [3].

Media	Level			
	OFF	1	2	3
Radio (FM)	Off	[1]	[2]	[3]
DVD	Off	Movie	Movie	DVD Music
CD	Off	[1]	[2]	[3]
Compressed Media (CMPM)	Off	[1]	[2]	[3]
AUX	Off	CMPM	Movie	Music

- The MX setting can be performed only when a source is currently selected.
- MP3/WMA/AAC/iPod/USB Audio/DivX®/Bluetooth Audio correspond to MX Compressed Media.

MX FM

The medium to high frequencies become more clear, and produces well balanced sound in all the bands.

MX DVD

(Movie)

The dialog portion of the video is reproduced more clearly

(DVD Music)

This disc contains a large quantity of data such as music clip. MX uses this data to reproduce the sound accurately.

MX CD

CD mode processes a large quantity of data. This data is used to reproduce the sound cleanly by making use of the data quantity.

MX Compressed Media

This corrects information that was omitted at the time of compression. This reproduces a well-balanced sound close to the original.

MX AUX

Choose the MX mode (CMPM, Movie, or Music) that corresponds to the media connected.

- To cancel MX mode for all music source, set MX to “Off” in step 1.
- Each music source, such as FM radio, CD, and MP3/WMA/AAC can have its own MX setting.

Equalizer Presets (EQ Presets)

[EQ Presets] is selected on the Sound setup menu in step 3. Refer to “Sound Setup Operation” (page 33).

10 typical equalizer settings are preset at the factory for a variety of musical source material.

Setting item: EQ Presets

Setting contents: FLAT (Initial setting) / POP / ROCK / NEWS / JAZZ / ELECTRONICA/DANCE / HIP HOP / EASY LISTENING / COUNTRY / CLASSICAL

- Only one type can be set to ON.
- When EQ Presets is set, the interlinked Parametric EQ settings are also changed. We recommend storing Parametric EQ settings in the Preset in advance.
- The EQ Presets setting can be configured when Defeat is “Off.”

Quick Sound Setup

[Quick Sound] is selected on the Sound setup menu in step 3. Refer to “Sound Setup Operation” (page 33).

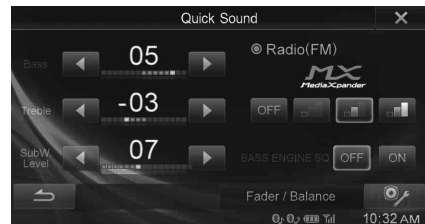

Adjusting Bass Level/Treble Level

Setting item: Bass/Treble

Setting contents: -7 to +7 (Initial setting: 0)

- When BASS ENGINE SQ is set to “ON,” this setting cannot be set.
- Adjustment cannot be performed when Defeat is set to “On.”
- The Bass adjusted setting value is interlinked with Band2 of Parametric EQ, and the Treble adjusted setting value is interlinked with Band8.

Adjusting the Subwoofer Level

You can set the Subwoofer level when a Subwoofer is connected.

Setting item: SubW. Level

Setting contents: 0 to 15 (Initial setting: 0)

- If the Subwoofer setting is “Off,” the setting cannot be set.
- When BASS ENGINE SQ is set to “ON,” this setting cannot be set.

Setting the MX (Media Xpander)

For details on Setting the MX (Media Xpander), refer to page 34.

- When “ALL MX OFF” is set, you cannot adjust MX level on the Quick Sound screen.
- When BASS ENGINE SQ is set to “ON,” the setting is not available.

Setting the BASS ENGINE SQ

Selecting BASS ENGINE Type in BASS ENGINE SQ optimizes sound in all zones of the vehicle. Select the desired BASS ENGINE Type according to the music genre and mood for well-balanced and effective bass sound.

Touch BASS ENGINE SQ [ON].

The BASS ENGINE SQ select screen is displayed.

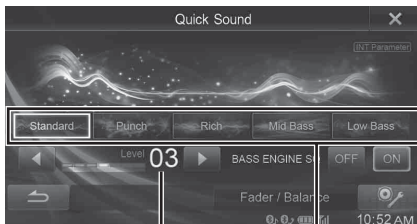

BASS ENGINE Level

BASS ENGINE Type

- When BASS ENGINE SQ is set to “ON,” Car Specific Sound Setup/ Parametric EQ/Media Xpander/EQ Presets/X-Over cannot be operated as they are adjusted automatically. Default is set to “Off.”

Setting the BASS ENGINE Type

You can set your favorite BASS ENGINE type.

Setting contents: Standard (Initial setting) / Punch / Rich / Mid Bass / Low Bass

- Standard:** Natural low-pitched sound located in front of front seats.
- Punch:** Punched bass sound, massive, with a feeling of speed.
- Rich:** You can feel wrapped with rich Low-pitched sound by arranging super-low-pass, low-pass, and mid lowpass, with sufficient balance.
- Mid Bass:** Emphasizes the presence of an upper bass. Reproduces low-pass with a sense of speed.
- Low Bass:** Super-low-pass presence and a low-pitched sound which is oriented downwards with deep feeling.

- The function is disabled when BASS ENGINE SQ is set to “OFF.”

Adjusting the BASS ENGINE Level

You can adjust the BASS ENGINE Level.

Setting item: Level

Setting contents: 0 to 6 (Initial setting: 3)

- The function is disabled when BASS ENGINE SQ is set to “OFF.”
- The Level 0 of the BASS ENGINE SQ is common to all the types.

About Setup when the external power amplifier is connected

In order to optimize the BASS ENGINE SQ, we recommend the following procedure to set up the power amplifier.

After setting up, the BASS ENGINE Level will be adjusted according to the music.

- 1) Set GAIN of the power amplifier to “MIN.”
- 2) Set the Crossover Mode Sector switch to “OFF.”
 - If the switch has no “OFF” position, set as near as possible to full range.
- 3) Set the BASS ENGINE SQ of this unit to “ON,” and the BASS ENGINE Level to “3.”
- 4) Play a song of the genre you frequently listen to, and adjust GAIN of the power amplifier.

Adjusting the Fader/Balance

1 Touch [Fader/Balance].

The Fader/Balance setting screen is displayed.



Image area

2 Touch the desired point within the image area. Or touch [▲][▼][◀][▶].

Fader: F15 to R15

Balance: L15 to R15

- * Touch  to return the Fader/Balance value to “00” (centre).

Adjusting the Time Correction (TCR)

[TCR] is selected on the Sound setup menu in step 3. Refer to “Sound Setup Operation” (page 33).

Before performing the following procedures, refer to “About Time Correction” (page 38).

Setting item: Time Correction

1 Touch [ms] or [cm] to select mode for making adjustments.

Each time you touch, the onscreen button and correction mode changes.

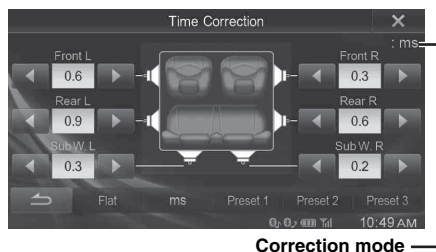

ms: Adjust time.

cm: Adjust listening position and distance from each speaker.

2 Touch [◀] or [▶] for each speaker to adjust the time or distance.

0.0msec to 9.9msec (0.1msec/step)

0.0cm to 336.6cm (3.4cm/step)

All speaker setting values are adjustable in the range of 15ms or 510cm.

3 To store the adjusted setting value, touch and hold [Preset1], [Preset2], or [Preset3] for at least 2 seconds.

- Touch [Flat] to set all values to 0.0.
- If the Rear Speaker setting is “Off,” the Rear Speaker setting cannot be edited (Refer to page 38).
- If the Subwoofer setting is “Off,” the Subwoofer setting cannot be edited (Refer to page 38).

Calling the Time Correction Value

Calling the pre-set time correction value.

Touch [Preset1], [Preset2], or [Preset3] on the time correction screen.

The setting stored in the Preset will be recalled.

Adjusting the Crossover Settings (X-OVER)

[X-OVER] is selected on the Sound setup menu in step 3. Refer to “Sound Setup Operation” (page 33).

Before performing the following procedures, refer to “About the Crossover” (page 40).

Setting item: X-OVER

1 Touch [Channel] to select the channel.

Each time you touch, the channel switches.

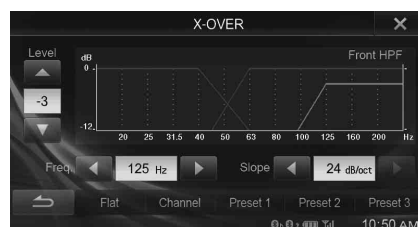

- The channel being adjusted is displayed in red.

→ Front HPF → Rear HPF → SubW. LPF

2 Adjust the crossover to your preference.

Selecting the Cut-Off Frequency

Touch [◀] or [▶] of “Freq.”, then select the cut-off frequency.

Setting contents: 20 / 25 / 31.5 / 40 / 50 / 63 / 80 (Initial setting) / 100 / 125 / 160 / 200 Hz

Adjusting the Slope

Touch [◀] or [▶] of “Slope”, then adjust the HPF or LPF slope.

Setting contents: 0 (Initial setting) / 6 / 12 / 18 / 24 dB/oct

Adjusting the Level

Touch [▼] or [▲] of “Level”, then adjust the HPF or LPF level.

Setting contents: -12 to 0 dB (Initial setting: 0)

3 Repeat steps 1 to 2 to make adjustment to the other channels.

4 To store the adjusted setting value, touch and hold [Preset1], [Preset2], or [Preset3] for at least 2 seconds.

- Touch [Flat] to initialise all values.
- If the Rear Speaker setting is “Off,” the Rear Speaker setting cannot be edited (Refer to page 38).
- If the Subwoofer setting is “Off,” the Subwoofer setting cannot be edited (Refer to page 38).
- While adjusting the X-OVER you should consider the frequency response of the connected speakers.

Calling the X-OVER adjusted value

Calling the pre-set X-OVER adjusted value.

Touch [Preset1], [Preset2], or [Preset3] on the X-OVER screen.

The setting stored in the Preset will be recalled.

Adjusting the Parametric Equalizer Curve (Parametric EQ)

[Parametric EQ] is selected on the Sound setup menu in step 3. Refer to "Sound Setup Operation" (page 33).

You can modify the Equalizer settings to create a response curve more appealing to your personal taste.

Setting item: Parametric EQ

1 Adjust the Parametric EQ to your preference.

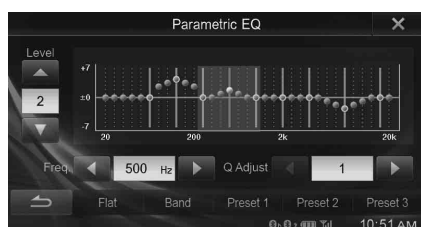

Adjusting the Band

Touch [Band] to select the band to be adjusted.

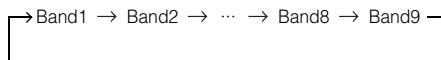

- You can select a band directly by touching the screen.

Adjusting the Frequency

Touch [◀] or [▶] of "Freq." to adjust the frequency of the selected band.

Adjustable frequency bands: 20 Hz to 20 kHz (in 1/3 octave steps)

- Band1: 20 Hz~100 Hz (63 Hz)
- Band2: 63 Hz~315 Hz (125 Hz)
- Band3: 125 Hz~500Hz (250 Hz)
- Band4: 250 Hz~1 kHz (500Hz)
- Band5: 500 Hz~2 kHz (1 kHz)
- Band6: 1 kHz~4 kHz (2 kHz)
- Band7: 2 kHz~7.2 kHz (4 kHz)
- Band8: 5.8 kHz~12 kHz (8 kHz)
- Band9: 9 kHz~20 kHz (16 kHz)

Adjusting the Level

Touch [▼] or [▲] of "Level" to adjust the level of selected band.

Setting contents: -7 to +7 (Initial setting: 0)

Setting the Bandwidth

Touch [◀] or [▶] of "Q Adjust" to select the bandwidth.

Setting contents: 1 (Initial setting) / 2 / 3

2 To adjust another band, repeat step 1, and adjust all bands.

3 To store the adjusted setting value, touch and hold [Preset1], [Preset2], or [Preset3] for at least 2 seconds.

- Settings exceeding the frequency of adjacent bands are not available.
- While adjusting the Parametric EQ, you should consider the frequency response of the connected speakers.
- When the Parametric EQ is adjusted, the adjustment for EQ Presets becomes ineffective.
- When EQ Presets is set, the interlinked Parametric EQ settings are also changed. Band2 of Parametric EQ is also interlinked with the Bass adjusted setting value, and Band8 is interlinked with the Treble adjusted setting value. We recommend storing Parametric EQ settings in the Preset in advance.
- Touch [Flat] to initialise all values.
- The Parametric EQ setting can be configured when Defeat is "Off"

Calling the Parametric EQ adjusted value

Calling the pre-set Parametric EQ adjusted value.

Touch [Preset1], [Preset2], or [Preset3] on the Parametric EQ screen.

The setting stored in the Preset will be recalled.

Other Setting

[Other] is selected on the Sound setup menu in step 3. Refer to “Sound Setup Operation” (page 33).

Volume Setting

You can change the volume of the sound heard when a button is touched.

Setting item: Volume → Key Sound Feedback

Setting contents: 0 to 7 (Initial setting: 5)

Setting the Volume for Each Source

Setting item: Source Volume Setup → Radio / DVD / CD / Compress Media / iPod Music / iPod Video / AUX / Bluetooth Audio

Setting contents: -14 to +14 (Initial setting: 0)

- Settable source differ depending on the connected device and settings.

Rear Speaker Setting

You can set the rear speaker output to “Off.”

Setting item: Rear Speaker

Setting contents: On (Initial setting) / Off

Turning Subwoofer ON/OFF

If an optional subwoofer is connected to the unit, make the following setting.

Setting item: Subwoofer

Setting contents: On / Off (Initial setting)

Setting the Subwoofer Phase

The subwoofer output phase is toggled Subwoofer Normal (0°) or Subwoofer Reverse (180°).

Setting item: Subwoofer Phase

Setting contents: 0° / 180° (Initial setting: 0°)

- If the Subwoofer setting is “Off,” the setting cannot be set.

Setting Defeat

[Defeat] is selected on the Sound setup menu in step 3. Refer to “Sound Setup Operation” (page 33).

If Defeat is “On,” MX, EQ Presets and Parametric EQ functions are turned OFF. This disables any settings made for these functions.

Setting item: Defeat

Setting content: Off (Initial setting) / On

- When Defeat is set to “ON,” the Car Specific Sound Setup/MX (Media Xpander)/EQ Presets/Parametric EQ switch cannot be selected.
- Defeat is changed to “OFF” if you set BASS ENGINE SQ of Quick Sound Setting to “ON.”

About Time Correction

The distance between the listener and the speakers in a car vary widely due to the complex speaker placement. This difference in the distances from the speakers to the listener creates a shift in the sounds image and frequency characteristics. This is caused by the time delay between the sound reaching the listener’s right versus the left ear.

To correct this, this unit is able to delay the audio signal to the speakers closest to the listener. This effectively creates a perception of increased distance for those speakers. The listener can be placed at an equal distance between the left and right speakers for optimum staging. The adjustment will be made for each speaker in 3.4cm steps.

Example 1. Listening Position: Front Left Seat

Adjust the time correction level of the front left speaker to a high value and the rear right to zero or a low value.

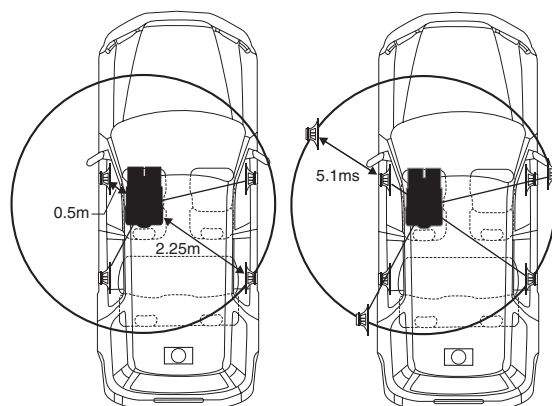

The sound is not balanced because the distance between the listening position and the various speakers is different. The difference in distance between the front left speaker and the rear right speaker is 1.75 m (68-7/8"). Here we calculate the time correction value for the front left speaker in the diagram on the above.

Conditions:

Farthest Speaker – listening position : 2.25 m (88-9/16")

Front left speaker – listening position : 0.5 m (19-11/16")

Calculation: $L = 2.25\text{ m} - 0.5\text{ m} = 1.75\text{ m}$ (68-7/8")

Time correction = $1.75 \div 343^{*1} \times 1000 = 5.1$ (ms)

**1 Speed of sound: 343 m/s (765 mph) at 20°C*

In other words, giving the front left speaker a time correction value of 5.1 ms makes it seem as if its distance from the listener is the same as the distance to the farthest speaker.

Time correction eliminates the differences in the time required for the sound to reach the listening position.

The time of the front left speaker is corrected by 5.1 ms so that its sound reaches the listening position at the same time as the sound of other speakers.

Example 2. Listening Position: All Seats

Adjust the time correction level of each speaker to almost the same level.

- 1 Sit in the listening position (driver's seat, etc.) and measure the distance (in meters) between your head and the various speakers.**
- 2 Calculate the difference between the distance correction value to the farthest speaker and the other speakers.**

$$L = (\text{distance to farthest speaker}) - (\text{distance to other speakers})$$

These values are the time correction values for the different speakers. Setting these values to make each sound reach the listening position at the same time as the sound of other speakers.

Time Correction Value List

Time Difference (msec)	Distance (cm)	Distance (inch)	Time Difference (msec)	Distance (cm)	Distance (inch)
0.0	0.0	0.0	5.1	173.4	68.3
0.1	3.4	1.3	5.2	176.8	69.7
0.2	6.8	2.7	5.3	180.2	71.0
0.3	10.2	4.0	5.4	183.6	72.4
0.4	13.6	5.4	5.5	187.0	73.7
0.5	17.0	6.7	5.6	190.4	75.0
0.6	20.4	8.0	5.7	193.8	76.4
0.7	23.8	9.4	5.8	197.2	77.7
0.8	27.2	10.7	5.9	200.6	79.1
0.9	30.6	12.1	6.0	204.0	80.4
1.0	34.0	13.4	6.1	207.4	81.7
1.1	37.4	14.7	6.2	210.8	83.1
1.2	40.8	16.1	6.3	214.2	84.4
1.3	44.2	17.4	6.4	217.6	85.8
1.4	47.6	18.8	6.5	221.0	87.1
1.5	51.0	20.1	6.6	224.4	88.4
1.6	54.4	21.4	6.7	227.8	89.8
1.7	57.8	22.8	6.8	231.2	91.1
1.8	61.2	24.1	6.9	234.6	92.5
1.9	64.6	25.5	7.0	238.0	93.8
2.0	68.0	26.8	7.1	241.4	95.1
2.1	71.4	28.1	7.2	244.8	96.5
2.2	74.8	29.5	7.3	248.2	97.8
2.3	78.2	30.8	7.4	251.6	99.2
2.4	81.6	32.2	7.5	255.0	100.5
2.5	85.0	33.5	7.6	258.4	101.8
2.6	88.4	34.8	7.7	261.8	103.2
2.7	91.8	36.2	7.8	265.2	104.5
2.8	95.2	37.5	7.9	268.6	105.9
2.9	98.6	38.9	8.0	272.0	107.2
3.0	102.0	40.2	8.1	275.4	108.5
3.1	105.4	41.5	8.2	278.8	109.9
3.2	108.8	42.9	8.3	282.2	111.2
3.3	112.2	44.2	8.4	285.6	112.6
3.4	115.6	45.6	8.5	289.0	113.9
3.5	119.0	46.9	8.6	292.4	115.2
3.6	122.4	48.2	8.7	295.8	116.6
3.7	125.8	49.6	8.8	299.2	117.9
3.8	129.2	50.9	8.9	302.6	119.3
3.9	132.6	52.3	9.0	306.0	120.6
4.0	136.0	53.6	9.1	309.4	121.9
4.1	139.4	54.9	9.2	312.8	123.3
4.2	142.8	56.3	9.3	316.2	124.6
4.3	146.2	57.6	9.4	319.6	126.0
4.4	149.6	59.0	9.5	323.0	127.3
4.5	153.0	60.3	9.6	326.4	128.6
4.6	156.4	61.6	9.7	329.8	130.0
4.7	159.8	63.0	9.8	333.2	131.3
4.8	163.2	64.3	9.9	336.6	132.7
4.9	166.6	65.7			
5.0	170.0	67.0			

About the Crossover

Crossover (X-OVER):

This unit is equipped with an active crossover. The crossover limits the frequencies delivered to the outputs. Each channel is controlled independently. Thus, each speaker pair can be driven by the frequencies for which they have been optimally designed.

The crossover adjusts the HPF (high pass filter) or LPF (low pass filter) of each band, and also the slope (how fast the filter rolls off the highs or lows).

Adjustments should be made according to the reproduction characteristics of the speakers. Depending on the speakers, a passive network may not be necessary. If you are unsure about this point, please consult your authorised Alpine dealer.

- Adjustment should be made according to the recommended crossover frequency of the connected speakers. Determine the recommended crossover frequency of the speakers. Adjusting to a frequency range outside that recommended may cause damage to the speakers. For the recommended crossover frequencies of Alpine speakers, refer to the respective Owner's Manual. We are not responsible for damage or malfunction of speakers caused by using the crossover outside the recommended value.

	Cut-off frequency (1/3 octave steps)		Slope		Level
	HPF	LPF	HPF	LPF	
Subwoofer (LPF)	----	20 Hz - 200 Hz	----	FLAT, -6, -12, -18, -24 dB/oct.	0 to -12 dB
Rear speaker (HPF)	20 Hz - 200 Hz	----	FLAT, -6, -12, -18, -24 dB/oct.	----	0 to -12 dB
Front speaker (HPF)	20 Hz - 200 Hz	----	FLAT, -6, -12, -18, -24 dB/oct.	----	0 to -12 dB

Low range High range

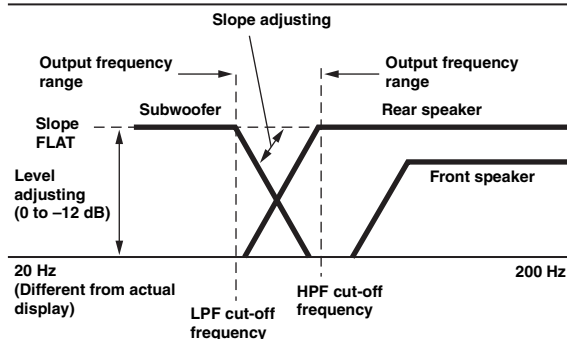

- HPF (high pass filter):** Cuts the lower frequencies and allows the higher frequencies to pass.
- LPF (low pass filter):** Cuts the higher frequencies and allows the lower frequencies to pass.
- Slope:** The level change (in dB) for a frequency change of one octave.
- The higher the slope value, the steeper the slope becomes.
- Adjust the slope to FLAT to bypass the HP or LP filters.
- Do not use a tweeter without the HPF on or set to a low frequency, as it may cause damage to the speaker due to the low frequency content.

Source Setup

Source Setup Operation

The parking brake must be engaged to access the Source mode screen. Attempting to access this screen while driving will display the warning-Unable to operate while driving.

The following steps 1 to 5 are common operations to each “Setting item” of Source Setup. Refer to each section for details.

- 1 Touch [Setup] icon of Top banner.**
The Setup main screen is displayed.
- 2 Touch [🎵 (Source)].**
The Source Setup screen appears.
- 3 Select the desired item.**



Setting items: Disc / Radio / AUX / App Connection Method / RSE

- 4 Touch [◀] or [▶] etc., to change its setting.**
 - When the pop-up window for setup is displayed, touch [X] to close the window after setting.
- 5 Touch [↩] to return to the previous screen.**
 - Immediately after changing the Source Setup (while the system is writing data automatically) do not turn the ignition key to OFF. Otherwise, the settings may not be changed.

Disc Setting

[Disc] is selected on the Source setup menu in step 3. Refer to “Source Setup Operation” (page 41).

- You can perform DVD setup in DVD video mode.
- Touch [Stop] before performing Disc setup.

Setting of the DVD Menu Language

Set the language used for the menus (title menu, etc.).

Setting item: DVD Menu Language

Setting contents: AUTO (Initial setting) / EN / JA / DE / ES / FR / IT / SV / RU / ZH

- When “AUTO” is selected, the primary menu language among the recorded ones is played.
- As for the language abbreviation, refer to “List of Language Codes” (page 73).

Setting of the Audio Language

Set the audio language produced from the speakers.

Setting item: Audio Language

Setting contents: AUTO (Initial setting) / EN / JA / DE / ES / FR / IT / SV / RU / ZH

- When “AUTO” is selected, the primary audio language among the recorded ones is applied.
- As for the language abbreviation, refer to “List of Language Codes” (page 73).

Setting of the Subtitle Language

Set the language of the subtitles displayed on the screen.

Setting item: Subtitle Language

Setting contents: AUTO (Initial setting) / EN / JA / DE / ES / FR / IT / SV / RU / ZH

- When “AUTO” is selected, the primary subtitle language among the recorded ones is applied.
- As for the language abbreviation, refer to “List of Language Codes” (page 73).

Changing the Language Setting

The DVD menu language, audio language and subtitle language can be set according to your preferences.

Once set, this becomes the default language. This function is convenient if you always want to listen in English, for example. (The language setting is not effective on some discs. In this case, the default language is set at the factory.)

- When the settings are changed, old settings are overwritten. Make a note of the current settings before making changes.
- To temporarily change the language of the current disc, either do so from the DVD menu or by using the operation described in the section “Switching the Audio Tracks” (page 27).
- If the disc does not include the selected language, the disc’s default language is set.

To play in a language other than those displayed

- 1 Touch [DVD Menu Language Code], [Audio Language Code] or [Subtitle Language Code].
The numeric keypad screen is displayed.
 - 2 Touch the 4-digit numeral of the language number.
To reference language numbers, refer to "List of Language Codes" (page 73).
 - 3 Touch [OK] to memorise the number.
- *The setting content changes to "Other" if the desired language code is input.*

Changing the Country Code Setting

Set the country code of which you want to set the rating level (Parental lock).

Setting item: Country Code

Setting contents: Auto / Other

- Auto:** The primary country code among those recorded is played.
- Other:** The setting content changes to "Other" if the desired country code is input.
- *If settings are changed, the old settings are overwritten. Make a note of the current settings before making changes. The settings will be cleared if the vehicle's battery is disconnected.*

- 1 Touch [Country Code Input].
- 2 Touch the 4-digit country code.
As for the country number, refer to "List of Country Codes" (page 74).
- 3 Touch [OK] to memorise the code.

Setting the Rating Level (Parental Lock)

This function can help limit the viewing of movies to children of appropriate age levels only.

Setting item: Parental Control

- *If settings are changed, the old settings are overwritten. Make a note of the current settings before making changes. The memory will be cleared if the vehicle's battery is disconnected.*
- *On unrated discs, playback will not be restricted even if the rating level is set.*
- *If you want to play back a disc with parental lock, and its use is currently restricted, change the rating level and the country number in order to play back the disc.*
- *Once set, this rating level remains in memory until changed. To enable playback of discs of higher rating levels, or to cancel the parental lock, the setting must be changed.*
- *Not all discs provide a parental lock. If you are unsure about a disc, play it first to confirm. Do not leave discs accessible to young children for whom you deem them inappropriate.*

- 1 Touch [Parental Control].
The numeric keypad screen is displayed.
- 2 Touch the numeric keypad to input a 4-digit password.
The initial number is 0000. Input number are displayed as "*".
- 3 Touch [OK] to memorise the number.
The Parental screen appears.

Set the rating level of PARENTAL

- 4 Touch [Parental Control].
- 5 Touch "◀" on "▶" to turn "On".
Select "Off" to cancel parental lock or if you do not want to set a rating level.
- 6 Touch [X] to return to the previous screen.
- 7 Touch [Parental Level]
- 8 Touch [◀] or [▶] to select the rating level (1 to 8).
The smaller the number, the higher the restriction.
- 9 Touch [X] to return to the previous screen.

Changing the password

- 1 Touch [Password Change].
The numeric keypad screen is displayed.
 - 2 Touch the input screen to enter a new 4-digit password.
- *Keep a note of the number somewhere safe in case you should forget it.*
- 3 Touch [OK] to memorise the number.
 - 4 Touch [↶] to return to the previous screen.

Changing the rating level temporarily

Some discs may request that you change the rating level set in the default settings during playback. In this case, the message "Do you wish to change Parental level? [OK] [Cancel]."

If this screen appears, change the level as follows:

- **To change parental level and play, touch [OK].**
When [OK] is touched, the numeric keypad input screen is displayed. Input the 4-digit password you set in "Setting the Rating Level (Parental Lock)," then touch [OK].
- **To play without changing the parental level, touch [Cancel].**
(If [Cancel] is touched, playback will be at the parental level set in "Setting the Rating Level (Parental Lock).")

Setting the TV Screen Mode

Use the procedure described below to modify the output screen according to the type of TV monitor (rear monitor) being used. If the rear monitor is not connected, the screen setting is 16:9.

Setting item: TV Screen

Setting contents: 4:3LB / 4:3PS / 16:9 (Initial setting)

- *For some discs, the picture may not be set to the selected screen size. (For details, refer to the explanation on the disc's jacket.)*

4:3 LETTER BOX:

Select this when connected to a conventional 4:3 size (normal TV aspect ratio) monitor. There may be black stripes visible at the top and bottom of the screen (when playing a 16:9 size movie). The width of these stripes will depend upon the original aspect ratio of the theatrical release of the movie.



4:3 PAN-SCAN:

Select this when connected to a conventional 4:3 size monitor. The picture will fill the entire TV screen. However, due to the mismatch in aspect ratio, parts of the movie at the extreme left and right sides will not be visible (when playing a 16:9 size movie).



16:9 WIDE:

Select this when connected to a wide screen TV. This is the factory setting.



Radio Setting

[Radio] is selected on the Source setup menu in step 3. Refer to “Source Setup Operation” (page 41).

PI SEEK Setting

Setting item: PI Seek

Setting contents: Auto / Off (Initial setting)

Receiving RDS Regional (Local) Stations

When Off is selected, the unit automatically keeps receiving the local RDS station.

Setting item: RDS Regional

Setting contents: On (Initial setting) / Off

Switching the Display Language of PTY (Programme Type)

Setting item: PTY Language

Setting contents: English (Initial setting) / Spanish / French / Italian / German / Portuguese / Swedish / Finnish / Russian / Dutch / Norwegian / Danish

Setting PTY31 (Emergency Broadcast) Reception

PTY31 (Emergency Broadcast) reception can be set to On/Off.

Setting item: PTY31

Setting contents: On (Initial setting) / Off

- The unit automatically gives priority to an emergency broadcast whenever it begins, and interrupts the programme you are currently listening to when PTY31 is set to “On.”
- The unit will show “Alarm” in the display during PTY31 reception.

Setting the TUNER (FM) Tone Quality (Tuner Condition)

This unit can set your preferred tone quality for FM radio source.

Setting item: FM Tuner Setting

Setting contents: Normal (Initial setting) / HiFi / Stable

Normal:	Standard setting
HiFi:	High-quality setting
Stable:	Control noise

- Noise may be more noticeable when HiFi is set, depending on the reception status. In this case, the Normal setting is recommended.

AUX Setting

[AUX] is selected on the Source setup menu in step 3. Refer to “Source Setup Operation” (page 41).

Setting the AUX Mode

Connection with external input devices is available through the iPod VIDEO connector. An optional adapter cable is required (standard RCA to 3.5ø mini-phono plug or 3.5ø to 3.5ø mini phono plug). You can also play back video connecting with an optional AV cable (4-pole mini AV plug to 3-RCA).

Setting item: *AUX In*

Setting contents: *iPod Video (Initial setting) / AUX*

iPod Video: Set when connected to an iPod or iPhone.
AUX: Set when connected to an external input device.

Usable 4-pole mini AV plug

The unit accepts the following 4-pole mini AV plug pin-out:

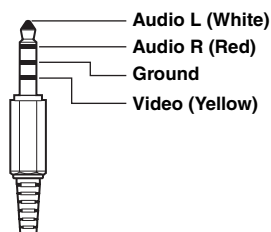

- Please check pin-out carefully before use of this product. Depending on the cable, there may be no picture and/or sound.

Setting the Primary AUX Name (AUX Setup)

When AUX In is set to “AUX”, this setting is available.

Setting item: *Primary Name*

Setting contents: *AUX (Initial setting) / DVD / GAME / EXT.DVD / DVD-CHG. / DVB-T / TV / USB-PLAYER / DAB*

- When a DVB-T tuner or USB-PLAYER (sold separately) is connected, you can use it to connect one more External Input device. Setting the Secondary name can change the mode name display of this device.

Setting the Secondary AUX Name

Secondary name can be set only when Primary name is set to “DVB-T” or “USB-PLAYER.”

Setting item: *Secondary Name*

Setting contents: *OFF (Initial setting) / AUX-2 / DVD / GAME / EXT.DVD / DVD-CHG / DVB-T*¹ / TV / USB-PLAYER*² / DAB*

- The selected source name is displayed instead of AUX mode name.

*¹ If the Primary Name is DVB-T, DVB-T is not displayed as a Secondary Name option.

*² If the Primary Name is USB-PLAYER, USB-PLAYER is not displayed as a Secondary Name option.

Setting Direct Touch Operation

If DVB-T is set as the Primary Name or Secondary Name, this setting is available.

Setting item: *Direct Touch*

Setting contents: *On (Initial setting) / Off*

On: Direct Touch operation is available on the DVB-T screen.
Off: Direct Touch operation is not available on the DVB-T screen.

Switching the Visual Input Signal System

After setting to “On” in “Setting the AUX Mode,” this setting can be carried out. The video input type can be changed.

Setting item: *Signal*

Setting contents: *Auto (Initial setting) / NTSC / PAL*

Auto: The video input signal type (NTSC or PAL) will be automatically selected.
NTSC/PAL: Choose the video input signal type manually.

Setting the App Connection Method

[App connection method] is selected on the Source setup menu in step3. Refer to “Source Setup Operation” (page 41).

Set ALPINE APP to USB when an iPhone is connected, or set to BLUETOOTH when an Android Smartphone is paired.

Setting item: *App Connection Method*

Setting contents: *None / USB (iPhone) (Initial setting) / Bluetooth (Android)*

None: No Smartphone is connected.
USB (iPhone): When an iPhone is connected to IVE-W585BT's USB port, you can, program the unit's sound tuning parameters, or communicate with SNS.
Bluetooth (Android): Set this when an Android Smartphone is paired with this unit via BLUETOOTH technology. At this time, you can, program the unit's sound tuning parameters, or communicate with SNS.

- After the above setting, turn the ignition key off (ACC OFF) and on again (ACC ON).
- For this function to work properly, specific applications must be installed on your Smartphone before connection. Consult your Alpine dealer or the Alpine website for details.
- Only the iPhone and certain Android Smartphones support this function.

RSE Setting

[RSE] is selected on the Source setup menu in step 3. Refer to “Source Setup Operation” (page 41).

Setting the Rear Seat Entertainment System

Video can be output to the rear monitor.

Setting item: *RSE*

Setting contents: *Off (Initial setting) / On*

BLUETOOTH Setup

The BLUETOOTH function is always available on this unit. You can, therefore, search for a BLUETOOTH device for pairing at any time.

BLUETOOTH Setup Operation

The parking brake must be engaged to access the Setup screen. Attempting to access this screen while driving will display the warning-Unable to operate while driving.

The following steps 1 to 5 are common operations to each “Setting item” of BLUETOOTH Setup. Refer to each section for details.

1 Touch [Setup] icon of Top banner.
The Setup main screen is displayed.

2 Touch [Bluetooth] (BLUETOOTH).
The BLUETOOTH Setup screen appears.

3 Select the desired item.

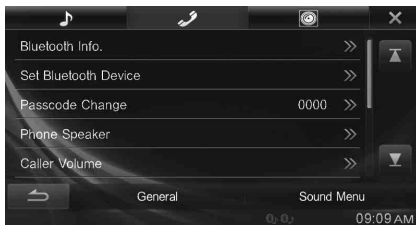

Setting items: Bluetooth Info. / Set Bluetooth Device / Passcode Change / Phone Speaker / Caller Volume / Microphone Level / Ring Tone Volume / Delete Call History / Contact List Order

4 Touch [Left Arrow] or [Right Arrow] etc., to change its setting.
• When the pop-up window for setup is displayed, touch [X] to close the window after setting.

5 Touch [Back Arrow] to return to the previous screen.
• Immediately after changing the BLUETOOTH Setup (while the system is writing data automatically) do not turn the ignition key to OFF. Otherwise, the settings may not be changed.

Displaying BLUETOOTH Information

[Bluetooth Info.] is selected on the BLUETOOTH setup menu in step 3.

Refer to “BLUETOOTH Setup Operation” (page 45). You can display the BLUETOOTH device name and device address of this unit.

Setting item: Bluetooth Info.

Registering the BLUETOOTH Device

[Set Bluetooth Device] is selected on the BLUETOOTH setup menu in step 3.

Refer to “BLUETOOTH Setup Operation” (page 45). The BLUETOOTH device is used when a connectable BLUETOOTH compatible device is searched and connected from this unit, or a new BLUETOOTH compatible device is registered.

1 Touch [Set Bluetooth Device].

2 Touch [Search] of “No Device.”

3 Touch [Audio], [Hands-free] or [Both] of the device you want to connect from the list.

Audio: Sets for use as an Audio device

Hands-free: Sets for use as a Hands Free Device.

Both: Sets for use as both an Audio device and Hands Free Device.

- You can register up to 3 BLUETOOTH compatible mobile phones.

4 When the device registration is complete, a message appears and the device returns to normal mode.

- The BLUETOOTH registration process differs depending on the device version and SSP (Simple Secure Pairing). If a 4 or 6 character Passcode appears on this device, enter the Passcode using the BLUETOOTH compatible device. If a 6 character Passkey appears on this device, make sure the same passkey is displayed on the BLUETOOTH compatible device and touch “Yes.”
- If all the 3 devices have been registered, you cannot register the 4th device. To register another device, you need to delete one of the devices from position 1 to 3 first.

Setting the BLUETOOTH Device

Select one of 3 paired BLUETOOTH compatible devices that you previously registered.

1 Touch [Set Bluetooth Device].

2 Touch [Audio] or [Hands-free] of the device you want to connect from the Paired Device list.

Deleting a BLUETOOTH Device from the list

You can delete the information of a previously connected BLUETOOTH compatible device.

1 Touch [Set Bluetooth Device].

2 Touch [Delete] of the BLUETOOTH compatible device to delete from the Paired Device list.

3 Touch [OK].

- Touching [Cancel] will cancel the setting.

Setting the Passcode

[**Pass code Change**] is selected on the BLUETOOTH setup menu in step 3.
Refer to “BLUETOOTH Setup Operation” (page 45).
You can set the code for connecting with a BLUETOOTH compatible device.

Setting item: Passcode Change

1 Touch [**Passcode Change**].

A numeric keypad screen is displayed.

2 Enter a 4-digit passcode, and then touch [**Enter**].

- *The initial number is 0000.*
- *For details on how to input the numeric keypad, refer to “Numeric Keypad Input Operations” (page 24).*

Selecting the Output Speaker

[**Phone Speaker**] is selected on the BLUETOOTH setup menu in step 3.
Refer to “BLUETOOTH Setup Operation” (page 45).
You can select which speaker in the car will output the audio from the phone.

Setting item: Phone Speaker

Setting contents: ALL (Initial setting) / FRONT L / FRONT R / FRONT LR

- ALL: The sound is output from all speakers in car.
- FRONT L: The sound is only output from the front left speaker.
- FRONT R: The sound is only output from the front right speaker.
- FRONT LR: The sound is output from the front left and front right speakers.

- *The setting cannot be adjusted during a phone call. Adjust the setting before placing a call.*

Adjusting the Caller Volume

[**Caller Volume**] is selected on the BLUETOOTH setup menu in step 3.
Refer to “BLUETOOTH Setup Operation” (page 45).
You can adjust the receive volume, during the call.

Setting item: Caller Volume

Setting contents: 1 to 11 (Initial setting: 5)

Adjusting the Microphone Level

[**Microphone Level**] is selected on the BLUETOOTH setup menu in step 3.
Refer to “BLUETOOTH Setup Operation” (page 45).
You can adjust the transmit volume, during the call.

Setting item: Microphone Level

Setting contents: 1 to 11 (Initial setting: 5)

Adjusting the Ring Tone Volume

[**Ring Tone Volume**] is selected on the BLUETOOTH setup menu in step 3.
Refer to “BLUETOOTH Setup Operation” (page 45).
You can adjust the volume of the incoming call.

Setting item: Ring Tone Volume

Setting contents: 1 to 11 (Initial setting: 5)

Deleting All the Histories

[Delete Call History] is selected on the BLUETOOTH setup menu in step 3.

Refer to "BLUETOOTH Setup Operation" (page 45).

Dialled/Received/Missed Incoming histories are all deleted.

Setting item: Delete Call History

1 Touch [Delete Call History]

The confirmation screen is displayed.

- When there is no history, this option is not available.

2 Touch [OK].

All the histories are deleted.

Changing the Phone book List Order

[Contact List Order] is selected on the BLUETOOTH setup menu in step 3. Refer to "BLUETOOTH Setup Operation" (page 45).

The phone book is listed alphabetically according to the initial letter of name.

You can choose to arrange the phone book list order according to the initial letters of the First Name or Last Name.

Setting item: Contact List Order

Setting contents: First Name (Initial setting) / Last Name

- To reflect the setting, the phone book needs to be reload. For details on phone book loading operations, refer to "Phone Book Function" (page 54).

Camera Setup

Camera Setup Operation

With an optional camera connected, its video is output to the monitor. When the camera is connected, set this item.

The parking brake must be engaged to access the Setup screen. Attempting to access this screen while driving will display the warning-Unable to operate while driving.

The following steps 1 to 5 are common operations to each "Setting item" of Camera Setup. Refer to each section for details.

1 Touch [Setup] icon of Top banner.

The Setup main screen is displayed.

2 Touch [CAMERA].

The Camera Setup screen appears.

3 Select the desired item.



Setting items: Camera / Camera Interrupt (Power OFF Mode)

4 Touch [◀] or [▶] etc., to change its setting.

- When the pop-up window for setup is displayed, touch [X] to close the window after setting.

5 Touch [↶] to return to the previous screen.

- Immediately after changing the Camera Setup (while the system is writing data automatically) do not turn the ignition key to OFF. Otherwise, the settings may not be changed.

AUX Camera Setting

[Camera] is selected on the Camera setup menu in step 3. Refer to “Camera Setup Operation” (page 47).

Setting the Camera Input

Setting item: Camera Select / Camera Signal*/Guide Adjustment*

Setting contents: Off (Initial setting) / Rear

* If “Camera Select” is set to “Off,” this option is not available.

Setting the AUX Camera Signal Input

When the AUX camera is connected, the video input signal type can be chosen.

Setting item: Camera Signal

Setting contents: AUTO (Initial setting) / NTSC / PAL

NTSC/PAL: Choose the video input signal type manually.

AUTO: The suitable video input signal type will be automatically chosen between NTSC and PAL.

Adjusting the Rear Camera Guide

If you select “Rear” you can adjust the camera guide position.

Setting item: Guide Adjustment

1 Touch [Guide Adjustment].

The camera guide adjustment screen is displayed.

2 Touch the guide you intend to adjust.

Guide line can also be selected by touching [▲] [▼].

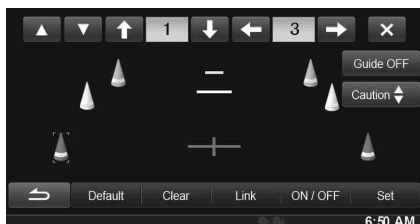

3 Touch [▲], [▼], [←] or [→] to adjust the position of the guide.

- Touching [Clear] clears adjustments and returns to the setting before guide line alteration.

4 After the adjustment is completed, touch [Set].

Adjusting guides simultaneously

Touch [Link].

The 3 vertical guides of the currently-selected guide link together, allowing them to be adjusted simultaneously.

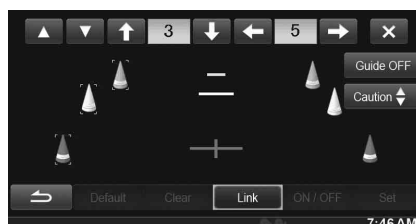

Turning guide display ON/OFF

Turning the selected guide off.

1 Touch [ON/OFF].

The currently selected guide will turn off.

2 To turn the guide on, touch [ON/OFF] again.

- Guides that are turned off are still adjustable.

Returning guides to default.

1 Touch [Default].

A message window will appear.

2 Touch [OK].

Adjusted values will return to default settings.

Guide Display ON/OFF Setting

1 Touch [Guide OFF] on the Rear camera display screen.

The guide disappears, and then the [Guide OFF] switch changes to [Guide ON].

2 Touch [Guide ON] to turn on the guide.

Adjusting the Caution Display Location

Touch [Caution ▲▼].

- For each touch, the caution location moves to the top or bottom of the screen.

Camera Interrupt Setting (Power OFF Mode)

[Camera Interrupt] is selected on the Camera setup menu in step 3. Refer to “Camera Setup Operation” (page 47).

You can set whether to display the rear camera image when the gear lever is moved to the reverse (R) position while the unit is power off.

Setting item: Camera Interrupt (Power OFF Mode)

Setting contents: On / Off (Initial setting)

On: The rear camera image is displayed

Off: The rear camera image is not displayed

About the Rear Camera Guide

To display the guide, set "Guide Display ON/OFF Setting" (page 48) to On. Also, to adjust the guide, refer to "Adjusting the Rear Camera Guide" (page 48). You can also turn off the guide in the Rear camera display screen.

■ Indication mark meaning

When the car is put into reverse gear, the monitor switches to the rear view camera image. Guides appear to help visualize the car's width and distance from the rear bumper.

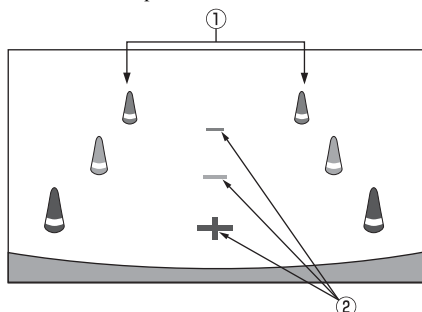

① Car width extension marks (red, yellow and green in order of distance)

If properly calibrated, the marks indicate the car's width. This helps guide the car's path when backing up in a straight line.

The marks represent the distance from the rear of the car (from the rear end of the bumper).

- The marks do not move in synchronization with the steering wheel.
- Set the marks to suit the car's width.

② Distance guidance marks

The marks represent the distance from the rear of the car (from the rear end of the bumper).

- The marks do not move in synchronization with the steering wheel.
- We recommend that you measure the actual distance to the marks when parked on a level surface.
- Depending on the condition of the car or road surface, the range of vision may vary.
- The camera has a limited range of vision. Objects at extreme angles to the camera (e.g. under the bumper or at opposite ends of the bumper) may not be in its field-of-vision.
- The rear camera image may have a tint which is different from the actual surroundings.
- Depending on the car, the guidance may deviate to the right or left. This is not a malfunction.

■ Distance guidance mark

The distance guides represent the ground level distance from the rear bumper. It is difficult to accurately estimate the distance to objects above ground level.

In the following example, the distance to A is 0.5 m and the distance to B is 1 m.

<Screen>

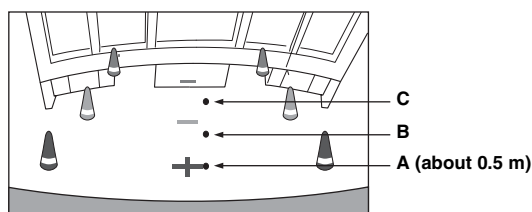

<Positions of A, B and C>

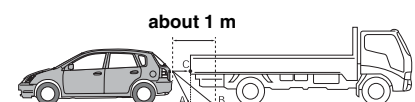

In the screen, according to the distance guidance marks, the truck seems to be parked about 1 m away (at the position B). In actual fact, however, if you reversed to position A, you would collide with the truck. In the screen, positions A, B and C seem to be located in order of proximity. However, in actual fact, the position A and C are the same distance, and B is farther away than positions A and C.

- The car width extension mark represents the distance to the road surface. The distance to an object on the road is not accurately represented by the guides.

Error between the screen and the actual road surface

In the following conditions, errors are produced between the screen guidance and the actual road surface. (The illustrations represent a case when the camera is installed in the standard position.)

■ When there is a steep upward slope behind the car (example)

<Screen>

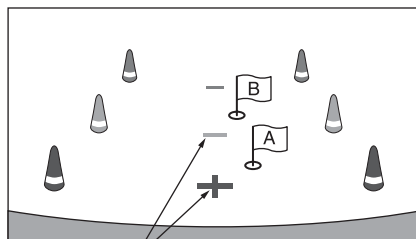

Distance guidance marks

<Situation of the car>

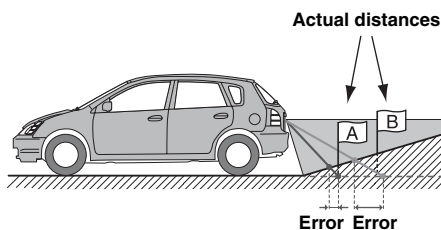

The distance guidance mark represents the distance to a flat road surface. Therefore in the case of an upward slope behind the car, the distance guides are displayed closer to the rear bumper than the actual distance. For example, if there is an obstacle on the upward slope, it may appear farther away than its actual position. Also, an error may occur between the guidance and the actual path of the car on the road surface.

■ When there is a steep downward slope behind the car (example)

<Screen>

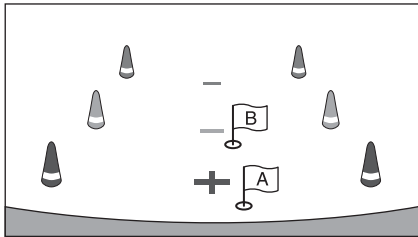

<Situation of the car>

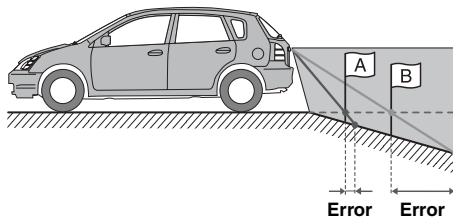

In the case of a downward slope behind the car, the distance guides are displayed farther from the rear bumper than the actual distance.

If there is an obstacle on the downward slope, it seems closer than its actual position.

Also, an error may occur between the guidance and the actual path of the car on the road surface.

BLUETOOTH Operation

Setup Before Using

About BLUETOOTH

BLUETOOTH is a wireless technology allowing communication between a mobile device or personal computer over short distances. This enables a hands-free call or data transmission between BLUETOOTH compatible devices. BLUETOOTH transmission is available in the unlicensed 2.4 GHz spectrum if the distance between devices is within 10 meters. For details, refer to the BLUETOOTH website (<http://www.bluetooth.com/>).

- Depending on the BLUETOOTH version, a BLUETOOTH compatible device may not be able to communicate with this unit.
- Proper function of this unit with all BLUETOOTH compatible devices is not guaranteed. For handling of the BLUETOOTH compatible device, consult your ALPINE dealer or ALPINE website.
- Depending on the surroundings, BLUETOOTH wireless connection may be unstable.
- When you place a call, or perform setup operations, be sure to stop your car in a safe place.
- Depending on the connected BLUETOOTH compatible device(s), the function may differ. Also refer to the Owner's Manual of the connected device(s).

About the Hands-Free Phone

Hands-free calls are possible when using a HFP (Hands-Free Profile) compatible mobile phone with this unit.

- Avoid performing a hands-free call in heavy traffic or on narrow or winding streets.
- Close the windows while calling to reduce background noise.
- If both calling parties are using hands-free devices, or the call is made in a noisy location, difficulty hearing the other person's voice is normal.
- Depending on telephone line conditions or certain mobile devices used, voices may sound unnatural.
- When using a microphone, speak as directly as you can into the microphone to obtain the best sound quality.
- Certain mobile phone features are dependent on the capabilities and settings of your service provider's network. Additionally, certain features may not be activated by your service provider, and/or the provider's network settings may limit the feature's functionality. Always contact your service provider about feature availability and functionality.

All features, functionality, and other product specifications, as well as the information contained in the Owner's Manual are based upon the latest available information and are believed to be accurate at the time of printing.

Alpine reserves the right to change or modify any information or specifications without notice or obligation.

Before Using BLUETOOTH

Before using the hands-free phone/audio function, the following settings need to be made.

Register a BLUETOOTH device in this unit (see page 45).

- You can search for this unit using a BLUETOOTH compatible device, and then connect that BLUETOOTH compatible device to this unit. The device name of this unit is "IVE-W585BT" and the initial number of the passcode is "0000." Also refer to the Owner's Manual of the connected device(s).

Hands-Free Phone Control

■ Display example for Phone menu screen



- ① BLUETOOTH devices Name
- ② Favorites Display: Short Cut icon
Dialed/Received/Missed Display: Each histories icon

Connecting a BLUETOOTH Device

Registering a BLUETOOTH device in IVE-W585BT enables automatic connection.

If it does not connect automatically, run through the connection procedure again.

- 1 Press the  (Phone) button.**
The Phone menu screen is displayed.
- 2 Touch [Connect].**
BLUETOOTH connection will start.

Disconnecting the BLUETOOTH Connection

Touch [Disconnect].

The BLUETOOTH connection is disconnected.



Changing the connecting BLUETOOTH Device

If multiple BLUETOOTH devices are registered in this device, you can change the connection among the registered devices.

- 1 Press the  (Phone) button.**
The Phone menu screen is displayed.
- 2 Touch [Change Device].**
The Set Bluetooth Device screen is displayed.
- 3 Touch [Audio] or [Hands-free] of the selected device.**
The connection will transfer to the selected device.

Answering a Call

Incoming calls are announced by the received call ring tone and a displayed message (PHONE No., etc.).

- 1 An incoming call triggers the ringtone and an incoming call display.**
- 2 Touch [] or press  (Phone) button.**
The call starts.
 - *During a call, the audio for the current mode on the unit is muted. After calling, playback will resume.*
 - *When the caller's number is transmitted to the system, if the caller's name is stored in the phone book, the name is displayed. If the name is not stored, the number is displayed.*

Adjusting Ringtone Volume

The ringtone volume is adjustable on the incoming call message screen.

Touch [] or [] for "Vol."

Hanging up the Telephone



Touch [].
The call finishes.

Calling

Use the Phone menu screen to make a phone call.





Using Short Cut Dialling to Make a Call

You can assign up to 4 phone numbers for one-touch dialling to make a call easily. For how to assign one-touch dialling, refer to "Assigning as a Short Cut Dialling Number" (page 55).

- 1 Press the  (Phone) button.**
The phone menu screen is displayed.
- 2 Touch [ Favorites].**
- 3 Touch [Dial1], [Dial2], [Dial3] or [Dial4].**
The phone call is sent to the stored number.
 - *Pressing and holding [Dial1], [Dial2], [Dial3] or [Dial4] displays the Shortcut Dialling Edit screen. The only available editing operation is deletion.*
 - *If a name has been registered, the name is displayed on the shortcut button.*

Dialling a Number In Call History

You can use 3 types of history to make a phone call. Each history saves up to 20 phone numbers. If the limit is exceeded, the oldest phone number is deleted.

- 1 Press the  (Phone) button.**
The phone menu screen is displayed.
- 2 Touch [ Dialed], [ Received] or [ Missed].**
The last four histories are displayed.

To make a call by one of the last four histories



- 3 Touch the icon you want to call.**
The phone call is started.

To make a call by one of all the histories



- 3 Touch [All].**
- 4 Touch the name from the call history.**
The details screen of the call history is displayed.
- 5 Touch [].**
The phone call is started.
 - *Touching [Delete] deletes the selected histories.*

Dialing a Number In the Phone Book

You can use the phone book of the mobile phone to make a phone call. Before using, you need to transfer the phone book from the mobile phone to the system. For details on how to transfer the phone book, refer to "Synchronising the Phone Book" (page 54).

- 1 Press the  (Phone) button.**
The phone menu screen is displayed.
- 2 Touch .**
- 3 Touch the person name or the telephone number from the Phone Book list.**
- 4 Touch .**
The phone call is started.

Entering a Phone Number to Make a Call

- 1 Press the  (Phone) button.**
The phone menu screen is displayed.
- 2 Touch .**
The number input screen appears.
- 3 Enter the phone number you wish to call.**
 - You can input "+" by touching "0" repeatedly.
 - You can enter up to 31 digits.
- 4 Touch .**
- 5 Touch [Call].**
The phone call is started.

Redial Function

You can redial the person you have previously called.

- 1 Press the  (Phone) button.**
The phone menu screen is displayed.
- 2 Touch [Redial].**
- 3 Touch [Call].**
The phone call is started.

Voice Dial Function

While connecting to a voice dial compatible hands-free phone, you can make a telephone call by voice dial operation.

- 1 Press and hold the  (Phone) button for at least 3 seconds.**



The Voice Dial mode screen is activated.

- 2 Say the telephone number* or name* you want to call, into the microphone.**

* The number and name depend on the voice dial information stored in the mobile phone.

- 3 To finish the Voice Dial mode, touch [X].**

- You can perform this operation only when a voice dial compatible mobile phone is connected.
- The Voice Dial function performance depends on the recognition range of the mobile phone and mounting location of the microphone. Note when the microphone is mounted.
- Voice dial operation depends on the function being available on the mobile phone. For details, refer to the owner's manual of the mobile phone.
- Depending on the mobile phone, the voice dial operation may finish automatically.

Operations During a Conversation

■ Display example



- ① Name and phone number
- ② Conversation time

Adjusting the Speech Volume



You can adjust the transmit volume and receive volume respectively.

Touch [] or [] for "Vol."

: Microphone Level

: Caller Volume

You can adjust the volume in 11 levels.

Touch [] to turn down the volume. Touch [] to turn up the volume.

Changing the Voice Output

The voice output for calls is switchable between car speakers and the mobile phone speaker.

Touch [] [] [].

- Depending on the mobile phone, this operation may not be possible.

DTMF (Touch-Tone) Function

Transmits a DTMF (Touch-Tone) during a call.

- 1 Touch [Keypad].**
The number input screen appears.
- 2 Input number.**

- You can transmit a Touch-Tone signal during a call.

Phone Book Function

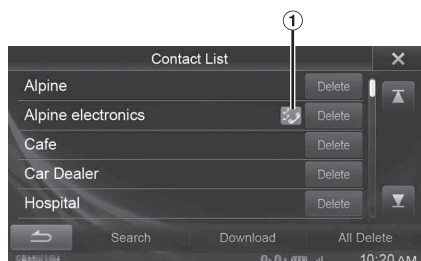

■ Display example for Phone Book screen





- ① An icon is displayed to indicate that multiple phone numbers are registered under an entry.

Synchronising the Phone Book

You can synchronise the system's phone book with the mobile phone's phone book.



- 1 Press the  (Phone) button.**
The phone menu screen is displayed.
 - 2 Touch [].**
 - 3 Touch [Download].**
 - 4 Touch [SYNC].**
Synchronisation of the phone books starts.
- You can store up to 1,000 phone numbers in the phone book.
 - You can store up to 3 phone numbers by one person's name.

Adding the Phone Book

- 1 Press the  (Phone) button.**
The phone menu screen is displayed.
- 2 Touch [].**
- 3 Touch [Download].**
- 4 Touch [Add].**
Stays on standby for connection of the mobile phone.
 - Touch [Cancel] to cancel the standby mode.
- 5 The mobile phone accesses this unit and then transfers the phone book from the mobile phone to this unit.**



Searching in the Phone Book

If there are 6 or more entries in the phone book you transferred, you can make a call using the phone book search function.



- 1 Press the  (Phone) button.**
The Phone menu screen is displayed.
- 2 Touch [].**
The Contact list screen is displayed.
- 3 Touch [Search].**
The Keypad input screen is displayed.
- 4 Input the first letter of an entry you want to search for.**
The number of targeted entries with the input first letter is displayed in the upper right corner of the screen. To narrow down a search, input more letters.
 - After inputting characters, if the number of narrowed entries is 5 or less, the targeted entry list is displayed.
- 5 Touch [OK].**
The targeted entry of the Phone Book list is displayed.
- 6 Touch the person name or the telephone number from the Phone Book list.**
- 7 Touch [].**

Deleting the Phone Book Entries

Deleting One Entry from the Phone Book

- 1 Press the  (Phone) button.**
The Phone menu screen is displayed.
- 2 Touch [.**
The Phone Book screen is displayed.
- 3 Touch [Delete].**
The confirmation screen is displayed.
If multiple phone numbers are registered, they are all deleted.
- 4 Touch [OK].**
The selected number is deleted.

Deleting All Entries from the Phone Book



- 1 Press the  (Phone) button.**
The Phone menu screen is displayed.
- 2 Touch [.**
The Phone Book screen is displayed.
- 3 Touch [All Delete].**
The confirmation screen is displayed.
- 4 Touch [OK].**
All entries of the phone book are deleted.

Assigning as a Short Cut Dialling Number

Assigning from Call History

- 1 Press the  (Phone) button.**
The Phone menu screen is displayed.
- 2 Touch [Dialled], [Received] or [Missed].**
The last four histories are displayed.
- 3 Touch [All].**
- 4 Touch the person name you intend to assign as the Short Cut dialling number.**
The details screen of the Call History is displayed.
- 5 Touch [Preset].**
The details screen for the Short Cut is displayed.
- 6 Touch [Save].**
The phone number is assigned to the selected Short Cut dialling number.
 - If Dial1, Dial2, Dial3 or Dial4 is already registered, it is overwritten.
 - Touch [Delete] to delete an assigned short cut dialling number.

Assigning from the Phone Book

- 1 Press the  (Phone) button.**
The Phone menu screen is displayed.
- 2 Touch [.**
The Phone Book screen is displayed.
- 3 Touch the phone number you intend to assign as the Short Cut dialling number.**
The details screen of the Phone book is displayed.
- 4 Touch [Preset].**
The details screen for the Short Cut is displayed.
- 5 Touch [Save].**
The phone number is assigned to the selected Short Cut dialling number.
 - If Dial1, Dial2, Dial3 or Dial4 is already registered, it is overwritten.
 - Touch [Delete] to delete an assigned short cut dialling number.

Call Waiting Function

If a call comes in from another phone during a call, a notice is displayed on the screen. This function can only be used if the connected mobile phone has a call waiting function service included.

Receiving calls during a current call

If a new call comes in during a current call, a screen allowing you to negotiate the new call is displayed.

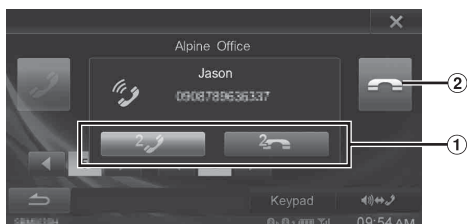

- ① Touch [2] to take the new call and put the current party on hold.
Touch [3] to not take the new call and continue your call with the current party.
- ② Touch [3] or press the Media Control button 3 to end your call with the current call and take the new call.

Switching calls



- ③ Touch to switch the call.

- This unit supports only the Call Waiting function of a mobile phone. The second call function and three-way calling function of a mobile phone cannot be operated from this unit. Also the screen display may malfunction.

BLUETOOTH Audio

If a BLUETOOTH compatible mobile phone, portable player, etc. is connected by wireless, you can play back a song (operation is controllable from the unit).

Display example for BLUETOOTH Audio main screen

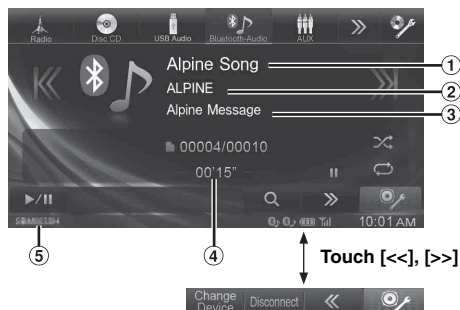

- ① Song title
- ② Artist title
- ③ Album title
- ④ Playing time
- ⑤ BLUETOOTH devices Name

- The displayed onscreen buttons may differ depending on the AVRCP version.
- Status Indicator/Song title/Artist title/Album title/Elapsed time do not display for AVRCP Ver. 1.0.
- To play back audio, a mobile phone or a portable player conforming to A2DP (Advanced Audio Distribution Profile) or AVRCP (Audio/Video Remote Control Profile) is required.
Not all functions work with all devices.
- During a call, sound on the BLUETOOTH audio source is muted.

Compatible AVRCP versions: 1.0, 1.3, 1.4

- Available functions may differ depending on the AVRCP version.

Playback

- 1 Touch **[Bluetooth-Audio]** of Top banner.
- 2 Touch **[⏮]** or **[⏭]** to select the desired track (file).

Returning to the beginning of the current file:

Touch **[⏮]**.

Fast backward the current file:

Touch and hold **[⏮]**.

Advance to the beginning of the next file:

Touch **[⏭]**.

Fast forward the current file:

Touch and hold **[⏭]**.

- The **⏮**, **⏭** buttons provide the same functions above.

- 3 To pause playback, touch **[⏸/⏹]**.

Repeat Play

Available for AVRCP Ver. 1.3 and 1.4 only.

Touch **[🔄] during playback.**

The repeat mode switches every time the button is touched.

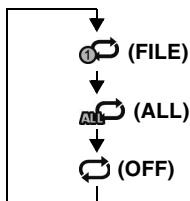

- Operations may differ depending on the connected **BLUETOOTH** compatible device.

M.I.X. (Random Play)

Available for AVRCP Ver. 1.3 and 1.4 only.

Touch **[⌵] during playback.**

The M.I.X. mode switches every time **[⌵]** is touched.

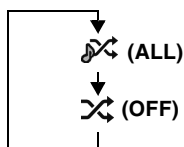

Search Function

Available for AVRCP Ver. 1.4 only.

The displayed list differs with the connected **BLUETOOTH** device.

Touch **[🔍 (Search)] of Bottom banner during playback.**

Select the track, etc., you want to listen to from the displayed list.

- Operations may differ depending on the connected **BLUETOOTH** compatible device.

Auxiliary Device (Optional)

Operating Auxiliary Devices (Optional)

To operate devices connected to the AUX terminals of IVE-W585BT, follow the procedure described below.

- Set AUX In to "AUX." Refer to "Setting the AUX Mode" (page 44).
- Depending on the connected unit, the onscreen buttons may not work, or their operation may differ.

⚠ WARNING

It is dangerous (and illegal in many states) for the driver to watch TV/video while driving the vehicle. The driver may be distracted from looking ahead and an accident could occur.

Install the IVE-W585BT correctly so that the driver cannot watch TV/video unless the vehicle is stopped and the emergency brake is applied.

If the IVE-W585BT is not installed correctly, the driver will be able to watch TV/video while driving the vehicle and may be distracted from looking ahead and cause an accident. The driver or other people could be severely injured.

- If you try to activate the auxiliary device while driving, the display will show the warning-Picture off for your safety.

Touch [AUX]*¹ or [AUX2]*² of Top banner.

The AUX mode screen is displayed.

*¹ The name which is given as the mode name in "Setting the Primary AUX Name (AUX Setup)" (page 44) and "Setting the Secondary AUX Name" (page 44) is displayed.

*² When "Setting the Secondary AUX Name" (page 44) is set to "Off," this option is not available.

AUX Operation Screen Display During Video File Playback

Touch the screen.

The AUX operation screen is displayed.

■ Example for AUX, AUX2, DVD, Game mode display



- The operation screen changes to the visual screen in the AUX mode for 5 seconds after an operation has been performed. To hide the AUX operation screen, touch the video display area.

Touch the display panel to display the operation screen again.

- Setting the AUX name for EXT.DVD, DVD-CHG, DVB-T, USB-PLAYER, DAB, and TV mode displays their individual operation switches and enables operation. Refer to "Setting the Primary AUX Name (AUX Setup)" (page 44) and "Setting the Secondary AUX Name" (page 44).

Operating an External DVD Player

To operate an External DVD player (Optional), set “Setting the Primary AUX Name (AUX Setup)” (page 44) or “Setting the Secondary AUX Name” (page 44) to “EXT.DVD.”

Change to the External DVD Mode

Touch [EXT.DVD] of Top banner.

The display shows the EXT. DVD mode screen.

About the DVD Operation Screen

When the external DVD player playback screen is displayed, you can touch the screen to display the operation screen. For details on how to operate, refer to the Owner’s Manual of the connected DVD player.

External DVD player display example

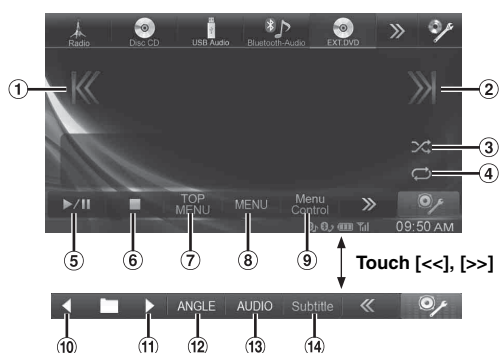

- ① [K]*
Touch the switch to go back to the beginning of the current chapter/track/file. Touch the switch once more to find the beginning of the previous chapter/track/file. Touch and hold to fast reverse.
- ② [J]*
Touch the switch to advance to the beginning of the next chapter/track/file. Touch and hold to fast forward.
- ③ [X]
Starts/Stop M.I.X. play.
- ④ [R]
Starts/Stop repeat play.
- ⑤ [▶/||]
Switches between play and pause.
- ⑥ [■]
Touching during play initiates a pre stop. Touching again stops play.
- ⑦ [TOP MENU]
Calls up the Top Menu screen.
- ⑧ [MENU]
Calls up the Menu screen.
- ⑨ [Menu Control]
Calls up the menu operation mode.
- ⑩ [▼]
Switches the programme/playlist/folder down.
- ⑪ [▶]
Switches the programme/playlist/folder up.
- ⑫ [ANGLE]
Switches angle.
- ⑬ [AUDIO]
Switches audio.

- ⑭ [Subtitle]
Switches sub titles.

* The ◀◀, ▶▶ buttons provide the same functions above.

Menu operation mode screen display example

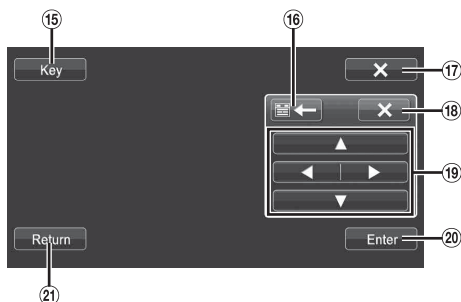

- ⑮ [Key]
The menu operation mode will be displayed.
- ⑯ [Key panel], [Key panel]
Moves key panel location.
- ⑰ [X]
Closes menu operation mode.
- ⑱ [X]
Closes key panel.
- ⑲ [▲], [◀], [▼], [▶]
Moves menu cursor.
- ⑳ [Enter]
Determines the selected item.
- ㉑ [Return]
Returns to the previous item/screen.

Operating an External DVD Changer

To operate an External DVD changer (Optional), set "Setting the Primary AUX Name (AUX Setup)" (page 44) or "Setting the Secondary AUX Name" (page 44) to "DVD-CHG."

Change to the External DVD Changer Mode

Touch **[DVD-CHG.]** of Top banner.

The display shows the DVD-CHG. mode screen.

About the DVD Changer Operation Screen

When the External DVD changer playback screen is displayed, you can touch the screen to display the operation screen. For details on how to operate, refer to the Owner's Manual of the connected DVD changer.

- *The DVD-CHG. operation mode screen and the Menu operation mode screen are the same as the external DVD player operation screen. Refer to "Operating an External DVD Player."*

External DVD changer display example

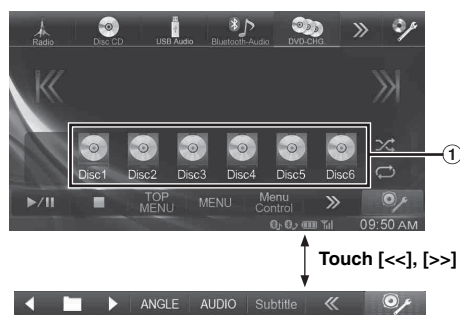

- ① [Disc1]-[Disc6]
Selects a Disc.

Operating the Mobile Digital TV Receiver (DVB-T)

To operate the Mobile Digital TV Receiver (DVB-T) (Optional), set "Setting the Primary AUX Name (AUX Setup)" (page 44) or "Setting the Secondary AUX Name" (page 44) to "DVB-T."

Changing to the Mobile Digital TV Receiver (DVB-T) Mode

Touch **[DVB-T]** of Top banner.

The display shows the DVB-T mode screen.

About the DVB-T Operation Screen

When you touch the screen in the DVB-T mode, the operation screen is displayed. For details on how to operate, refer to the Owner's Manual of the connected Digital TV Receiver (DVB-T).

Menu operation mode screen display example



- ① [**◀**]*
Switches the Channel number/ Favorite channel number down.
- ② [**▶**]*
Switches the Channel number / Favorite channel number up.
- ③ [TUNE] (Channel or FAV)
Switches between the Channel mode and the Favorite channel mode.
- ④ [EPG]
Call up the Electronic Programme Guide (EPG).
- ⑤ [MENU]
Call up the menu screen.
- ⑥ [Menu Control]
Call up the menu operation mode.
- ⑦ [A/V]
Switches the source.
- ⑧ [SCAN]
Touch the switch to start the scan procedure.

* The **◀◀**, **▶▶** buttons provide the same functions above.

- *If the setting for "Setting Direct Touch Operation" (page 44) is set to "On," direct touch operation is possible. Directly touch operation switches displayed on the screen to operate. To display the operation screen, touch [Control].*

Operating a TV

To operate a TV Receiver (TV) (Optional), set “Setting the Primary AUX Name (AUX Setup)” (page 44) or “Setting the Secondary AUX Name” (page 44) to “TV.”

Change to the TV mode

Touch **[TV]** of Top banner.

The display shows the TV mode screen.

About the TV Operation Screen

When the TV playback screen is displayed, you can touch the screen to display the operation screen. For details on how to operate, refer to the Owner’s Manual of the connected TV.



- ① [**◀**]*, [**⏪**]*
Switches the Channel number / Preset channel / frequency down.
- ② [**▶**]*, [**⏩**]*
Switches the Channel number / Preset channel / frequency up.
- ③ [TUNE] (Channel or PRESET or MANUAL)
Switches amongst Channel mode, Preset mode, and Manual mode.
- ④ [Band]
Switches the band.
- ⑤ [A.Memo]
The tuner automatically seeks and stores stations.

* The **◀◀**, **▶▶** buttons provide the same functions above.

Operating a USB Player or DAB/DAB+ TUNER

To operate a USB Player or DAB/DAB+ TUNER (Optional), set “Setting the Primary AUX Name (AUX Setup)” (page 44) or “Setting the Secondary AUX Name” (page 44) to “USB-PLAYER” or “DAB.” For details on how to operate, refer to the Owner’s Manual of the connected device.

Change to the USB-PLAYER or DAB/DAB+ Mode

Touch **[USB-PLAYER]** or **[DAB]** of Top banner.

The display shows the USB Player or DAB mode screen.

- The operation screen changes to the visual screen in the AUX mode for 5 seconds after an operation has been performed. To hide the AUX operation screen, touch the display area.
- Directly touch operation switches displayed on the screen to operate. To display the top banner, touch **[Control]**.

Applying TuneIt

This unit's sound tuning is programmable from a connected Smartphone. It is also possible to download specific parameters for certain vehicles from Alpine's TuneIt database stored in the Cloud. Using the TuneIt App, customized parameters can also be uploaded for others to share and rate.

Through this unit, it is also possible to receive and respond to information from Alpine's Social Network Service (SNS) available through the connected Smartphone.

The installed TuneIt App should be launched on the Smartphone before connection to the head unit.

TuneIt, is downloadable from Apple's App Store; the Android user can download it from Google Play. For details, consult your Alpine dealer.

- The application program and related specifications and data may be deleted or terminated without notice.
- Some TuneIt functions may not be available if the Smartphone is not in a service area or receives no signal.

Launching TuneIt App.

Launch TuneIt App on the smartphone.

The Notification List icon on the Top banner of this unit becomes effective and the indicator lights up.

Notification List icon



Indicator

- Before using these operations, set the App connection method to USB (iPhone) or Bluetooth (Android), depending on the connected Smartphone. For details, refer to "Setting the App Connection Method" (page 44).
- Using the TuneIt App, you can download the optimal BASS ENGINE SQ tuning data for your speaker system.

Facebook Notification Function

- Depending on the paired Smartphone, the following functions may not be available even though the TuneIt version is updated.

When the smartphone connected to the unit receives new notifications from Facebook, the unit emits a notification sound or displays the notification screen, according to the TuneIt App settings.

Display example of notification for the Audio/Visual screen



Poster's name

- If no operation is made within 5 seconds after displaying the notification screen or if you touch the Audio/Visual screen, the notification screen will disappear.

Checking the content of notification

Touch the poster's name on the notification screen or on the Notification List screen, to display the content of the notification.

Example of the Notification Details display

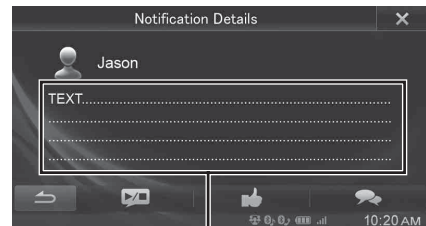

Content of notification

- You cannot check the content of a notification while the car is moving.

Displaying the Notification List

Touch the Notification List icon on the Top banner, or  (List) of the notification display.

■ Example of the Notification List display

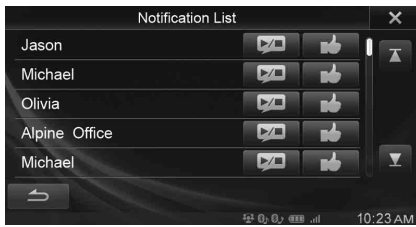

- If there are no notifications in the Notification List, "No Notifications." is displayed.

■ Other operations

 TTS (Text To Speech) Start/Stop switch

 Like switch:

The Smartphone feeds back a "Like" to Facebook while the received Wall Posts or Comments are played back by TTS (Text To Speech).

- As of February, 2014, the TTS correspondence App of iOS is chargeable, and the TTS non-correspondence App of iOS is distributed at no charge.

Camera Operation (Optional)

When an optional camera is connected, the view video of camera can be output to the monitor.

Depending on your camera, please choose the camera type first. For details, refer to “Camera Setup” (page 47).

Rear camera:

If an HCE-C305R*/HCE-C300R*/HCE-C200R/HCE-C115/HCE-C105 camera is connected, when the vehicle is reversed, the rear camera view (guide marks for vehicle width and available distance) is displayed automatically on the screen of this unit.

* When connecting to HCE-C305R/HCE-C300R, calibration must be performed. For details, refer to “Calibration” in the owner’s manual of HCE-C305R/HCE-C300R.

You can adjust the quality of the camera image.
Setting items: Brightness / Color / Contrast
Refer to “Visual Setting” (page 31).

Rear Camera Operation

Set “Rear” for “AUX Camera Setting” (page 48).

Checking Rear Camera view

Touch [] of Top banner.

The Rear Camera view is displayed.

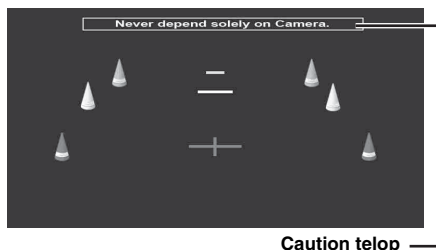

- Touch the screen to turn on the guide display.
- Touch the Caution telop to change the location of Caution.
- Press the **SOURCE/SOUND** button to close the camera display screen.

Displaying the Rear View Video while the Car is in Reverse

1 Shift the gear lever to the reverse (R) position.

The rear view image is displayed while the car remains in reverse.

2 If you shift the gear lever to a position other than reverse (R), the monitor returns to the previous screen.

- Never depend solely on the camera when backing up. Always turn and look and only use the camera for additional assistance.
- This function is effective when the reverse wire is properly connected.

USB Memory (Optional)

You can play back music files (MP3/WMA/AAC) and video files (DivX®) stored in a USB memory device on the internal player of this system. DivX® files stored in a USB memory device and protected by DRM (Digital Rights Management) cannot be played. This section explains music operations only. Refer to the DivX® operation section in “DVD” (page 23) for information on video.

- Some DivX files stored in a USB memory cannot be operated/played.
- If the first file played is a music file, the mode will be the music play mode. If the first file played is a video file, the mode will be the video play mode.

■ Display example for the USB main screen (Info mode)

Audio mode



Video mode

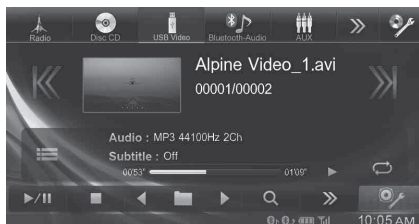

Touch [◀], [▶]



- Refer to “Display example for MP3/WMA/AAC main screen” (page 20) and “Display example for DivX® main screen” (page 23) for screen element explanations.
- You can display artwork during USB playback.

■ About creating a tag information library

You can scan music files in a USB memory device and create a library of tag information in this unit. Library creation starts when the USB memory device is connected. The time it takes to create the library depends on the number of files in the USB memory device, but it may take several minutes.

About operations during library creation

- “Tag Search” (page 66) does not work properly while a library is being created.
- The order in which songs are played during library creation may differ from the order in the USB memory device.

Playback

1 Touch [USB] of Top banner.

The USB mode is activated and the display changes to the USB screen.

2 Touch [⏮] or [⏭] or to select the desired track (file).

Returning to the beginning of the current track (file):

Touch [⏮].

Fast reverse :

Touch and hold [⏮].

Advancing to the beginning of the next track (file) :

Touch [⏭].

Fast forward :

Touch and hold [⏭].

- The [⏮], [⏭] buttons provide the same functions above.

3 To pause playback, touch [▶/⏸].

[▶] is displayed in the middle of the screen.

Touch [▶/⏸] again or touch [▶] in the middle of the screen to start playback.

- Any file protected by DRM (Digital Rights Management) copy protection, cannot be played back on this unit.
- The playback time may not be correctly displayed when a VBR (Variable Bit Rate) recorded file is played back.
- If there is tag information, artist name/album name/track name is displayed.
- ID3 tag/WMA tag
If an MP3/WMA/AAC file contains ID3 tag/WMA tag information, the ID3 tag/WMA tag information is displayed (e.g., song name, artist name, and album name).
- If the combined number of files/folders in the USB memory devices reaches 10,000, the message “The system has reached its limit of recognisable files/folders from the USB device.” will be displayed. To delete the message, remove the USB memory devices.

Repeat Play

Operation differs depending on whether the most recent song search was a Tag Search or a Folder/File Search.

Touch [↺] during playback.

The repeat mode switches every time the button is touched.

Folder/File Search mode:

Repeat → Repeat Folder* → (OFF) → Repeat



Tag Search mode:

Repeat → (OFF) → Repeat



* Only files in a folder are repeatedly played back.

- If the Repeat Play mode is activated during M.I.X. playback, the M.I.X. mode will be cancelled.

Random Play (M.I.X.)



Operation differs depending on whether the most recent song search was a Tag Search or a Folder Search.

Touch [∞] during playback.

The tracks (files) on the disc will be played back in a random sequence. To cancel M.I.X. play, touch [∞].



Folder Search mode:

M.I.X. Folder*¹ → (OFF) → M.I.X. Folder*¹

Tag Search mode:

M.I.X. Songs*² → (OFF) → M.I.X. Songs*²

*¹ Only files in a folder are played back in random sequence.

*² M.I.X. Songs randomly plays back songs within a selected category (playlist, album, etc.). The songs within the category are played just once until all songs have been played.

- If the M.I.X. mode is activated during Repeat playback, the Repeat Play mode will be cancelled.
- If you select a track by using the search mode, the M.I.X. play mode will be cancelled.

Random Play (Shuffle Songs)

This operation is available only if the most recent song search was a Tag Search.

1 Touch [Q (Search)] of Bottom banner during playback.

The Category List screen is displayed.

2 Touch [Shuffle Songs].

The tracks (files) on the disc will be played back in a random sequence.

To cancel Random play, touch [D].

- All songs in the USB memory are played back in random sequence. Any one song does not play back again until all songs have been played back.

Searching for a Desired Song

IVE-W585BT can carry out 2 kinds of searches.

- For details on Video file search, refer to “Searching for a Desired Video File” (page 26).

Touch [Q (Search)] of Bottom banner during playback.

The Category List screen is displayed.

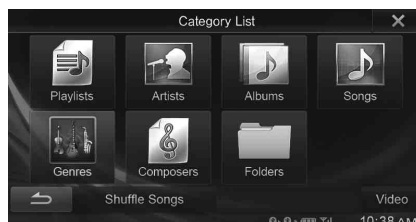

Tag Search

By using file tag information and keeping these songs organised in playlists, this unit's search functions will ease song searches in large libraries.

Each music category has its own individual hierarchy. Use the Playlists/Artists/Albums/Songs/Genres/Composers search mode to narrow searches based on the table below.

Hierarchy 1	Hierarchy 2	Hierarchy 3	Hierarchy 4
Playlists	Songs	—	—
Artists	Albums	Songs	—
Albums	Songs	—	—
Songs	—	—	—
Genres	Artists	Albums	Songs
Composers	Albums	Songs	—

For example: Searching by Artist name

The following example explains how an ARTISTS search is performed. Another search mode can be used for the same operation, although the hierarchy differs.

■ Searching by artist name

1 Touch [Artists].

The Artists search screen is displayed.

2 Select the desired artist.

To Play Back the Artist Directly

- 1 Touch [▶] of the artist's name.
All songs of the selected artist are played back.

To Search for the Album of the Artist

- 1 Touch the selected artist name.
The Albums search screen of the selected artist is displayed.
- 2 Touch [▶] of the desired album's name.
All songs of the selected album are played back.

To Search for a Song in the Album of the Artist

- 1 Touch the desired artist's name.
All albums of the selected artist are displayed.

3 Touch the desired album's name.

All songs of the selected album are displayed.

4 Touch the desired song's name.

The selected song is played back.

- For details on how to scroll through the list, refer to "Selecting an Item in a List" (page 16).
- After selecting a file via a Tag search, touch [] on the main screen to display the search screen. The hierarchy level you selected last in the search mode is displayed.

File/Folder Name Search

1 Touch [Folders].

The folder name list screen is displayed.

Folder Name Search Mode

2 Touch [▶] of the desired folder.

The first file in the selected folder is played back.



File Name Search Mode

2 Touch the desired folder name.

The file name of the selected folder is displayed.

3 Touch the desired file name.

The selected file is played back.

- To return to the previous hierarchy, touch [].
- For details on how to scroll through the list, refer to "Selecting an Item in a List" (page 16).
- After selecting a folder via a Folder name search, touch [] on the main screen to display the folder search screen.
- After selecting a file via a File name search, touch [] on the main screen to display the file search screen.

Direct Up/Down Function

This operation is available only if the most recent song search was a Tag Search.

Playlist/Artist/Album/Genre/Composer can be easily changed.

For example, if you listen to a song from a selected album, the album can be changed.

Touch [◀] or [▶] to select the desired Playlist/Artist/Album/Genre/Composer.

- If an album is selected from an artist search, the album can be searched.
- For details on icon display, refer to "Direct Up/Down switch icon:" (page 70).
- If search selection mode is not activated, Direct Up/Down Function is not possible.

Select the Desired Folder (Folder up/down)

This operation is available only if the most recent song search was a Folder/File Search.

If you listen to a file from a selected folder, the folder can be changed.

Touch [◀■] or [■▶] to select the folder.

- During M.I.X. ALL playback, this operation is not possible.

iPod/iPhone (Optional)

An iPod/iPhone can be connected to this unit by using the cable KCU-461iV (sold separately). You can connect a video-capable iPod to enjoy video as well as music.

When the IVE-W585BT is connected by the above cable, the controls on the iPod are disabled.

- *Internet or telephone functions, etc., of the iPhone or iPod touch are not controllable from the unit, but these functions can be controlled using the iPhone or iPod touch itself.*
- *To watch the video screen of the file in the iPod/iPhone, the parking brake must be engaged.*
- *For automatic transmission vehicles, place the transmission lever in the Park position.*

About iPod/iPhone models usable with this unit

- The following devices have been tested and shown to work with this unit. Correct function of earlier versions cannot be guaranteed.
 - iPod nano 6th generation 8GB/16GB: Ver.1.1
 - iPod touch 4th generation 8GB/32GB/64GB: Ver.4.3.1
 - iPod touch 3rd generation 32GB/64GB: Ver.4.3.1
 - iPod nano 5th generation(video camera) 8GB/16GB: Ver.1.0.2
 - iPod touch 2nd generation 8GB/16GB/32GB: Ver.4.2.1
 - iPod nano 4th generation(video) 8GB/16GB: Ver.1.0.4
 - iPod nano 3rd generation(video) 4GB/8GB: Ver.1.1.3
- The following devices have been tested and shown to work with this unit. Correct function of earlier versions cannot be guaranteed.
 - iPhone5S 16GB/32GB/64GB: Ver.7.0.4
 - iPhone5C 16GB/32GB: Ver.7.0.4
 - iPhone5 16GB/32GB/64GB: Ver.7.0.4
 - iPhone 4S 16GB/32GB/64GB: Ver.6.0.1
 - iPhone 4 16GB/32GB: Ver.4.3.1
 - iPhone 3GS 8GB/16GB/32GB: Ver.4.3.1
 - iPhone 3G 8GB/16GB: Ver.4.2.1
- For clarity in identifying your model of iPod, please see Apple's own document "Identifying iPod models" at <http://support.apple.com/kb/HT1353>.

WARNING

It is dangerous for the driver to watch video while driving the vehicle. The driver may be distracted from looking ahead and an accident could occur.

Install the IVE-W585BT correctly so that the driver cannot watch Video unless the vehicle is stopped and the emergency brake is applied.

If the IVE-W585BT is not installed correctly, the driver will be able to watch the Video while driving the vehicle and may be distracted from looking ahead causing an accident. The driver or other people could be severely injured.

■ Display example for iPod/iPhone main screen (Info mode)

Audio mode



Video mode



- ① Song title/Episode title*
- ② Artist title/Release Date*
- ③ Album title/Podcast title*
- ④ Current song no./Total song no.
- ⑤ Playing time
- ⑥ Artwork display

* Podcast mode

The iPod/iPhone operation screen display during video file playback

Touch the screen while the iPod/iPhone playback screen is displayed.

The iPod/iPhone operation screen is displayed.

- *The operation screen changes to the visual screen in the iPod mode for 5 seconds after an operation has been performed.*

Playback

1 Touch [iPod (Audio or Video)] of Top banner.

The display shows the iPod mode screen.

2 Touch [⏮] or [⏭] or to select the desired track (file).

Returning to the beginning of the current track (file):

Touch [⏮].

Fast reverse :

Touch and hold [⏮].

Advancing to the beginning of the next track (file) :

Touch [⏭].

Fast forward :

Touch and hold [⏭].

- The ⏮, ⏭ buttons provide the same functions above.

3 To pause playback, touch [▶/⏸].

- If a song is playing on the iPod/iPhone when it is connected to the IVE-W585BT, it will continue playing after the connection.
- If the artist, album or song name, created in iTunes, has too many characters, songs may not be played back when connected to the IVE-W585BT. Therefore, a maximum of 64 characters is recommended. The maximum number of characters for the unit is 64.
- Some characters may not be correctly displayed.

Searching for a Music File

An iPod/iPhone can contain thousands of songs. For this reason, this unit can make various searches using the search function as shown below.

Using the Playlist/Artist/Album/Podcast/Audiobook/Genre/Composer/Song search mode's individual hierarchy, you can narrow down your search as shown in the table below.

<MUSIC Search Menu>

Hierarchy 1	Hierarchy 2	Hierarchy 3	Hierarchy 4
Playlists	Songs	—	—
Artists	Albums	Songs	—
Albums	Songs	—	—
Songs	—	—	—
Podcasts	Episodes	—	—
Genres	Artists	Albums	Songs
Composers	Albums	Songs	—
Audiobooks	—	—	—

For example: Searching by Artist name

The following example explains how an ARTISTS search is performed. Another search mode can be used for the same operation, although the hierarchy differs.

■ Searching by artist name

1 Touch [🔍 (Search)] of Bottom banner during playback.

The Search screen is displayed.

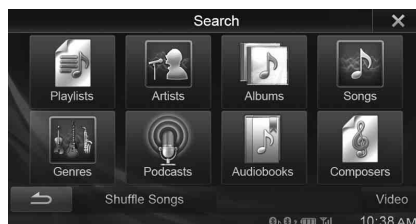

2 Touch [Artists].

The Artists search screen is displayed.

3 Select the desired artist.

To Play Back the Artist Directly

- 1 Touch [▶] of the artist's name.
All songs of the selected artist are played back.

To Search for the Album of the Artist

- 1 Touch the selected artist name.
The Albums search screen of the selected artist is displayed.
- 2 Touch [▶] of the desired album's name.
All songs of the selected album are played back.

To Search for a Song in the Album of the Artist

- 1 Touch the desired artist's name.
All albums of the selected artist are displayed.

4 Touch the desired album's name.

All songs of the selected album are displayed.

5 Touch the desired song's name.

The selected song is played back.

- Touching [▶] of "ALL" will play back all songs in the list.
- Touching "ALL" will display the search list in the next hierarchy.
- An alphabet skip function is available. Refer to "Alphabet Skip Function" (page 70).
- For details on how to scroll through the list, refer to "Selecting an Item in a List" (page 16).
- After selecting a file via a search, touch [☰] on the main screen to display the search screen. The hierarchy level you selected last in the search mode is displayed.

Searching for a Desired Video File

You can select a movie, music video, etc., from the list screen.

- *Video search mode depends on the iPod/iPhone. If the specification of the iPod/iPhone is changed, the search mode on this unit will also be changed.*

Examples for the video search mode

- Video Playlists
- Movies
- Music Videos, etc.

For example: Searching by Movie

The following example explains how a Movie search is performed. Another search mode can be used for the same operation, although the hierarchy differs.

1 Touch [🔍 (Search)] of Bottom banner during playback.

The Search screen is displayed.

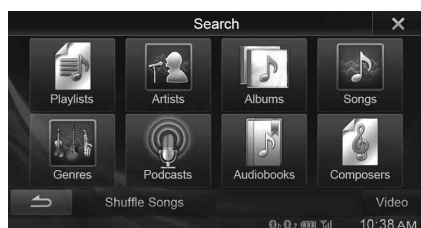

2 Touch [Video].

The Video search mode screen appears.

3 Touch [Movies].

The Movies search screen is displayed.

4 Touch the desired movie.

The selected movie is played back.

- *For details on how to scroll through the list, refer to “Selecting an Item in a List” (page 16).*
- *After selecting a file via a search, touch [☰] on the main screen to display the search screen. The hierarchy level you selected last in the search mode is displayed.*

Alphabet Skip Function

The unit is provided with an alphabet skip function for effective searching. When you use this function in the search mode, you can quickly search an artist or a song, etc.

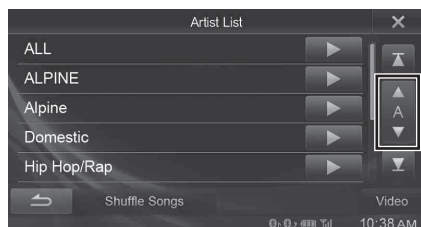

Alphabet skip function:

The alphabet skip function is skipped to the next alphabet such as from A to B, B to C by touching [ALPHABET ▼]. You can also skip in reverse order such as from B to A by touching [▲ ALPHABET].

Direct Up/Down Function

If you touch [▶] of the album name in the search mode, this album will be played back repeatedly. To go to the previous or next Album, use the Direct Up/Down Function.

Touch [◀] or [▶] to select the desired Playlist/Artist/Album/Genre/Podcast/Composer.



Direct Up/Down switch icon

Direct Up/Down switch icon:

	Playlist
	Artist
	Album
	Podcast
	Genre
	Composer

- *You can use the Direct Up/Down Function during video file playback. The Direct Up/Down Function switches in the video mode are [◀] [▶].*
- *If you are searching for a song, this operation cannot be performed.*
- *If an album is selected from an artist search, the album can be searched.*
- *During shuffle playback, this operation is not possible.*

Repeat Play

Touch [↺] to repeatedly play back the currently track.

The tracks (files) will be played repeatedly.

Touch [↺] again to deactivate Repeat play.

Repeat → (OFF) → Repeat

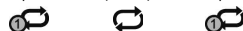

Random Play (Shuffle)

Touch [] during playback.

The files will be played back in a random sequence.

The Shuffle mode switches every time [] is touched.

Shuffle Songs → Shuffle Albums → (OFF) → Shuffle Songs



Shuffle Albums: The songs on each album are played back in proper order. Upon completing of all the songs on the album, the next album is selected randomly. This continues until all albums have been played.

Shuffle Songs: Song shuffle randomly plays back songs within a selected category (playlist, album, etc.). The songs within the category are played just once until all songs have been played.

- For details on the search mode, refer to “Searching for a Music File” (page 69).

Random Play (Shuffle Songs)

All files in the iPod are played back in random sequence.

1 Touch [ (Search)] of Bottom banner during playback.

2 Touch [Shuffle Songs].

The indicator “” lights, and the songs will be played back in random sequence.

To cancel Random play, touch [].

Information

Product Software Update

This product use software that can be updated through a USB memory device. Download the software from the Alpine website and update the product using the USB memory device.

Updating this product

Check the Alpine website for details on updating.

<http://www.alpine-europe.com>

About DVDs

Music CDs and DVDs have grooves (tracks) in which the digital data is recorded. The data is represented as microscopic pits recorded into the track – these pits are read by a laser beam to play the disc. On DVDs, the density of the tracks and pits is twice that of CDs, so DVDs can contain more data in less space.

CDs

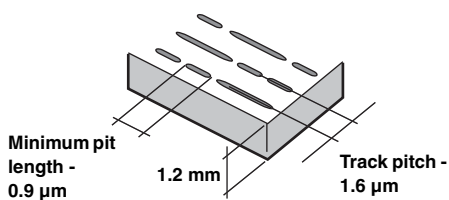

DVDs

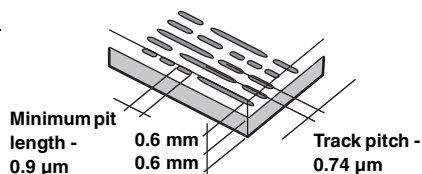

A 12 cm disc can contain one movie or about four hours of music. In addition, DVDs provide sharp picture quality with vivid colours thanks to a horizontal resolution of over 500 lines (compared to less than 300 for VHS tape).

In addition, DVDs offer a variety of functions.

Multiple audio* (page 27)

Movies can be recorded in up to eight languages. The desired language can be selected from the unit.

Subtitles function* (page 27)

Movies can include subtitles in up to 32 languages. The desired subtitle language can be selected from the unit.

Multi angle function* (page 27)

When the DVD contains a movie shot from multiple angles, the desired angle can be selected from the unit.

Multi story function*

With this function, a single movie includes various story lines. You can select different story lines to view various versions of the same movie.

Operation differs from disc to disc. Story line selection screens including instructions appear during the movie. Just follow the instructions.

* *These functions differ from disc to disc. For details, refer to the disc's instructions.*

List of Language Codes

(For details, see page 41.)

Abbreviation	Code	Language	Abbreviation	Code	Language	Abbreviation	Code	Language
AA	6565	Afar	IE	7369	Interlingue	RN	8278	Kirundi
AB	6566	Abkhazian	IK	7375	Inupiak	RO	8279	Romanian
AF	6570	Afrikaans	IN	7378	Indonesian	RU	8285	Russian
AM	6577	Amharic	IS	7383	Icelandic	RW	8287	Kinyarwanda
AR	6582	Arabic	IT	7384	Italian	SA	8365	Sanskrit
AS	6583	Assamese	IW	7387	Hebrew	SD	8368	Sindhi
AY	6589	Aymara	JP	7465	Japanese	SG	8371	Sangho
AZ	6590	Azerbaijani	JL	7473	Yiddish	SH	8372	Serbo-Croatian
BA	6665	Bashkir	JW	7487	Javanese	SI	8373	Singhalese
BE	6669	Byelorussian	KA	7565	Georgian	SK	8375	Slovak
BG	6671	Bulgarian	KK	7575	Kazakh	SL	8376	Slovenian
BH	6672	Bihari	KL	7576	Greenlandic	SM	8377	Samoan
BI	6673	Bislama	KM	7577	Cambodian	SN	8378	Shona
BN	6678	Bengali, Bangla	KN	7578	Kannada	SO	8379	Somali
BO	6679	Tibetan	KO	7579	Korean	SQ	8381	Albanian
BR	6682	Breton	KS	7583	Kashmiri	SR	8382	Serbian
CA	6765	Catalan	KU	7585	Kurdish	SS	8383	Siswati
CO	6779	Corsican	KY	7589	Kirghiz	ST	8384	Sesotho
CS	6783	Czech	LA	7665	Latin	SU	8385	Sundanese
CY	6789	Welsh	LN	7678	Lingala	SV	8386	Swedish
DA	6865	Danish	LO	7679	Laothian	SW	8387	Swahili
DE	6869	German	LT	7684	Lithuanian	TA	8465	Tamil
DZ	6890	Bhutani	LV	7686	Latvian, Lettish	TE	8469	Telugu
EL	6976	Greek	MG	7771	Malagasy	TG	8471	Tajik
EN	6978	English	MI	7773	Maori	TH	8472	Thai
EO	6979	Esperanto	MK	7775	Macedonian	TI	8473	Tigrinya
ES	6983	Spanish	ML	7776	Malayalam	TK	8475	Turkmen
ET	6984	Estonian	MN	7778	Mongolian	TL	8476	Tagalog
EU	6985	Basque	MO	7779	Moldavian	TN	8478	Setswana
FA	7065	Persian	MR	7782	Marathi	TO	8479	Tonga
FI	7073	Finnish	MS	7783	Malay	TR	8482	Turkish
FJ	7074	Fiji	MT	7784	Maltese	TS	8483	Tsonga
FO	7079	Faroese	MY	7789	Burmese	TT	8484	Tatar
FR	7082	French	NA	7865	Nauru	TW	8487	Twi
FY	7089	Frisian	NE	7869	Nepali	UK	8575	Ukrainian
GA	7165	Irish	NL	7876	Dutch	UR	8582	Urdu
GD	7168	Scots Gaelic	NO	7879	Norwegian	UZ	8590	Uzbek
GL	7176	Galician	OC	7967	Occitan	VI	8673	Vietnamese
GN	7178	Guarani	OM	7977	(Afan) Oromo	VO	8679	Volapuk
GU	7185	Gujarati	OR	7982	Oriya	WO	8779	Wolof
HA	7265	Hausa	PA	8065	Punjabi	XH	8872	Xhosa
HI	7273	Hindi	PL	8076	Polish	YO	8979	Yoruba
HR	7282	Croatian	PS	8083	Pashto, Pushto	ZH	9072	Chinese
HU	7285	Hungarian	PT	8084	Portuguese	ZU	9085	Zulu
HY	7289	Armenian	QU	8185	Quechua			
IA	7365	Interlingua	RM	8277	Rhaeto-Romance			

List of Country Codes

(For details, see page 42.)

Abbreviation	Code	Country	Abbreviation	Code	Country	Abbreviation	Code	Country
AD	6568	Andorra	DM	6877	Dominica	KI	7573	Kiribati
AE	6569	United Arab Emirates	DO	6879	Dominican Republic	KM	7577	Comoros
AF	6570	Afghanistan	DZ	6890	Algeria	KN	7578	Saint Kitts and Nevis
AG	6571	Antigua and Barbuda	EC	6967	Ecuador	KP	7580	Korea, Democratic People's Republic of
AI	6573	Anguilla	EE	6969	Estonia			
AL	6576	Albania	EG	6971	Egypt	KR	7582	Korea, Republic of
AM	6577	Armenia	EH	6972	Western Sahara	KW	7587	Kuwait
AN	6578	Netherlands Antilles	ER	6982	Eritrea	KY	7589	Cayman Islands
AO	6579	Angola	ES	6983	Spain	KZ	7590	Kazakhstan
AQ	6581	Antarctica	ET	6984	Ethiopia	LA	7665	Lao People's Democratic Republic
AR	6582	Argentina	FI	7073	Finland			
AS	6583	American Samoa	FJ	7074	Fiji	LB	7666	Lebanon
AT	6584	Austria	FK	7075	Falkland Islands	LC	7667	Saint Lucia
AU	6585	Australia	FM	7077	Micronesia, Federated States of	LI	7673	Liechtenstein
AW	6587	Aruba	FO	7079	Faroe Islands	LK	7675	Sri Lanka
AZ	6590	Azerbaijan	FR	7082	France	LR	7682	Liberia
BA	6665	Bosnia and Herzegovina	GA	7165	Gabon	LS	7683	Lesotho
BB	6666	Barbados	GB	7166	United Kingdom	LT	7684	Lithuania
BD	6668	Bangladesh	GD	7168	Grenada	LU	7685	Luxembourg
BE	6669	Belgium	GE	7169	Georgia	LV	7686	Latvia
BF	6670	Burkina Faso	GF	7170	French Guiana	LY	7689	Libyan Arab Jamahiriya
BG	6671	Bulgaria	GH	7172	Ghana	MA	7765	Morocco
BH	6672	Bahrain	GI	7173	Gibraltar	MC	7767	Monaco
BI	6673	Burundi	GL	7176	Greenland	MD	7768	Moldova, Republic of
BJ	6674	Benin	GM	7177	Gambia	MG	7771	Madagascar
BM	6677	Bermuda	GN	7178	Guinea	MH	7772	Marshall Islands
BN	6678	Brunei Darussalam	GP	7180	Guadeloupe	MK	7775	Macedonia, The former Yugoslav Republic of
BO	6679	Bolivia	GQ	7181	Equatorial Guinea			
BR	6682	Brazil	GR	7182	Greece	ML	7776	Mali
BS	6683	Bahamas	GS	7183	South Georgia and the South Sandwich Islands	MM	7777	Myanmar
BT	6684	Bhutan				MN	7778	Mongolia
BV	6686	Bouvet Island	GT	7184	Guatemala	MO	7779	Macau
BW	6687	Botswana	GU	7185	Guam	MP	7780	Northern Mariana Islands
BY	6689	Belarus	GW	7187	Guinea-Bissau	MQ	7781	Martinique
BZ	6690	Belize	GY	7189	Guyana	MR	7782	Mauritania
CA	6765	Canada	HK	7275	Hong Kong	MS	7783	Montserrat
CC	6767	Cocos (Keeling) Islands	HM	7277	Heard Island and McDonald Islands	MT	7784	Malta
CD	6768	Congo, the Democratic Republic of the				MU	7785	Mauritius
CF	6770	Central African Republic	HN	7278	Honduras	MV	7786	Maldives
CG	6771	Congo	HR	7282	Croatia	MW	7787	Malawi
CH	6772	Switzerland	HT	7284	Haiti	MX	7788	Mexico
CI	6773	Cote d'Ivoire	HU	7285	Hungary	MY	7789	Malaysia
CK	6775	Cook Islands	ID	7368	Indonesia	MZ	7790	Mozambique
CL	6776	Chile	IE	7369	Ireland	NA	7865	Namibia
CM	6777	Cameroon	IL	7376	Israel	NC	7867	New Caledonia
CN	6778	China	IN	7378	India	NE	7869	Niger
CO	6779	Colombia	IO	7379	British Indian Ocean Territory	NF	7870	Norfolk Island
CR	6782	Costa Rica	IQ	7381	Iraq	NG	7871	Nigeria
CU	6785	Cuba	IR	7382	Iran, Islamic Republic of	NI	7873	Nicaragua
CV	6786	Cape Verde	IS	7383	Iceland	NL	7876	Netherlands
CX	6788	Christmas Island	IT	7384	Italy	NO	7879	Norway
CY	6789	Cyprus	JM	7477	Jamaica	NP	7880	Nepal
CZ	6790	Czech Republic	JO	7479	Jordan	NR	7882	Nauru
DE	6869	Germany	JP	7480	Japan	NU	7885	Niue
DJ	6874	Djibouti	KE	7569	Kenya	NZ	7890	New Zealand
DK	6875	Denmark	KG	7571	Kyrgyzstan	OM	7977	Oman
			KH	7572	Cambodia	PA	8065	Panama

Abbreviation	Code	Country	Abbreviation	Code	Country	Abbreviation	Code	Country
PE	8069	Peru	SJ	8374	Svalbard and Jan Mayen	TW	8487	Taiwan, Province of China
PF	8070	French Polynesia	SK	8375	Slovakia	TZ	8490	Tanzania, United Republic of
PG	8071	Papua New Guinea	SL	8376	Sierra Leone	UA	8565	Ukraine
PH	8072	Philippines	SM	8377	San Marino	UG	8571	Uganda
PK	8075	Pakistan	SN	8378	Senegal	UM	8577	United States Minor Outlying Islands
PL	8076	Poland	SO	8379	Somalia	US	8583	United States
PM	8077	Saint Pierre and Miquelon	SR	8382	Suriname	UY	8589	Uruguay
PN	8078	Pitcairn	ST	8384	Sao Tome and Principe	UZ	8590	Uzbekistan
PR	8082	Puerto Rico	SV	8386	El Salvador	VA	8665	Holy See (Vatican City State)
PT	8084	Portugal	SY	8389	Syrian Arab Republic	VC	8667	Saint Vincent and the Grenadines
PW	8087	Palau	SZ	8390	Swaziland	VE	8669	Venezuela
PY	8089	Paraguay	TC	8467	Turks and Caicos Islands	VG	8671	Virgin Island, British
QA	8165	Qatar	TD	8468	Chad	VI	8673	Virgin Islands, U.S
RE	8269	Reunion	TF	8470	French Southern Territories	VN	8678	Viet Nam
RO	8279	Romania	TG	8471	Togo	VU	8685	Vanuatu
RU	8285	Russian Federation	TH	8472	Thailand	WF	8770	Wallis and Futuna
RW	8287	Rwanda	TJ	8474	Tajikistan	WS	8783	Samoa
SA	8365	Saudi Arabia	TK	8475	Tokelau	YE	8969	Yemen
SB	8366	Solomon Islands	TM	8477	Turkmenistan	YT	8984	Mayotte
SC	8367	Seychelles	TN	8478	Tunisia	YU	8985	Yugoslavia
SD	8368	Sudan	TO	8479	Tonga	ZA	9065	South Africa
SE	8369	Sweden	TP	8480	East Timor	ZM	9077	Zambia
SG	8371	Singapore	TR	8482	Turkey	ZW	9087	Zimbabwe
SH	8372	Saint Helena	TT	8484	Trinidad and Tobago			
SI	8373	Slovenia	TV	8486	Tuvalu			

In Case of Difficulty

If you encounter a problem, please turn the power off, then on again. If the unit is still not functioning normally, please review the items in the following checklist. This guide will help you isolate the problem if the unit is at fault. Otherwise, make sure the rest of your system is properly connected, or then consult your authorised Alpine dealer.

Basic

No function or display.

- Vehicle's ignition is off.
 - If connected according to the instructions, the unit will not operate with the vehicle's ignition off.
- Improper power lead connections.
 - Check power lead connections.
- Blown fuse.
 - Check the fuse on the battery lead of the unit; replace with the proper value if necessary.
- Internal micro-computer malfunctioned due to interference noise, etc.
 - Press the RESET switch with a ballpoint pen or other pointed article.

No sound or unnatural sound.

- Incorrect setting of volume/balance/fader controls.
 - Readjust the controls.
- Connections are not properly or securely made.
 - Check the connections and firmly connect.

Screen not displayed.

- Brightness/Contrast control is set at the minimum position.
 - Adjust the Brightness/Contrast control.
- Temperature in the vehicle is too low.
 - Increase the vehicle's interior temperature to operation temperature range.
- Connections to the DVD are not securely made.
 - Check the connections and firmly connect.
- The Parking Brake Lead is not connected.
- The Parking Brake is not engaged.
 - Connect the Parking Brake Lead, then engage the Parking Brake. (See page 86)

Movement of displayed picture is abnormal.

- Temperature in the vehicle is too high.
 - Allow the vehicle's interior temperature to cool.

Radio

Unable to receive stations.

- No antenna, or open connection in the antenna cable.
 - Make sure the antenna is properly connected; replace the antenna or cable if necessary.

Unable to tune stations in the seek mode.

- You are in a weak signal area.
 - Make sure the tuner is in DX mode.
- If the area you are in is a primary signal area, the antenna may not be grounded and connected properly.
 - Check your antenna connections; make sure the antenna is properly grounded at its mounting location.
- The antenna may not be the proper length.
 - Make sure the antenna is fully extended; if broken, replace the antenna with a new one.

Broadcast is noisy.

- The antenna is not the proper length.
 - Extend the antenna fully; replace it if it is broken.
- The antenna is poorly grounded.
 - Make sure the antenna is grounded properly at its mounting location.
- The station signal is weak and noisy.
 - If above solution does not work, tune in another station.

Disc

Disc playback sound is wavering.

- Moisture condensation in the disc Module.
 - Allow enough time for the condensation to evaporate (about 1 hour).

Disc insertion not possible.

- A disc is already in this unit.
 - Eject the disc and remove it.
- The disc is being improperly inserted.
 - Insert the disc correctly. (See page 14)

Unable to fast forward or backward the disc.

- The disc has been damaged.
 - Eject the disc and discard it; using a damaged disc in your unit can cause damage to the mechanism.

Disc playback sound skips due to vibration.

- Improper mounting of the unit.
 - Securely re-mount the unit.
- Disc is very dirty.
 - Clean the disc.
- Disc has scratches.
 - Change the disc.
- The pick-up lens is dirty.
 - Do not use a commercially available lens cleaner disc. Consult your nearest Alpine dealer.

Disc playback sound skips without vibration.

- Dirty or scratched disc.
 - Clean the disc; a damaged disc should be replaced.

CD-R/CD-RW/DVD-R/DVD-RW/DVD+R/DVD+RW playback not possible.

- Close session (finalisation) has not been performed.
 - Perform finalisation and attempt playback again.

Error displays.

- Mechanical error.
 - Press . After the error indication disappears, insert the disc again. If the above-mentioned solution does not solve the problem, consult your nearest Alpine dealer.

MP3/WMA/AAC is not played back.

- Writing error occurred. The CD format is not compatible.
 - Make sure the CD has been written in a supported format. Refer to "About MP3/WMA/AAC" (pages 21 to 22), then rewrite in the format supported by this device.

Unit does not operate.

- Condensation.
 - Wait a while (about 1 hour) for the condensation to dry.

Playback does not start.

- Disc is loaded upside-down.
 - Check the disc and load it with the labelled side facing upward.
- Disc is dirty.
 - Clean the disc.
- A disc not able to play back with this unit is loaded.
 - Check if the disc is able to be played back.
- Parental lock is set.
 - Cancel the parental lock or change the rating level.

Picture is unclear or noisy.

- Disc is being fast-forwarded or fast-reversed.
 - The picture may be slightly disturbed, but this is normal.
- Vehicle's battery power is weak.
 - Check the battery power and wiring.
(The unit may malfunction if the battery power is under 11 volts with a load applied.)

Image stops sometimes.

- Disc is scratched.
 - Replaced with a non-scratched disc.

If this Message Appears

Various messages are displayed on the screen during operation. In addition to the messages telling you the current status or providing guidance for the next operation, there are also the following error messages. If one of these error messages is displayed, carefully follow the instructions in the solution column.

System

USB current error.

- Abnormal current is run to the USB connector device.
 - Turn the ignition key off, and then set to ON again.
 - Attempt to connect another iPod/iPhone/USB memory device.

Unable to access the DVD drive.

The system will reset.

- An access error to DVD drive occurred for some reasons.
 - The unit is rebooted automatically.

Unable to access the DVD drive.

Please enquire details from the service center.

- An access error to DVD drive occurred for some reasons.
 - Please ask Service Centre for help.

Audio/Visual

Read error.

Please check the Disc.

- Scratched disc, contaminated disc/poor recording/disc incompatible with this unit.
 - Press ▲.
 - Change the disc.

USB device error.

- An iPod/iPhone that is not supported by the unit is connected.
 - Connect an iPod/iPhone that is supported by the unit.
 - Reset the iPod.
- A USB device that is not supported by the unit is connected.
 - Attempt to connect another USB memory device.
- Communication error.
 - Turn the ignition key off, and then set to ON again.
 - Check the display by reconnecting between the iPod/iPhone and the unit, using the iPod/iPhone cable.
 - Check the display by reconnecting between the USB memory device and the unit.
- Caused by the iPod/iPhone Software Version not being compatible with this unit.
 - Update the iPod/iPhone Software Version to be compatible with this unit.
- The iPod/iPhone is not verified.
 - Change another iPod/iPhone.

Region Code Violation.

- Disc does not match regional code number.
 - Load a disc that matches the regional code number.

No data.

- There are no data in the iPod/iPhone.
 - Download data to the iPod/iPhone and connect to the IVE-W585BT.
- There are no data in the USB memory.
 - Download data to the USB memory and connect to this unit.

Un-readable song was skipped.

- A copy-protected WMA file has been detected.
 - You can only play back non-copy-protected files.
- A sampling rate/bit rate not supported by the unit is used.
 - Use a sampling rate/bit rate supported by the unit.

BLUETOOTH

Please check BLUETOOTH audio device.

- The BLUETOOTH audio device was not connected correctly.
 - Check the settings for IVE-W585BT and the BLUETOOTH audio device and reconnect.

Please check mobile device.

- The mobile phone was not connected correctly.
 - Check the settings for IVE-W585BT and the mobile phone and reconnect.

Unable to download phonebook.

- Phonebook failed to read due to mobile phone disconnection, etc.
 - Check the mobile phone connection, and then conduct synchronising and adding again. (See page 54)
- The connected mobile phone does not support synchronising of its phone book.
 - Connect the mobile phone that supports synchronising the phone book, then synchronise again. (See page 54)

Playing back a DRM protected DivX File

Some operations cannot be performed while displaying the following message.

Authorization Error.

This player is not authorised to play this video.

- The version of the DRM protected DivX[®] File is not supported by this unit.
 - Play the supported DivX[®] File.
-

Rental Expired.

- The file being attempted to play has a limited number of viewings. The viewing limit has been reached and can no longer be played on this device. After the message has been displayed, the beginning of the next file will automatically be played back.
-

This DivX rental has used XX out of YY views.

Continue?

- If the total number of viewings for this file has not been exceeded, the views remaining is displayed.
 - To play back, select [**OK**]. If the next file is to be played back, select [**Cancel**].
-

Do you wish to stop playing rental file?

- While playing back a rental file, "Do you wish to stop playing rental file?" is displayed when the following operations are performed. Selecting [**OK**], reduces the number of views by 1.
 - Folder Up/Down
 - STOP
 - Search operation
 - Move to the first/last DivX[®] file by Chapter Up/Down
 - To interrupt the playback, touch [**OK**], or touch [**Cancel**] to not interrupt.
-

Audio format not supported.

- The file being played is a DivX[®] file with an unsupported audio format, so only the video data is played.
 - Play a DivX[®] file with a supported audio format.
-

Video frame rate not supported.

- The file being played is a DivX[®] file with an unsupported frame rate.
 - Play a DivX[®] file with a supported frame rate.
-

Video resolution not supported.

- The file being played is a DivX[®] file with an unsupported resolution.
 - Play a DivX[®] file with a supported resolution.
-

Specifications

MONITOR SECTION

Screen Size	6.1"
LCD Type	Transparent type TN LCD
Operation System	TFT active matrix
Number of Picture Elements	1,152,000 pcs. (800 × 3 × 480)
Effective Number of Picture Elements	99% or more
Illumination System	LED

FM TUNER SECTION

Tuning Range	87.5 – 108.0 MHz
Mono Usable Sensitivity	8.1 dBf (0.7 μ V/75 ohms)
50 dB Quieting Sensitivity	12 dBf (1.1 μ V/75 ohms)
Alternate Channel Selectivity	80 dB
Signal-to-Noise Ratio	65 dB
Stereo Separation	35 dB
Capture Ratio	2.0 dB

MW TUNER SECTION

Tuning Range	531 – 1,602 kHz
Usable Sensitivity	25.1 μ V/28 dBf

LW TUNER SECTION

Tuning Range	153 – 281 kHz
Sensitivity (IEC Standard)	31.6 μ V/30 dBf

USB SECTION

USB requirements	USB 1.1/2.0
Max. Power Consumption	1,000 mA
USB Class	USB (Play From Device)/ USB (Mass Storage Class)
File System	FAT16/32
MP3 Decoding	MPEG-1/2 AUDIO Layer-3
WMA Decoding	Windows Media™ Audio
AAC Decoding	AAC-LC format “.m4a” file
Number of Channels	2-Channel (Stereo)
Frequency Response*	5-20,000 Hz (\pm 1 dB)
Total Harmonic Distortion	0.008% (at 1 kHz)
Dynamic Range	95 dB (at 1 kHz)
Signal-to-Noise Ratio	100 dB
Channel Separation	85 dB (at 1 kHz)

* Frequency response may differ depending on the encoder software/bit rate.

CD/DVD SECTION

Frequency Response	5 – 20,000 Hz (\pm 1 dB)
Wow & Flutter (% WRMS)	Below measurable limits
Total Harmonic Distortion	0.008% (at 1 kHz)
Dynamic Range	95 dB (at 1 kHz)
Channel Separation	85 dB (at 1 kHz)
Signal system	NTSC/PAL
Horizontal resolution	500 lines or greater
Video output level	1Vp-p (75 ohms)
Video S/N ratio	DVD: 60 dB
Audio S/N ratio	100 dB

PICKUP

Wave length	DVD: 666 nm CD: 785 nm
Laser power	CLASS II

BLUETOOTH SECTION

BLUETOOTH Specification	Bluetooth V2.1+EDR
Output Power	+4 dBm Max. (Power class 2)
Profile	HFP (Hands-Free Profile) OPP (Object Push Profile) PBAP (Phone Book Access Profile) A2DP (Advanced Audio Distribution Profile) AVRCP (Audio/Video Remote Control Profile)

GENERAL

Power Requirement	14.4 V DC (11–16 V allowable)
Operating temperature	-20°C to + 60°C
Maximum Power Output	50 W × 4
Weight	2.25 kg
Audio output level	
Preout (Front, Rear):	4V/10k ohms (max.)
Preout (Subwoofer):	4V/10k ohms (max.)

CHASSIS SIZE

Width	178 mm
Height	100 mm
Depth	165 mm

NOSE SIZE

Width	170 mm
Height	96 mm
Depth	11.5 mm

- Due to continuous product improvement, specifications and design are subject to change without notice.
- The LCD panel is manufactured using an extremely high precision manufacturing technology. Its effective pixel ratio is over 99.99%. This means that there is a possibility that 0.01% of the pixels could be either always ON or OFF.

CAUTION



(Bottom side of player)

CAUTION-Laser radiation when open, DO NOT STARE INTO BEAM

(Bottom side of player)

END USER LICENSE AGREEMENT (Microsoft)

You have acquired a device ("DEVICE") that includes software licensed by Alpine Electronics, Inc. (collectively "ALPINE") from an affiliate of Microsoft Corporation (collectively "MS"). Those installed software products of MS origin, as well as associated media, printed materials, and "online" or electronic documentation ("SOFTWARE") are protected by international intellectual property laws and treaties. The SOFTWARE is licensed, not sold. All rights reserved.

IF YOU DO NOT AGREE TO THIS END USER LICENSE AGREEMENT ("EULA"), DO NOT USE THE DEVICE OR COPY THE SOFTWARE INSTEAD, PROMPTLY CONTACT ALPINE FOR INSTRUCTIONS ON RETURN OF THE UNUSED DEVICE(S) FOR A REFUND. ANY USE OF THE SOFTWARE, INCLUDING BUT NOT LIMITED TO USE ON THE DEVICE, WILL CONSTITUTE YOUR AGREEMENT TO THIS EULA (OR RATIFICATION OF ANY PREVIOUS CONSENT).

GRANT OF SOFTWARE LICENSE,

This EULA grants you the following license: You may use the SOFTWARE only on the DEVICE.

NOT FAULT TOLERANT.

THE SOFTWARE IS NOT FAULT TOLERANT. ALPINE HAS INDEPENDENTLY DETERMINED HOW TO USE THE SOFTWARE IN THE DEVICE, AND MS HAS RELIED UPON ALPINE TO CONDUCT SUFFICIENT TESTING TO DETERMINE THAT THE SOFTWARE IS SUITABLE FOR SUCH USE.

NO WARRANTIES FOR THE SOFTWARE,

THE SOFTWARE is provided "AS IS" and with all faults. THE ENTIRE RISK AS TO SATISFACTORY QUALITY, PERFORMANCE, ACCURACY, AND EFFORT (INCLUDING LACK OF NEGLIGENCE) IS WITH YOU. ALSO, THERE IS NO WARRANTY AGAINST INTERFERENCE WITH YOUR ENJOYMENT OF THE SOFTWARE OR AGAINST INFRINGEMENT. IF YOU HAVE RECEIVED ANY WARRANTIES REGARDING THE DEVICE OR SOFTWARE THOSE WARRANTIES DO NOT ORIGINATE FROM, AND ARE NOT BINDING ON, MS.

NO LIABILITY FOR CERTAIN DAMAGES.

EXCEPT AS PROHIBITED BY LAW, MS SHALL HAVE NO LIABILITY FOR ANY INDIRECT, SPECIAL, CONSEQUENTIAL OR THE SOFTWARE. THIS LIMITATION SHALL APPLY EVEN IF ANY REMEDY FAILS OF ITS ESSENTIAL PURPOSE. IN NO EVENT SHALL MS BE LIABLE FOR ANY AMOUNT IN EXCESS OF U.S. TWO HUNDRED FIFTY DOLLARS (U.S. \$250.00).

LIMITATIONS ON REVERSE ENGINEERING, DECOMPILATION, AND DISASSEMBLY

You may not reverse engineer, decompile, or disassemble the SOFTWARE, except and only to the extent that such activity is expressly permitted by applicable law notwithstanding this limitation.

ADDITIONAL SOFTWARE/SERVICES.

The SOFTWARE may permit ALPINE, MS, Microsoft Corporation or their affiliates to provide or make available to you SOFTWARE updates, supplements, add-on components, or Internet – base service components of the SOFTWARE after the date you obtain your initial copy of the SOFTWARE (“Supplemental Components”).

- If ALPINE provides or makes available to you Supplemental Components and no other EULA terms are provided along with the Supplemental Components, then the terms of this EULA shall apply.
- If MS, Microsoft Corporation or their affiliates make available Supplemental Components, and no other EULA terms are provided, then the terms of this EULA shall apply, except that MS, Microsoft Corporation or affiliate entity providing the Supplemental Component(s) shall be licensor of the Supplemental Component(s).
- ALPINE, MS, Microsoft Corporation and their affiliates reserve the right to discontinue any Internet-based services provided to you or made available to you through the use of the SOFTWARE.

RECOVERY MEDIA.

If SOFTWARE is provided by ALPINE on separate media and labelled “Recovery Media” you may use the Recovery Media solely to restore or reinstall the SOFTWARE originally installed on the DEVICE.

UPGRADES.

If the SOFTWARE is provided by ALPINE separate from the DEVICE on separate media or via web download or other means, and is labelled “For Upgrade Purposes Only” you may install one (1) copy of such SOFTWARE onto the DEVICE as a replacement copy for the existing SOFTWARE, and use it in accordance with this EULA, including any additional EULA terms accompanying the upgrade SOFTWARE.

TERMINATION.

Without prejudice to any other rights, ALPINE or MS may terminate this EULA if you fail to comply with the terms and conditions of this EULA. In such event, you must destroy all copies of the SOFTWARE and all of its component parts.

INTELLECTUAL PROPERTY RIGHTS.

All title and intellectual property rights in and to the SOFTWARE (including but not limited to any images, photographs, animations, video, audio, music, text and “applets,” incorporated into the SOFTWARE), the accompanying printed materials, and any copies of the SOFTWARE, are owned by MS, Microsoft Corporation, their affiliates or suppliers. The SOFTWARE is licensed, not sold.

You may not copy the printed materials accompanying the SOFTWARE. All title and intellectual property rights in and to the content which may be accessed through use of the SOFTWARE is the property of the respective content owner and may be protected by applicable copyright or other intellectual property laws and treaties. This EULA grants you no rights to use such content. All rights not specifically granted under this EULA are reserved by MS, Microsoft Corporation, their affiliates and suppliers. Use of any on-line services which may be accessed through the SOFTWARE may be governed by the respective terms of use relating to such services. If this SOFTWARE contains documentation that is provided only in electronic form, you may print one copy of such electronic documentation.

TRADEMARKS.

This EULA does not grant you any rights in connection with any trademarks or service marks of ALPINE, MS, Microsoft Corporation, their affiliates or suppliers.

PRODUCT SUPPORT.

Product support for the SOFTWARE is not provided by MS, its parent corporation Microsoft Corporation, or their affiliates or subsidiaries. For product support, please refer to ALPINE support number provided in the documentation for the DEVICE. Should you have any questions concerning this EULA, or if you desire to contact ALPINE for any other reason, please refer to the address provided in the documentation for the DEVICE.

SOFTWARE TRANSFER ALLOWED BUT WITH RESTRICTIONS.

You may permanently transfer rights under this EULA only as part of a permanent sale or transfer of the Device, and only if the recipient agrees to this EULA. If the SOFTWARE is an upgrade, any transfer must also include all prior versions of the SOFTWARE.

EXPORT RESTRICTION.

You acknowledge that SOFTWARE is of US-origin. You agree to comply with all applicable international and national laws that apply to the SOFTWARE, including the U.S. Export Administration Regulations, as well as end-user, end-use and country destination restrictions issued by U.S. and other governments. For additional information on exporting the SOFTWARE, see <http://www.microsoft.com/exporting/>

Installation and Connections

Before installing or connecting the unit, please read the following and pages 7 to 11 of this manual thoroughly for proper use.

Warning

MAKE THE CORRECT CONNECTIONS.

Failure to make the proper connections may result in fire or product damage.

USE ONLY IN CARS WITH A 12 VOLT NEGATIVE GROUND.

(Check with your dealer if you are not sure.) Failure to do so may result in fire, etc.

BEFORE WIRING, DISCONNECT THE CABLE FROM THE NEGATIVE BATTERY TERMINAL.

Failure to do so may result in electric shock or injury due to electrical shorts.

DO NOT ALLOW CABLES TO BECOME ENTANGLED IN SURROUNDING OBJECTS.

Arrange wiring and cables in compliance with the manual to prevent obstructions when driving. Cables or wiring that obstruct or hang up on places such as the steering wheel, gear lever, brake pedals, etc. can be extremely hazardous.

DO NOT SPLICE INTO ELECTRICAL CABLES.

Never cut away cable insulation to supply power to other equipment. Doing so will exceed the current carrying capacity of the wire and result in fire or electric shock.

DO NOT DAMAGE PIPE OR WIRING WHEN DRILLING HOLES.

When drilling holes in the chassis for installation, take precautions so as not to contact, damage or obstruct pipes, fuel lines, tanks or electrical wiring. Failure to take such precautions may result in fire.

DO NOT USE BOLTS OR NUTS IN THE BRAKE OR STEERING SYSTEMS TO MAKE GROUND CONNECTIONS.

Bolts or nuts used for the brake or steering systems (or any other safety-related system), or tanks should NEVER be used for installations or ground connections. Using such parts could disable control of the vehicle and cause fire etc.

KEEP SMALL OBJECTS SUCH AS SCREWS OUT OF THE REACH OF CHILDREN.

Swallowing them may result in serious injury. If swallowed, consult a physician immediately.

DO NOT INSTALL IN LOCATIONS WHICH MIGHT HINDER VEHICLE OPERATION, SUCH AS THE STEERING WHEEL OR SHIFT LEVER.

Doing so may obstruct forward vision or hamper movement etc. and results in serious accident.

Caution

HAVE THE WIRING AND INSTALLATION DONE BY EXPERTS.

The wiring and installation of this unit requires special technical skill and experience. To ensure safety, always contact the dealer where you purchased this product to have the work done.

USE SPECIFIED ACCESSORY PARTS AND INSTALL THEM SECURELY.

Be sure to use only the specified accessory parts. Use of other than designated parts may damage this unit internally or may not securely install the unit in place. This may cause parts to become loose resulting in hazards or product failure.

ARRANGE THE WIRING SO IT IS NOT CRIMPED OR PINCHED BY A SHARP METAL EDGE.

Route the cables and wiring away from moving parts (like the seat rails) or sharp or pointed edges. This will prevent crimping and damage to the wiring. If wiring passes through a hole in metal, use a rubber grommet to prevent the wire's insulation from being cut by the metal edge of the hole.

DO NOT INSTALL IN LOCATIONS WITH HIGH MOISTURE OR DUST.

Avoid installing the unit in locations with high incidence of moisture or dust. Moisture or dust that penetrates into this unit may result in product failure.

Precautions

- Be sure to disconnect the cable from the (-) battery post before installing your IVE-W585BT. This will reduce any chance of damage to the unit in case of a short-circuit.
- Be sure to connect the colour coded leads according to the diagram. Incorrect connections may cause the unit to malfunction or damage to the vehicle's electrical system.
- When making connections to the vehicle's electrical system, be aware of the factory installed components (e.g. on-board computer). Do not tap into these leads to provide power for this unit. When connecting the IVE-W585BT to the fuse box, make sure the fuse for the intended circuit of the IVE-W585BT has the appropriate amperage. Failure to do so may result in damage to the unit and/or the vehicle. When in doubt, consult your Alpine dealer.
- The IVE-W585BT uses female RCA-type jacks for connection to other units (e.g. amplifier) having RCA connectors. You may need an adaptor to connect other units. If so, please contact your authorised Alpine dealer for assistance.
- Be sure to connect the speaker (-) leads to the speaker (-) terminal. Never connect left and right channel speaker cables to each other or to the vehicle body.

IMPORTANT

Please record the serial number of your unit in the space provided below and keep it as a permanent record. The serial number plate is located on the bottom of the unit.

SERIAL NUMBER: _____

INSTALLATION DATE: _____

INSTALLATION TECHNICIAN: _____

PLACE OF PURCHASE: _____

Installation

Caution

Do not block the unit's fan or heat sink, thus preventing air circulation. If blocked, heat will accumulate inside the unit and may cause a fire.

<example>

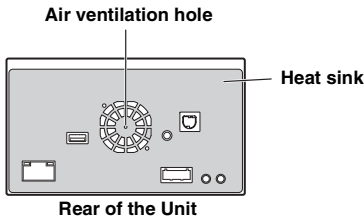

Caution concerning the installation location

1 Angle of installation

Install at an angle between horizontal and 30°. Note that installing at an angle outside of this range will result in a loss of performance and possibly damage.

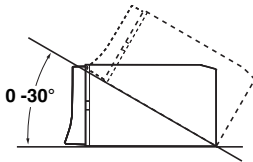

2 Mounting the Microphone.

For safe use, make sure of the following:

- location is stable and firm.
- driver's view and operations are not obstructed.
- microphone is located where the driver's voice can be easily picked up (on the sun visor, etc.).

When you speak into the microphone, you should not have to change your driving posture. This may cause a distraction, taking your attention away from safely driving your vehicle. Carefully consider direction and distance while mounting the microphone. Confirm that the driver's voice can be easily picked up at the selected location.

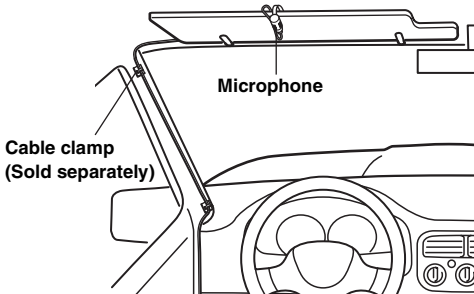

- 3 Remove the mounting sleeve from the main unit (see "Removal" on page 84). Slide the unit into the mounting sleeve and secure it.

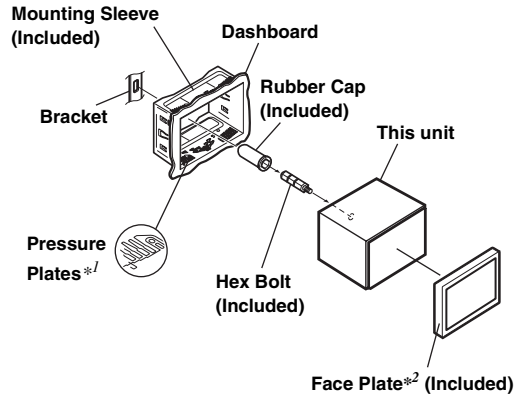

*1 If the installed mounting sleeve is loose in the dashboard, the pressure plates may be bent slightly to remedy the problem.

*2 The supplied face plate may be mounted.

- 4 When your vehicle has the Bracket, mount the long hex bolt onto the rear panel of the IVE-W585BT and put the Rubber Cap on the hex bolt. If your vehicle does not have the Mounting Support, reinforce the head unit with the metal mounting strap (not supplied). Secure the ground lead of the unit to a clean metal spot using a screw (*1) already attached to the vehicle's chassis. Connect all the leads of the IVE-W585BT according to details described in the CONNECTION section.

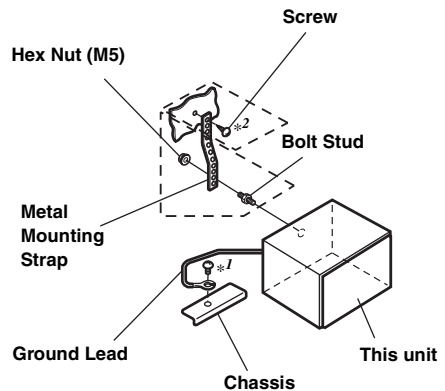

- For the screw marked "*2," use an appropriate screw for the chosen mounting location.

- 5** Slide the IVE-W585BT into the dashboard until it clicks. This ensures that the unit is properly locked and will not accidentally come out from the dashboard.

Removal

1. Insert the bracket keys into the unit, along the guides on either side. The unit can now be removed from the mounting sleeve.

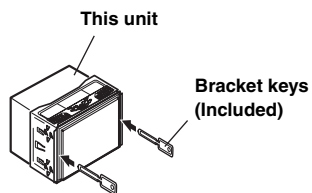

2. Pull the unit out, keeping it unlocked as you do so.

Connection Diagram of SPST Switch (sold separately)

(If the ACC power supply is not available)

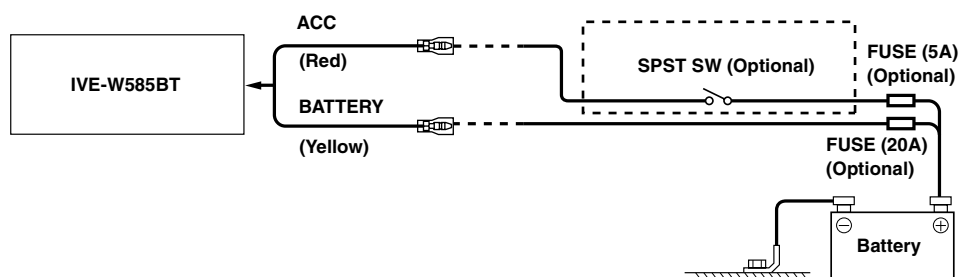

- If your vehicle has no ACC power supply, add an SPST (Single-Pole, Single-Throw) switch (sold separately) and fuse (sold separately).
- The diagram and the fuse amperage shown above are in the case when IVE-W585BT is used individually.
- If the switched power (ignition) lead of the IVE-W585BT is connected directly to the positive (+) post of the vehicle's battery, the IVE-W585BT draws some current (several hundred milliamperes) even when its switch is placed in the OFF position, and the battery may be discharged.

To prevent external noise from entering the audio system.

- Locate the unit and route the leads at least 10 cm away from the car harness.
- Keep the battery power leads as far away from other leads as possible.
- Connect the ground lead securely to a bare metal spot (remove any paint, dirt or grease if necessary) of the car chassis.
- If you add an optional noise suppressor, connect it as far away from the unit as possible. Your Alpine dealer carries various noise suppressors, contact them for further information.
- Your Alpine dealer knows best about noise prevention measures so consult your dealer for further information.

Connections

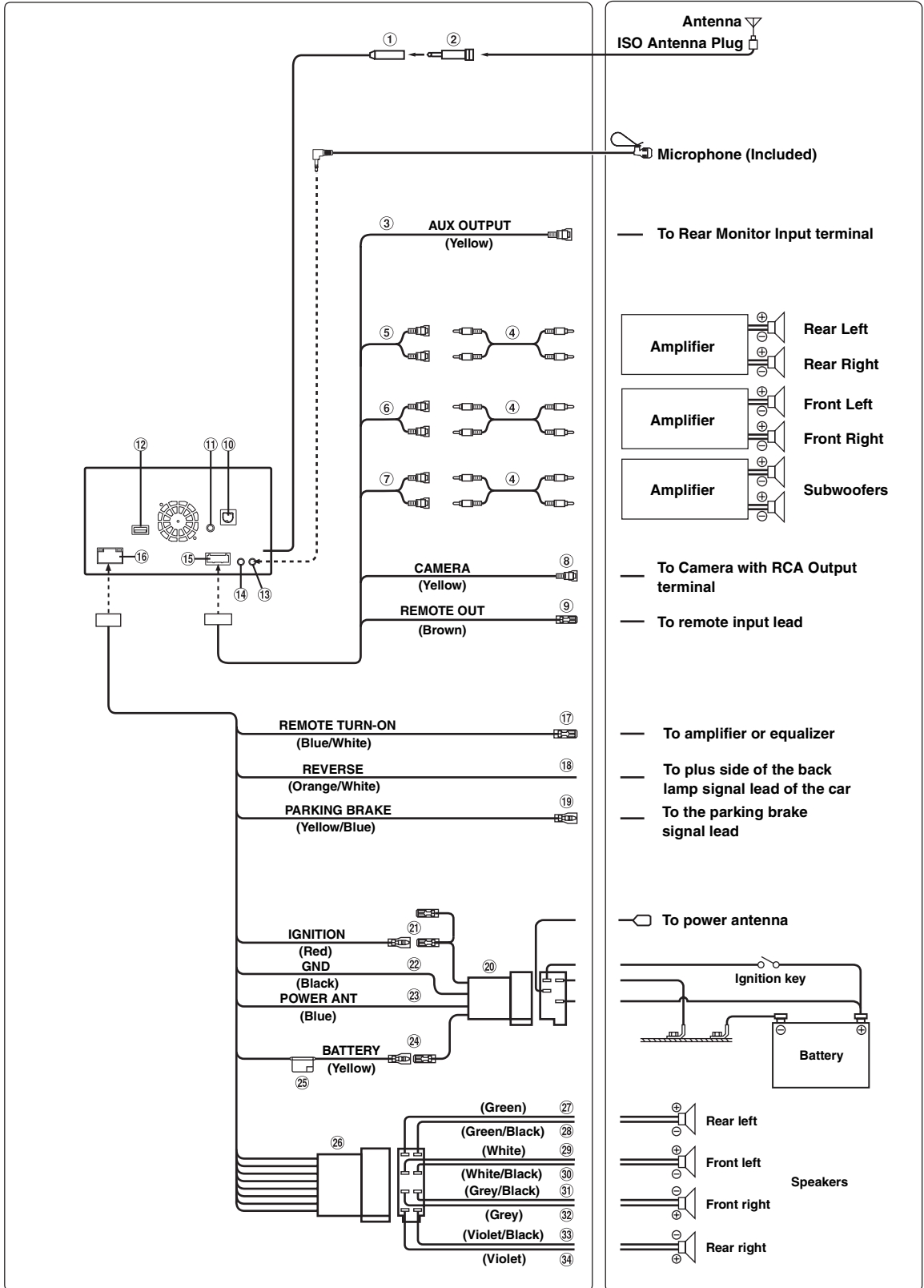

- ① **Radio Antenna Receptacle**
- ② **ISO/JASO Antenna Adapter (sold separately)**
ISO/JASO Antenna Adapter may be required, depending on the vehicle.
- ③ **Video Output Connector (AUX OUTPUT) (Yellow)**
- ④ **RCA Extension Cable (sold separately)**
- ⑤ **Rear Output RCA Connectors**
It can be used as Rear Output RCA Connectors. RED is right and WHITE is left.
- ⑥ **Front Output RCA Connectors**
It can be used as Front Output RCA Connectors. RED is right and WHITE is left.
- ⑦ **Subwoofer RCA Connectors**
RED is right and WHITE is left.
- ⑧ **CAMERA Input RCA Connector (CAMERA) (Yellow)**
Use when connecting a camera with RCA Output Connector.
- ⑨ **Remote Control Output Lead (Brown)**
Connect this lead to the remote control input lead. This lead outputs the controlling signals from the remote control.
- ⑩ **Vehicle Display Interface Connector**
Outputs Vehicle Display Interface control signals. Connect this to the optional Vehicle Display Interface box.
For details about connections, consult your nearest Alpine dealer.
- ⑪ **iPod VIDEO Input Connector**
Input the iPod/ iPhone video signal or AUX video/audio signal.
 - Set "AUX In" (page 44) to "iPod Video" when an iPod/ iPhone is connected.
 - Set "AUX In" (page 44) to "AUX" when AUX video/audio is input.
- ⑫ **USB Connector**
To USB Memory or iPod/iPhone or Nokia Phone.
- ⑬ **MIC Input Connector**
To Microphone (Included).
- ⑭ **Steering Remote Control Interface Connector**
To steering remote control interface box.
For details about connections, consult your nearest Alpine dealer.
- ⑮ **AUX/PREOUT Connector**
- ⑯ **Power Supply Connector**
- ⑰ **Remote Turn-On Lead (Blue/White)**
Connect this lead to the remote turn-on lead of your amplifier or signal processor.
- ⑱ **Reverse Lead (Orange/White)**
Connect to the plus side of the car's reverse lamp. This lamp illuminates when the transmission is shifted into reverse (R).
With this lead properly wired, the video picture automatically switches to the rear camera whenever the car is put into reverse (R).
- ⑲ **Parking Brake Lead (Yellow/Blue)**
Connect this lead to the power supply side of the parking brake switch to transmit the parking brake status signals to the IVE-W585BT.
- ⑳ **ISO Power Supply Connector**
- ㉑ **Switched Power Lead (Ignition) (Red)**
Connect this lead to an open terminal on the vehicle's fuse box or another unused power source which provides (+) 12V only when the ignition is turned on or in the accessory position.
- ㉒ **Ground Lead (Black)**
Connect this lead to a good chassis ground on the vehicle. Make sure the connection is made to bare metal and is securely fastened using the sheet metal screw provided.
- ㉓ **Power Antenna Lead (Blue)**
Connect this lead to the +B terminal of your power antenna, if applicable.
This lead should be used only for controlling the vehicle's power antenna. Do not use this lead to turn on an amplifier or a signal processor, etc.
- ㉔ **Battery Lead (Yellow)**
Connect this lead to the positive (+) post of the vehicle's battery.
- ㉕ **Fuse Holder (15A)**
- ㉖ **ISO Connector (Speaker Output)**
- ㉗ **Left Rear (+) Speaker Output Lead (Green)**
- ㉘ **Left Rear (-) Speaker Output Lead (Green/Black)**
- ㉙ **Left Front (+) Speaker Output Lead (White)**
- ㉚ **Left Front (-) Speaker Output Lead (White/Black)**
- ㉛ **Right Front (-) Speaker Output Lead (Grey/Black)**
- ㉜ **Right Front (+) Speaker Output Lead (Grey)**
- ㉝ **Right Rear (-) Speaker Output Lead (Violet/Black)**
- ㉞ **Right Rear (+) Speaker Output Lead (Violet)**

System Example

Connection of an iPod/iPhone or USB memory

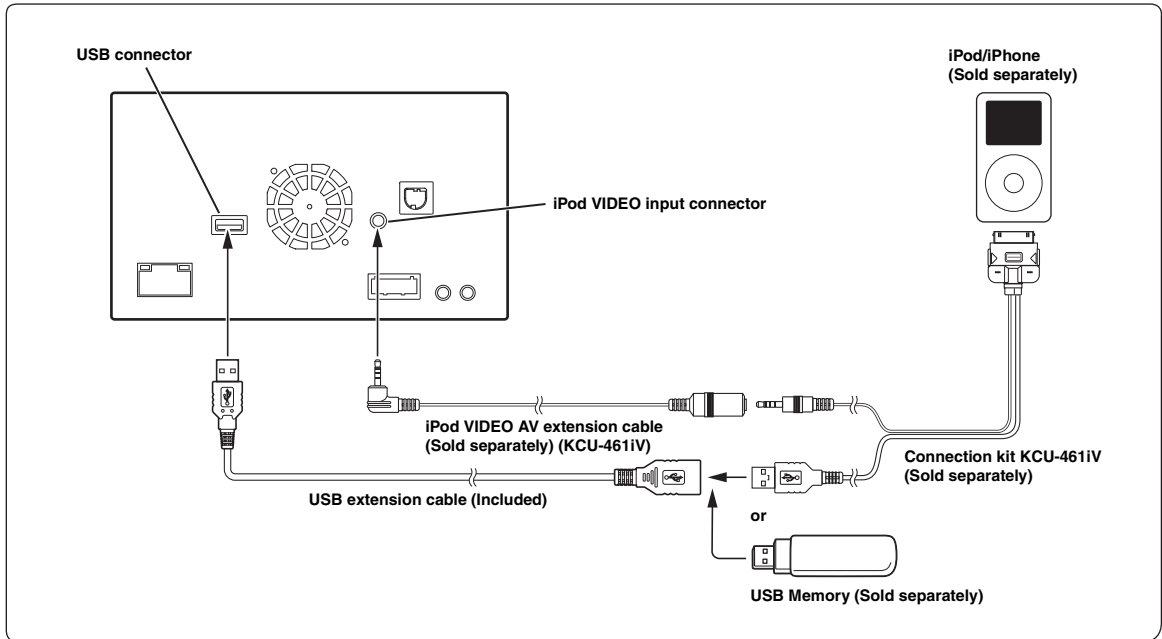

- Do not leave a iPod/iPhone/USB memory in a vehicle for a long time. Heat and humidity may damage the iPod/iPhone/USB memory and you may not be able to play it again.

Connection of a Rear Monitor

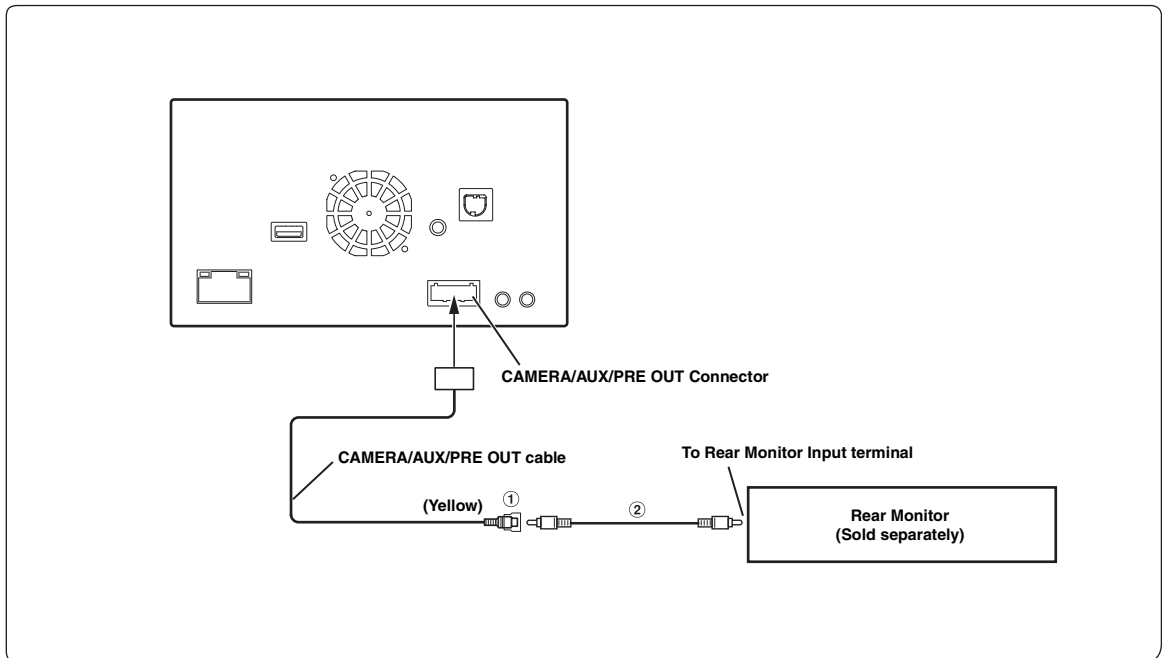

- ① Video Output Connector (AUX OUTPUT)
- ② RCA Extension Cable (Sold Separately)

Connection of an External device

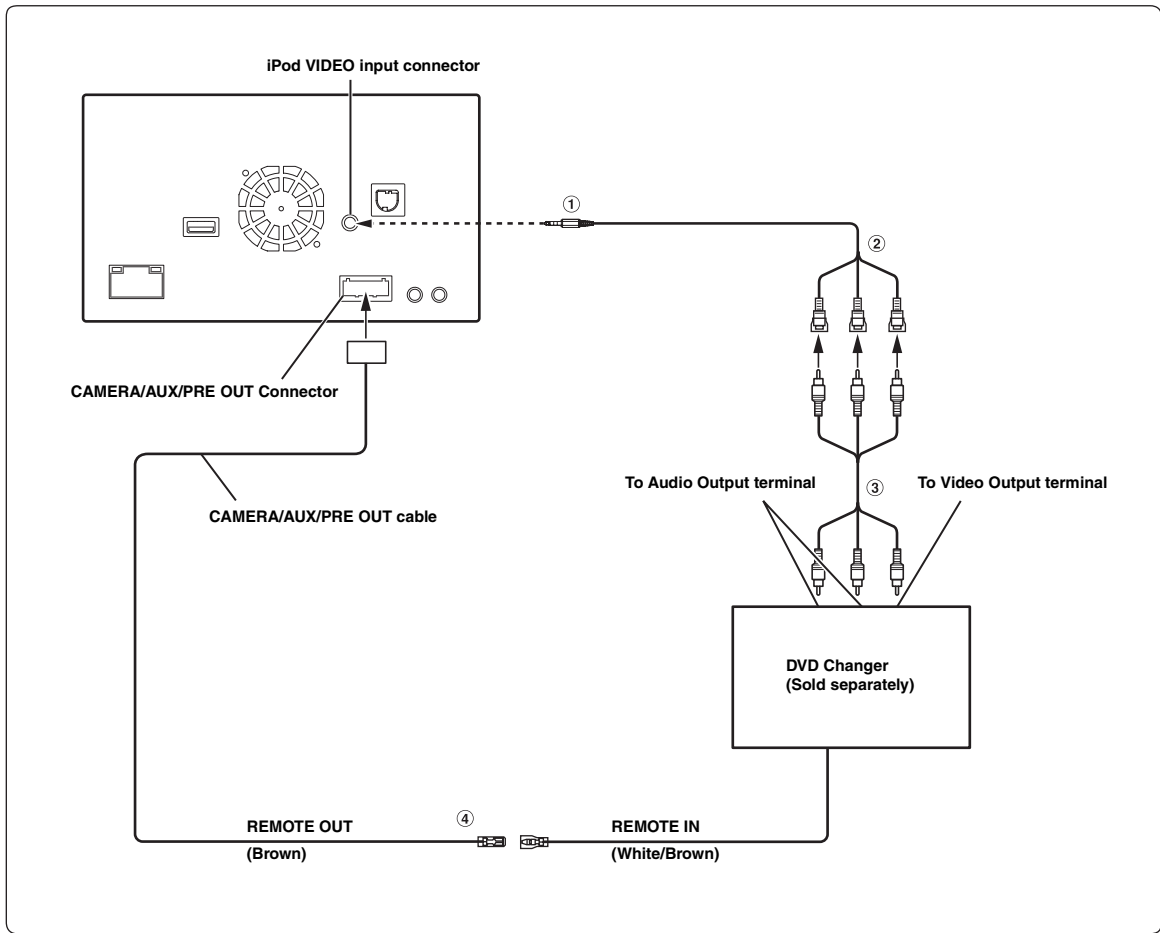

① **AV/RCA interface cable (4-pole mini AV plug to 3-RCA) (sold separately)**

② **Video/Audio Input Connectors (AUX INPUT)**
YELLOW is for input video, RED is right and WHITE is left input the audio.

③ **RCA Extension Cable (Sold Separately)**

④ **Remote Control Output Lead (Brown)**
Connect this lead to the remote control input lead. This lead outputs the controlling signals from the remote control.

- To connect an external input device to the iPod VIDEO connector, set "AUX In" to "AUX." Refer to "Setting the AUX Mode" (page 44).
- You can change the name of an external device. Refer to "Setting the AUX Mode" (page 44).

Connection of a DVD Player

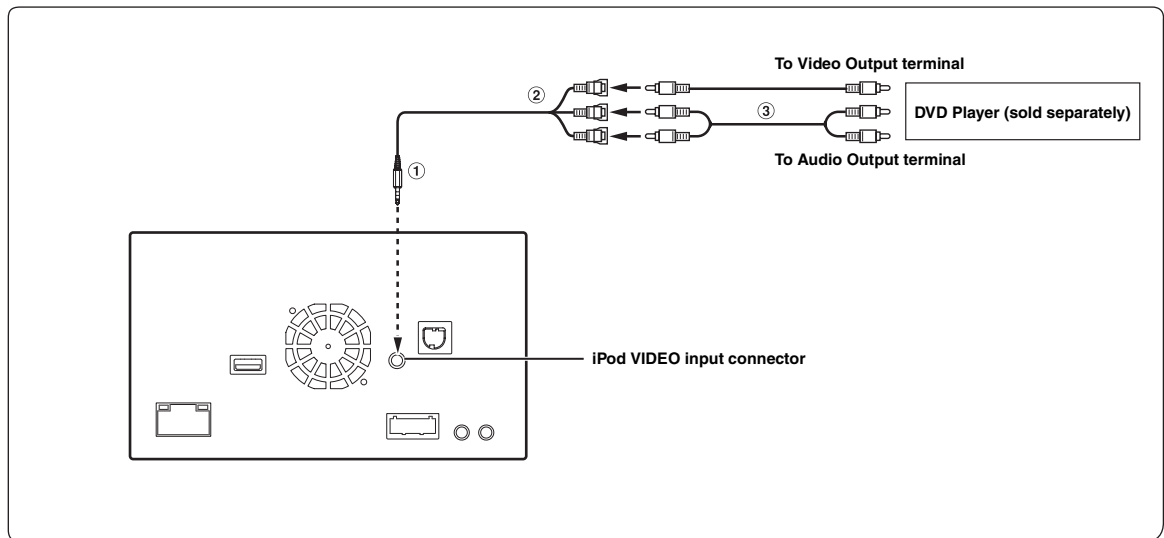

① **AV/RCA interface cable (4-pole mini AV plug to 3-RCA) (sold separately)**

③ **RCA Extension Cable (Sold Separately)**

② **Video/Audio Input Connectors**

YELLOW is for input video, RED is right and WHITE is left input the audio.

- You can change the name of an external device. Refer to "Setting the AUX Mode" (page 44).
- To connect an external input device to the iPod VIDEO connector, set "AUX In" to "AUX." Refer to "Setting the AUX Mode" (page 44).

Connection of a Mobile Digital TV Receiver/USB Player and DVD Changer

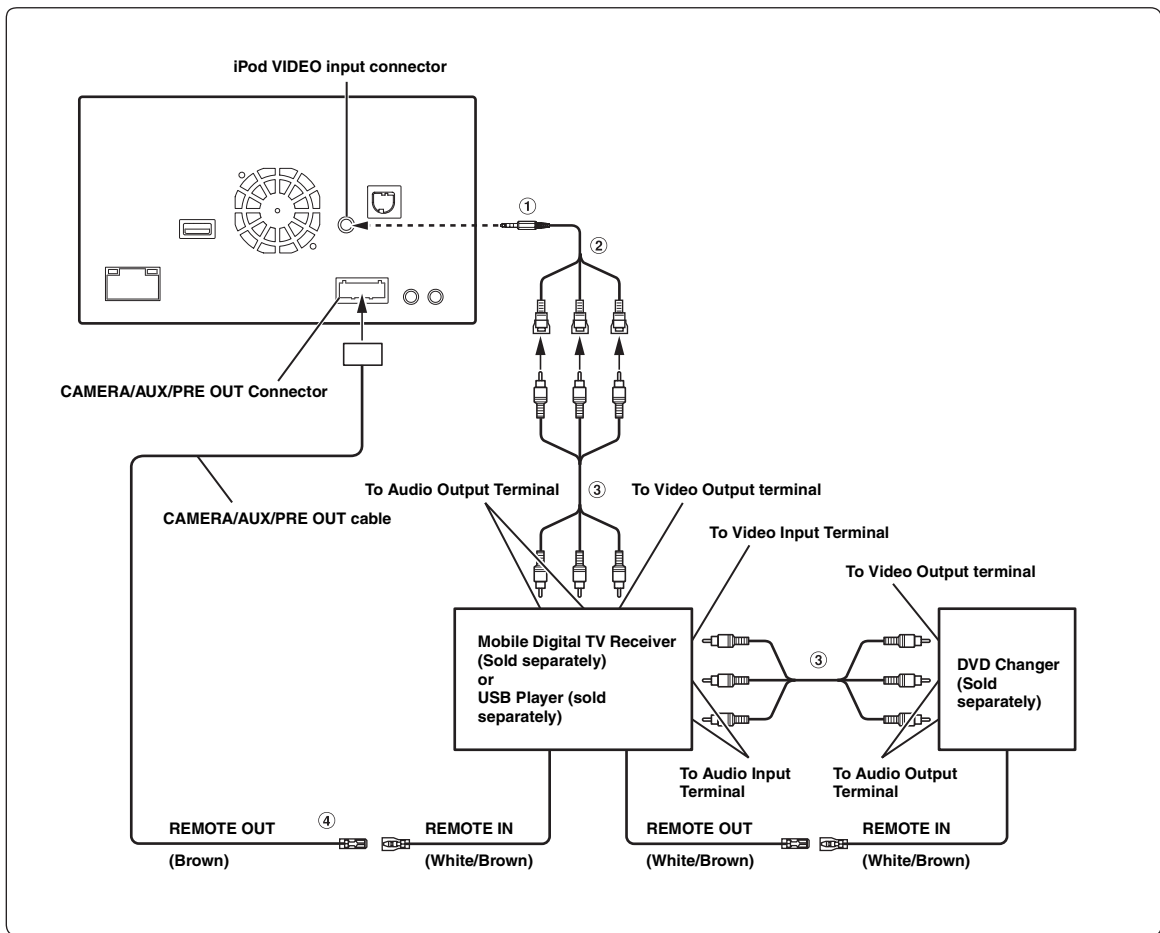

- ① **AV/RCA interface cable (4-pole mini AV plug to 3-RCA) (sold separately)**
- ② **Video/Audio Input Connectors**
YELLOW is for input video, RED is right and WHITE is left input the audio.

- ③ **RCA Extension Cable (Sold Separately)**

- ④ **Remote Control Output Lead (Brown)**
Connect this lead to the remote control input lead. This lead outputs the controlling signals from the remote control.

- You can change the name of an external device. Refer to "Setting the AUX Mode" (page 44).
- You can connect one more external input device only when the "Primary Name" is set to "DVB-T" or "USB-PLAYER." Refer to "Setting the Primary AUX Name (AUX Setup)" (page 44).
- To connect an external input device to the iPod VIDEO connector, set "AUX In" to "AUX." Refer to "Setting the AUX Mode" (page 44).

Connection of a DAB/ DAB+ TUNER

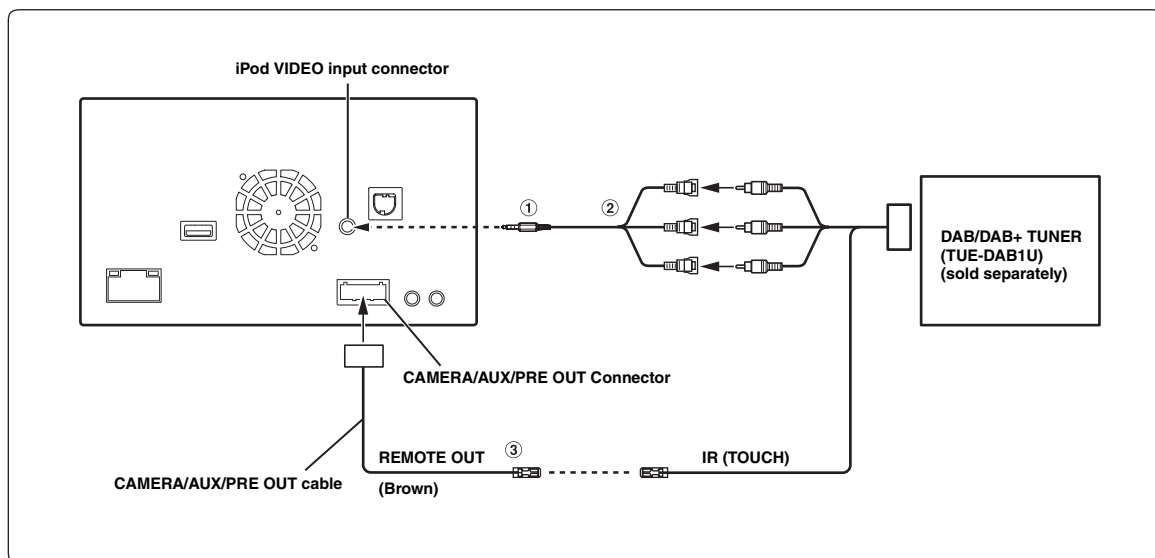

① **AV/RCA interface cable (4-pole mini AV plug to 3-RCA) (sold separately)**

② **Video/Audio Input Connectors**
YELLOW is for input video, RED is right and WHITE is left input the audio.

③ **Remote Control Output Lead (Brown)**
Connect this lead to the remote control input lead. This lead outputs the controlling signals from the remote control.

- You can change the name of an external device. Refer to "Setting the AUX Mode" (page 44).
- To connect an external input device to the iPod VIDEO connector, set "AUX In" to "AUX." Refer to "Setting the AUX Mode" (page 44).

Connection of an External Amplifier

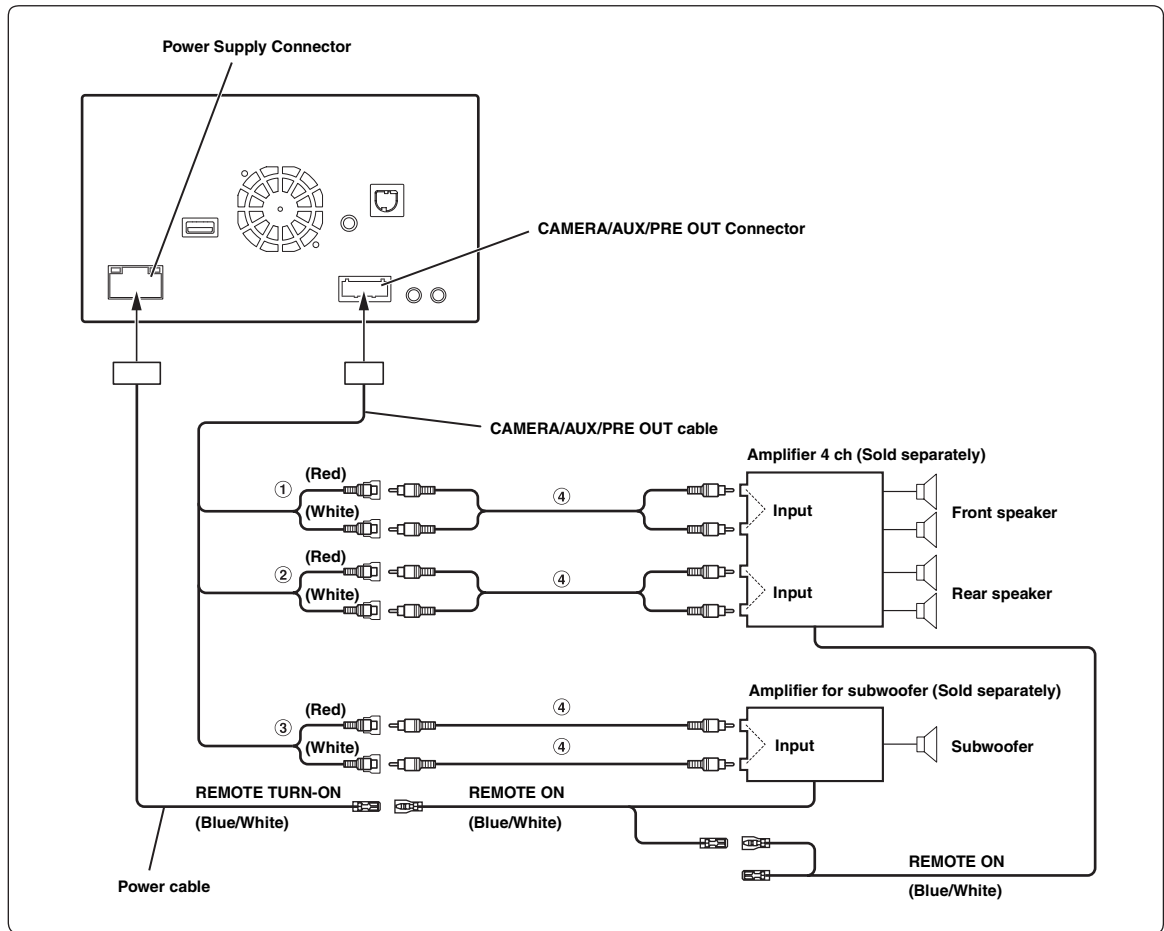

① **Front Output RCA Connectors**

RED is right and WHITE is left.

② **Rear Output RCA Connectors**

RED is right and WHITE is left.

③ **Subwoofer RCA Connector**

④ **RCA Extension Cable (Sold separately)**

Connection of camera

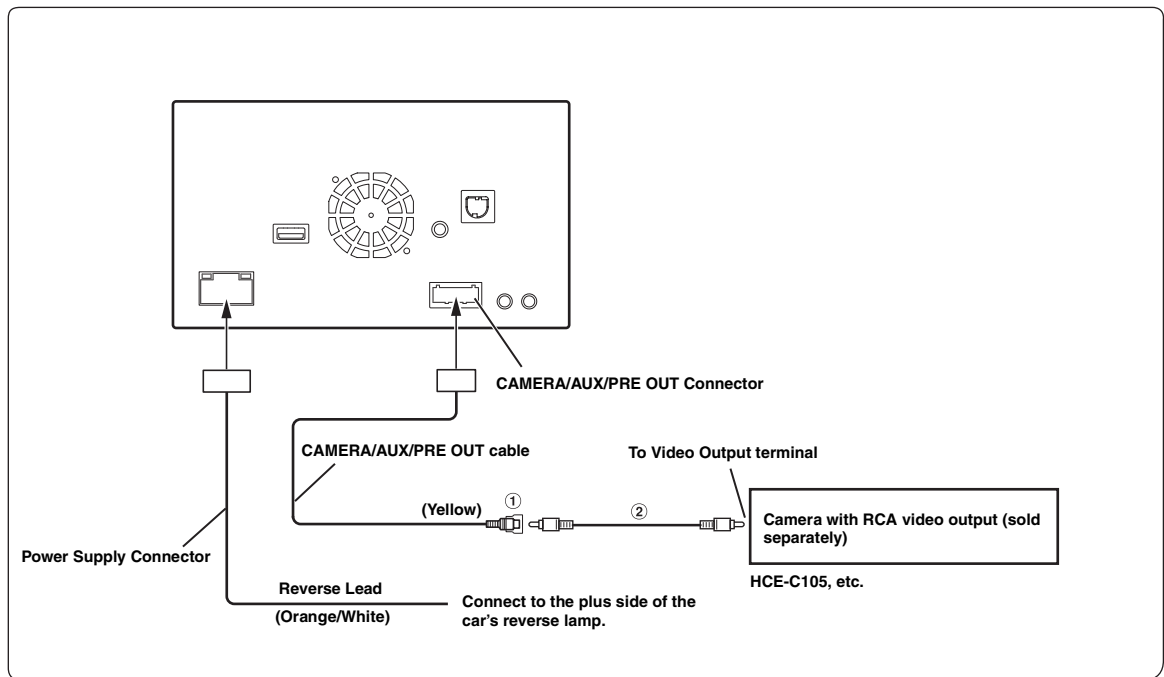

- ① CAMERA Input RCA Connector (CAMERA)
- ② RCA Extension Cable (sold separately)



ALPINE ELECTRONICS, INC.
20-1 Yoshima-Kogyodanchi Iwaki-City Fukushima 970-1192 Japan.
Phone: (+81) 246-36-4111 Fax: (+81) 246-36-6090

Declaration of Conformity

We, the undersigned,

Authorized representative in Europe Alpine Electronics (Europe) Gmb
Address, City Wilhelm-Wagenfeld-Strasse 1-3, D-80807, Munich
Country Germany

certify and declare under our sole responsibility that the following apparatus :

Description MOBILE MEDIA STATION
Manufacturer Alpine Electronics, Inc.
Brand ALPINE
Identification IVE-W585BT
Installed BlueTooth module UGZC-G
Test Report No. Radio :T36209-00-01TK (DAkKS)
EMC :T36209-00-02TK (DAkKS)
LVD :S36208-00-00JK (DAkKS)

conforms with the essential requirements of the Radio and Telecommunications Terminal Equipment Directive 1999/5/EC, based on the following specifications applied:

Radio : EN300328 V1.7.1
EMC : EN301489-1 V1.9.2 EN301 489-17 V2.1.1
LVD : EN 60950-1: 2006 + A1: 2010 + A11: 2009 + A1:2010+A12:2011

and therefore complies with the essential requirements and provisions of the R&TTE Directive.

The Technical documentation is kept at the following address:

Company Alpine Electronics, Inc.
Address, City : 20-1 Yoshima-Kogyodanchi Iwaki-City Fukushima 970-1192 Japan.
Country JAPAN
Phone number (+81) 246-36-4111
Fax number (+81) 246-36-6090
Name and position of person Mitsuru Yoshida
binding the manufacturer or his Global Engineering Strategy Office
authorized representative Alpine Electronics, Inc.

Signature of the authorized person : M. Yoshida.

:Date of issue December 24, 2013